

SERVICE MANUAL

BA-5 CHASSIS

<u>MODEL NAME</u>	<u>REMOTE COMMANDER</u>	<u>DESTINATION</u>	<u>CHASSIS NO.</u>
KV-27FS13	RM-Y180	USA	SCC-S40NA
KV-27FS13	RM-Y180	CND	SCC-S41LA
KV-27FS17	RM-Y181	USA	SCC-S40PA
KV-27FV17	RM-Y181	USA	SCC-S40MA
KV-27FV17	RM-Y181	CND	SCC-S41KA
KV-29FV17	RM-Y181	E	SCC-S38XA
KV-29FV17C	RM-Y181	E	SCC-S38YA
KV-32FS13	RM-Y180	USA	SCC-S40QA
KV-32FS13	RM-Y180	CND	SCC-S41MA
KV-32FS17	RM-Y181	USA	SCC-S40RA
KV-34FS13C	RM-Y180	E	SCC-S56DA
KV-34FS17	RM-Y181	E	SCC-S56JA



KV-27FV17



KV-27FS17



RM-Y181

TRINITRON® COLOR TELEVISION

SONY®

TABLE OF CONTENTS

SECTION TITLE	PAGE
Specifications.....	3
Warnings and Cautions.....	4
Safety Check-Out.....	5
Self-Diagnostic Function.....	6
1. Disassembly	
1-1. Rear Cover Removal.....	8
1-2. Chassis Assembly Removal.....	8
1-3. Service Position	8
1-4. Picture Tube Removal	9
Anode Cap Removal Procedure.....	9
2. Set-Up Adjustments	
2-1. Beam Landing.....	10
2-2. Convergence.....	11
2-3. Focus	12
2-4. Screen (G2)	12
2-5. Method of Setting the Service Adjustment Mode.....	13
2-6. White Balance Adjustments	13
3. Safety Related Adjustments	
3-1.  R564 Confirmation Method (Hold Down Confirmation) and Readjustments.....	14
3-2. B+ Voltage Confirmation and Adjustment	14
4. Circuit Adjustments	
4-1. Setting the Service Adjustment Mode.....	16
4-2. Memory Write Confirmation Method	16
4-3. Remote Adjustment Buttons and Indicators	16
4-4. MA Board Adjustments	21
5. Diagrams	
5-1. Circuit Boards Location.....	23
5-2. Printed Wiring Board and Schematic Diagram Information	24
5-3. Block Diagram and Schematics	25
A Board	31
BC Board.....	36
CA Board.....	39
D Board	41
HA Board.....	43
HB Board.....	44
HX Board.....	44
K Board	45
MA Board	47
P Board	52
VA Board	53
5-4. Semiconductors	55
6. Exploded Views	
6-1. Chassis (KV-27FV17/29FV17/29FV17C ONLY)	56
6-2. Picture Tube Removal (KV-27FV17/29FV17/29FV17C ONLY)	57
6-3. Chassis (KV-27FS13/27FS17 ONLY)	58
6-4. Chassis (KV-32FS13/32FS17/34FS13C/34FS17 ONLY).....	59
6-5. Picture Tube Removal (KV-27FS13/27FS17/32FS13/32FS17/34FS13C/34FS17 ONLY)	60
7. Electrical Parts List	61

SPECIFICATIONS

	KV-27FV17/ 29FV17	KV-29FV17C	KV-27FS13	KV-27FS17	KV-32FS13	KV-34FS13C	KV-32FS17/ 34FS17
Power requirements	120V, 60 Hz	220V, 50 Hz	120V, 60 Hz	120V, 60 Hz	120V, 60 Hz	220V, 50 Hz	120V, 60 Hz
Number of inputs/outputs							
Video ¹⁾	3	3	3	3	3	3	3
S Video ²⁾	2	2	1	1	1	1	1
Audio ³⁾	3	3	3	3	3	3	3
Audio Out ⁴⁾	1	1	1	1	1	1	1
Y, P _B , P _R ⁵⁾	1	1	1	1	1	1	1
Monitor Out	1	1	--	--	--	--	--
Speaker output(W)	15W x 2	15W x 2	7.5W x 2	7.5W x 2	10W x 2	10W x 2	10W x 2
Power Consumption(W)							
In use(Max)	220W	210W	170W	180W	195W	195W	205W
In standby	1W	1W	1W	1W	1W	1W	1W
Dimensions(W/H/D)							
(mm)	762 x 604 x 519 mm	762 x 604 x 519 mm	700 x 632 x 512 mm	762 x 604 x 519 mm	800 x 704 x 582 mm	700 x 632 x 512 mm	762 x 604 x 519 mm
(in)	30 x 23 ^{7/8} x 20 ^{1/2} in.	30 x 23 ^{7/8} x 20 ^{1/2} in.	27 ^{5/8} x 25 x 20 ^{1/4} in.	30 x 23 ^{7/8} x 20 ^{1/2} in.	31 ^{1/2} x 27 ^{3/4} x 23 in.	27 ^{5/8} x 25 x 20 ^{1/4}	30 x 23 ^{7/8} x 20 ^{1/2} in.
Mass							
(kg)	49 kg.	49 kg.	47 kg.	49 kg.	75 kg.	75 kg.	75 kg.
(lbs)	108 lbs.	108 lbs.	103 lbs. 10 oz.	108 lbs.	163 lbs.	163 lbs.	163 lbs.

Television system

American TV Standard/NTSC

Channel coverage

VHF: 2-13/ VHF: 14-69/ CATV: 1-125

Picture tube

Flat Trinitron[®] tube

Visible screen size

27-inch picture measured diagonally (KV-27FS13/27FS17/27FV17/29FV17/29FV17C ONLY)

32-inch picture measured diagonally (KV-32FS13/32FS17/34FS13C/34FS17 ONLY)

Actual screen size

29-inch measured diagonally (KV-27FS13/27FS17/27FV17/29FV17/29FV17C ONLY)

34-inch measured diagonally (KV-32FS13/32FS17/34FS13C/34FS17 ONLY)

Antenna

75 ohm external terminal for VHF/UHF

Supplied Accessories

Remote Commander RM-Y180 (KV-27FS13/32FS13/34FS13C ONLY)

Remote Commander RM-Y181 (KV-27FS17/27FV17/29FV17/29FV17C/32FS17/34FS17 ONLY)

Size AA (R6) batteries (2)

Optional Accessories

Connecting cables: VMC-810S/820S, VMC-720M,

YC-15V/30V, RK74A

UV mixer EAC-66

TV Stand: SU-27FD4 (KV-27FS13/ 27FS17/ 27FV17 ONLY)

TV Stand: SU-27FD3 (KV-29FV17/ 29FV17C ONLY)

TV Stand: SU-32FD3 (KV-34FS17/34FS13C ONLY)

TV Stand: SU-32FD4 (KV-32FS13/ 32FS17 ONLY)

1) 1 Vp-p 75 ohms unbalanced, sync negative

2) Y: 1 Vp-p 75 ohms unbalanced, sync negative

C: 0.286 Vp-p (Burst signal), 75 ohms

3) 500 mVrms (100% modulation), Impedance: 47 kilohms

4) More than 408 mVrms at the maximum volume setting (variable)

More than 408 mVrms (fix); Impedance (output): 2 kilohms

5) Y: 1.0 Vp-p, 75 ohms, sync negative; P_B: 0.7 Vp-p, 75 ohms

P_R: Vp-p, 75 ohms

(●) SRS (SOUND RETRIEVAL SYSTEM)

The (●) SRS (SOUND RETRIEVAL SYSTEM) is manufactured by Sony Corporation under license from SRS Labs, Inc. It is covered by U.S. Patent No. 4,748,669. Other U.S. and foreign patents pending.

The word 'SRS' and the SRS symbol (●) are registered trademarks of SRS Labs, Inc. BBE and BBE symbol are trademarks of BBE Sound, Inc. and are licensed by BBE Sound, Inc. under U.S. Patent No. 4,638,258.

Design and specifications are subject to change without notice.

WARNINGS AND CAUTIONS

CAUTION

Short circuit the anode of the picture tube and the anode cap to the metal chassis, CRT shield, or carbon painted on the CRT, after removing the anode.

WARNING!!

An isolation transformer should be used during any service to avoid possible shock hazard, because of live chassis. The chassis of this receiver is directly connected to the AC power line.

SAFETY-RELATED COMPONENT WARNING!!

Components identified by shading and  mark on the schematic diagrams, exploded views, and in the parts list are critical for safe operation. Replace these components with Sony parts whose part numbers appear as shown in this manual or in supplements published by Sony. Circuit adjustments that are critical for safe operation are identified in this manual. Follow these procedures whenever critical components are replaced or improper operation is suspected.

ATTENTION!!

Après avoir déconnecté le cap de l'anode, court-circuiter l'anode du tube cathodique et celui de l'anode du cap au châssis métallique de l'appareil, ou la couche de carbone peinte sur le tube cathodique ou au blindage du tube cathodique.

Afin d'éviter tout risque d'électrocution provenant d'un châssis sous tension, un transformateur d'isolement doit être utilisé lors de tout dépannage. Le châssis de ce récepteur est directement raccordé à l'alimentation du secteur.

ATTENTION AUX COMPOSANTS RELATIFS A LA SECURITE!!

Les composants identifiés par une trame et par une marque  sur les schémas de principe, les vues explosées et les listes de pièces sont d'une importance critique pour la sécurité du fonctionnement. Ne les remplacer que par des composants Sony dont le numéro de pièce est indiqué dans le présent manuel ou dans des suppléments publiés par Sony. Les réglages de circuit dont l'importance est critique pour la sécurité du fonctionnement sont identifiés dans le présent manuel. Suivre ces procédures lors de chaque remplacement de composants critiques, ou lorsqu'un mauvais fonctionnement suspecte.

SAFETY CHECK-OUT

After correcting the original service problem, perform the following safety checks before releasing the set to the customer:

1. Check the area of your repair for unsoldered or poorly soldered connections. Check the entire board surface for solder splashes and bridges.
2. Check the interboard wiring to ensure that no wires are "pinched" or touching high-wattage resistors.
3. Check that all control knobs, shields, covers, ground straps, and mounting hardware have been replaced. Be absolutely certain that you have replaced all the insulators.
4. Look for unauthorized replacement parts, particularly transistors, that were installed during a previous repair. Point them out to the customer and recommend their replacement.
5. Look for parts which, though functioning, show obvious signs of deterioration. Point them out to the customer and recommend their replacement.
6. Check the line cords for cracks and abrasion. Recommend the replacement of any such line cord to the customer.
7. Check the B+ and HV to see if they are specified values. Make sure your instruments are accurate; be suspicious of your HV meter if sets always have low HV.
8. Check the antenna terminals, metal trim, "metallized" knobs, screws, and all other exposed metal parts for AC leakage. Check leakage as described below.

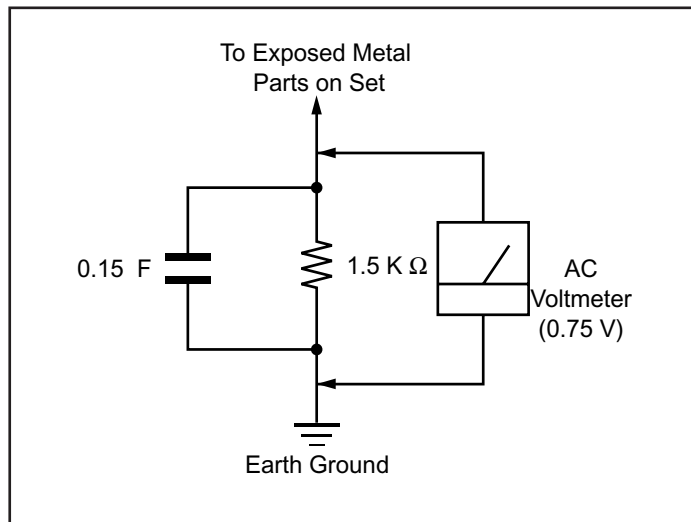

Figure A. Using an AC voltmeter to check AC leakage.

Leakage Test

The AC leakage from any exposed metal part to earth ground and from all exposed metal parts to any exposed metal part having a return to chassis, must not exceed 0.5 mA (500 microamperes). Leakage current can be measured by any one of three methods.

1. A commercial leakage tester, such as the Simpson 229 or RCA WT-540A. Follow the manufacturers' instructions to use these instructions.
2. A battery-operated AC milliampmeter. The Data Precision 245 digital multimeter is suitable for this job.
3. Measuring the voltage drop across a resistor by means of a VOM or battery-operated AC voltmeter. The "limit" indication is 0.75 V, so analog meters must have an accurate low voltage scale. The Simpson's 250 and Sanwa SH-63TRD are examples of passive VOMs that are suitable. Nearly all battery-operated digital multimeters that have a 2 VAC range are suitable (see Figure A).

How to Find a Good Earth Ground

A cold-water pipe is a guaranteed earth ground; the cover-plate retaining screw on most AC outlet boxes is also at earth ground. If the retaining screw is to be used as your earth ground, verify that it is at ground by measuring the resistance between it and a cold-water pipe with an ohmmeter. The reading should be zero ohms.

If a cold-water pipe is not accessible, connect a 60- to 100-watt trouble-light (not a neon lamp) between the hot side of the receptacle and the retaining screw. Try both slots, if necessary, to locate the hot side on the line; the lamp should light at normal brilliance if the screw is at ground potential (see Figure B).

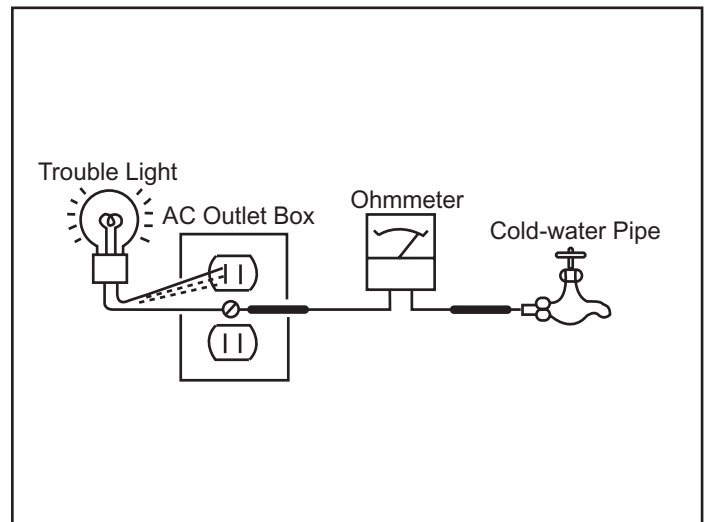

Figure B. Checking for earth ground.

SELF-DIAGNOSTIC FUNCTION

Self Diagnosis
Supported model

The units in this manual contain a self-diagnostic function. If an error occurs, the STANDBY/TIMER LED will automatically begin to flash. The number of times the LED flashes translates to a probable source of the problem. A definition of the STANDBY/TIMER LED flash indicators is listed in the instruction manual for the user's knowledge and reference. If an error symptom cannot be reproduced, the Remote Commander can be used to review the failure occurrence data stored in memory to reveal past problems and how often these problems occur.

Diagnostic Test Indicators

When an error occurs, the STANDBY/TIMER LED will flash a set number of times to indicate the possible cause of the problem. If there is more than one error, the LED will identify the first of the problem areas.

Results for all of the following diagnostic items are displayed on screen. No error has occurred if the screen displays "0".

Diagnostic Item Description	No. of times STANDBY/ TIMER lamp flashes	Self-Diagnostic Display/ Diagnostic Result	Probable Cause Location	Detected Symptoms
Power does not turn on	Does not light	—————	<ul style="list-style-type: none"> Power cord is not plugged in. Fuse is burned out (F601). (A Board) 	<ul style="list-style-type: none"> Power does not come on. No power is supplied to the TV. AC Power supply is faulty.
+B overcurrent (OCP)*	2 times	2:0 or 2:1	<ul style="list-style-type: none"> H.OUT (Q502) is shorted. (A Board) IC702 is shorted. (CA Board) 	<ul style="list-style-type: none"> Power does not come on. Load on power line is shorted.
I-Prot	4 times	4:0 or 4:1	<ul style="list-style-type: none"> +13V is not supplied. (A Board) IC502 is faulty. (A Board) 	<ul style="list-style-type: none"> Has entered standby state after horizontal raster. Vertical deflection pulse is stopped. Power line is shorted or power supply is stopped.
IK (AKB)	5 times	5:0 or 5:1	<ul style="list-style-type: none"> Viedo OUT (IC502) is faulty. (A Board) IC301 is faulty. (MA Board) Screen (G2) is improperly adjusted.** 	<ul style="list-style-type: none"> No raster is generated. CRT Cathode current detection reference pulse output is small.

*If a +B overcurrent is detected, stoppage of the vertical deflection is detected simultaneously. The symptom that is diagnosed first by the microcontroller is displayed on the screen.

**Refer to Screen (G2) Adjustments in Section 2-4. of this manual.

Display of Standby/Timer LED Flash Count

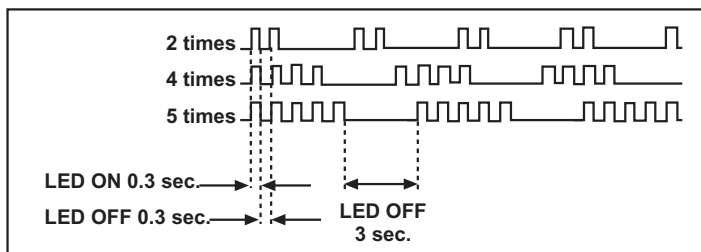

Diagnostic Item	Flash Count*
+B Overcurrent	2 times
I-Prot	4 times
IK (AKB)	5 times

*One flash count is not used for self-diagnostic.

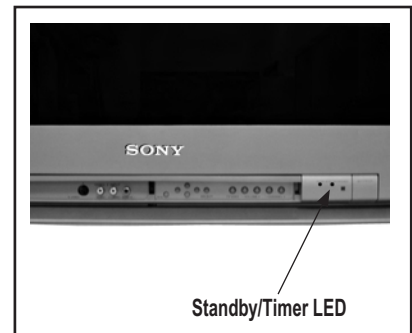

Stopping the Standby/Timer LED Flash

Turn off the power switch on the TV main unit or unplug the power cord from the outlet to stop the STANDBY/TIMER LAMP from flashing.

Self-Diagnostic Screen Display

For errors with symptoms such as “power sometimes shuts off” or “screen sometimes goes out” that cannot be confirmed, it is possible to bring up past occurrences of failure on the screen for confirmation.

To Bring Up Screen Test

In standby mode, press buttons on the Remote Commander sequentially, in rapid succession, as shown below:

Display Channel Sound Volume Power ON

Note that this differs from entering the Service Mode (Sound Volume).

Self-Diagnostic Screen Display

SELF DIAGNOSTIC
2: 000
3: N/A
4: 000
5: 001
101: N/A

Numeral “0” means that no fault was detected.
Numerical “1” means a fault was detected one time only.

Handling of Self-Diagnostic Screen Display

Since the diagnostic results displayed on the screen are not automatically cleared, always check the self-diagnostic screen during repairs. When you have completed the repairs, clear the result display to “0”.

Unless the result display is cleared to “0”, the self-diagnostic function will not be able to detect subsequent faults after completion of the repairs.

Clearing the Result Display

To clear the result display to “0”, press buttons on the Remote Commander sequentially when the diagnostic screen is displayed, as shown below:

Channel ENTER

Quitting the Self-Diagnostic Screen

To quit the entire self-diagnostic screen, turn off the power switch on the Remote Commander or the main unit.

Self-Diagnostic Circuit

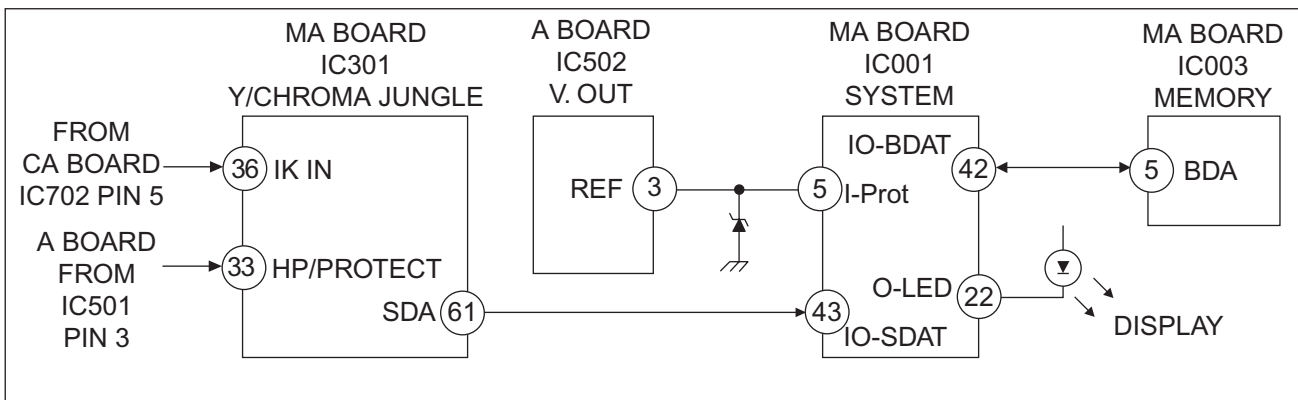

+B overcurrent (OCP)

Occurs when an overcurrent on the +B (135V) line is detected by pin 33 of IC301 (MA Board). If the voltage of pin 33 of IC301 (MA Board) is less than 1V when V.SYNC is more than seven verticals in a period, the unit will automatically turn off.

I-Prot

Occurs when an absence of the vertical deflection pulse is detected by pin 5 of IC001 (MA Board). Power supply will shut down when waveform interval exceeds 2 seconds.

IK (AKB)

If the RGB levels* do not balance within 2 seconds after the power is turned on, this error will be detected by IC301 (MA Board). TV will stay on, but there will be no picture.

*(Refers to the RGB levels of the AKB detection Ref pulse that detects 1K).

SECTION 1: DISASSEMBLY

1-1. REAR COVER REMOVAL

KV-27FS13/27FS17/27FV17/29FV17/29FV17C

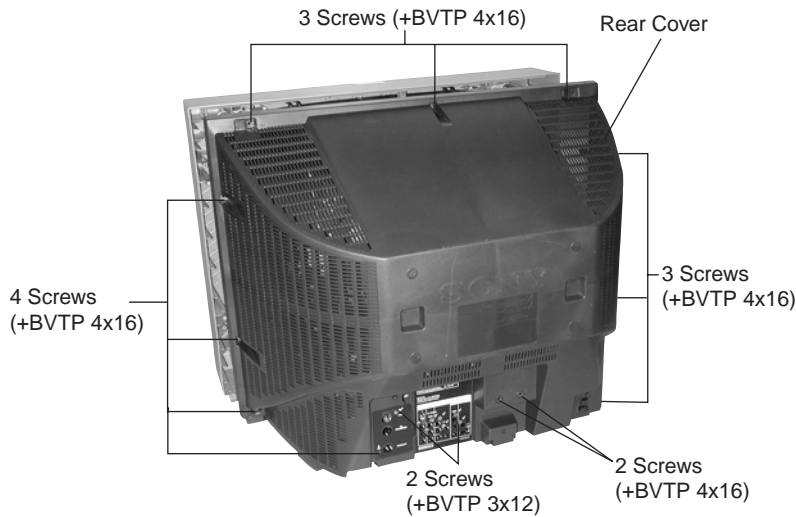

KV-32FS13/32FS17/34FS13C/34FS17 ONLY

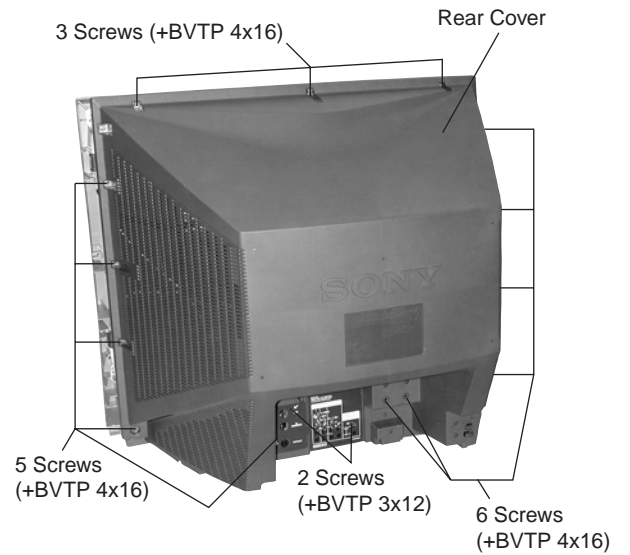

1-2. CHASSIS ASSEMBLY REMOVAL

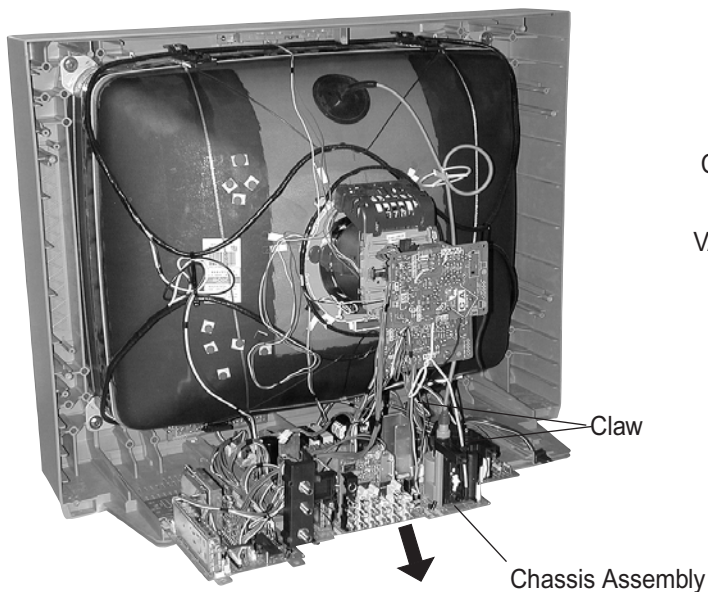

1-3. SERVICE POSITION

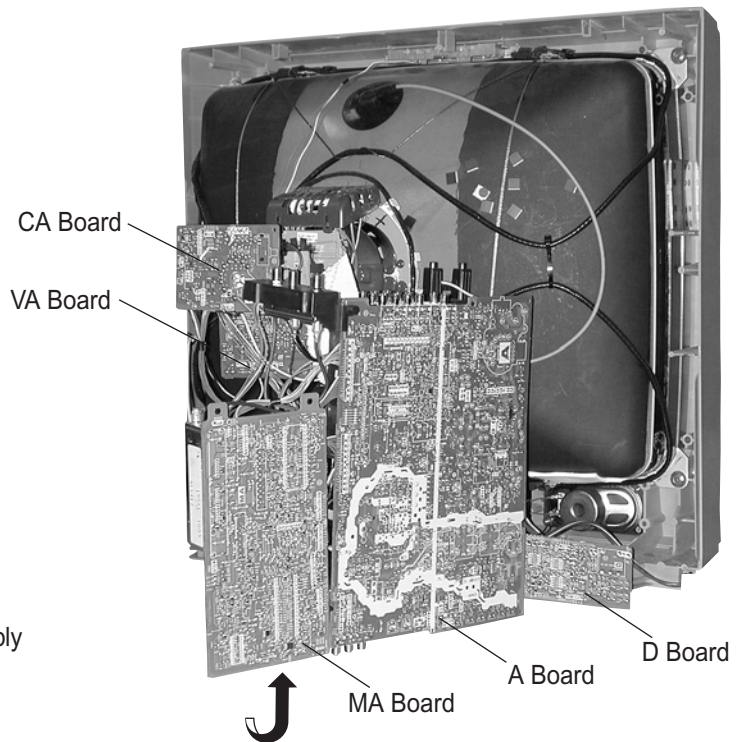

1-4. PICTURE TUBE REMOVAL

WARNING: BEFORE REMOVING THE ANODE CAP

High voltage remains in the CRT even after the power is disconnected. To avoid electric shock, discharge CRT before attempting to remove the anode cap. Short between anode and CRT coated earth ground strap.

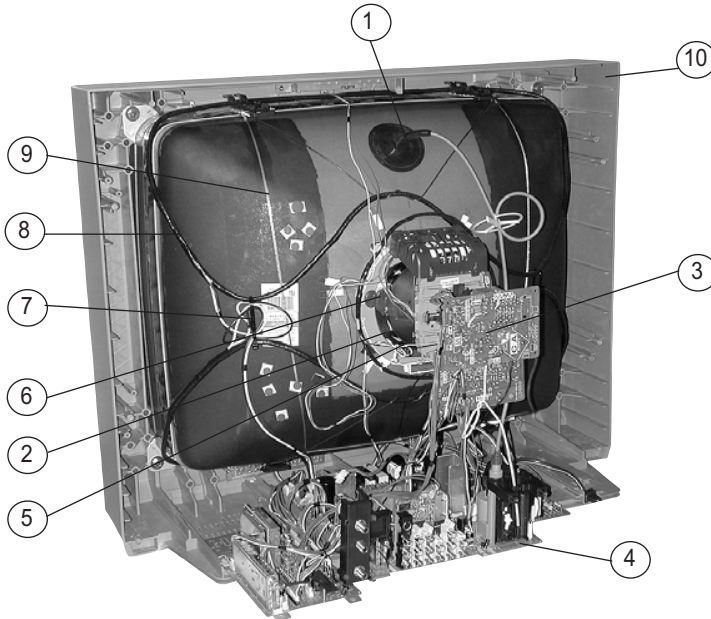
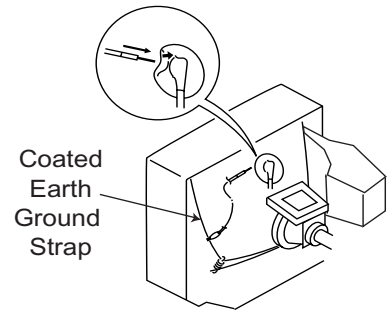

1. Discharge the anode of the CRT and remove the anode cap.
2. Unplug all interconnecting leads from the deflection yoke, neck assembly, degaussing coils and CRT grounding strap.
3. Remove the CA and VA Board from the CRT.
4. Remove the chassis assembly.
5. Loosen the neck assembly fixing screw and remove.
6. Loosen the deflection yoke fixing screw and remove.
7. Place the set with the CRT face down on a cushion and remove the degaussing coil holders.
8. Remove the degaussing coils.
9. Remove the CRT grounding strap and spring tension devices.
10. Unscrew the four CRT fixing screws [located on each CRT corner] and remove the CRT [Take care not to handle the CRT by the neck].

ANODE CAP REMOVAL PROCEDURE

WARNING: High voltage remains in the CRT even after the power is disconnected. To avoid electric shock, discharge CRT **before** attempting to remove the anode cap. Short between anode and coated earth ground strap of CRT.

NOTE: After removing the anode cap, short circuit the anode of the picture tube and the anode cap to either the metal chassis, CRT shield, or carbon painted on the CRT.

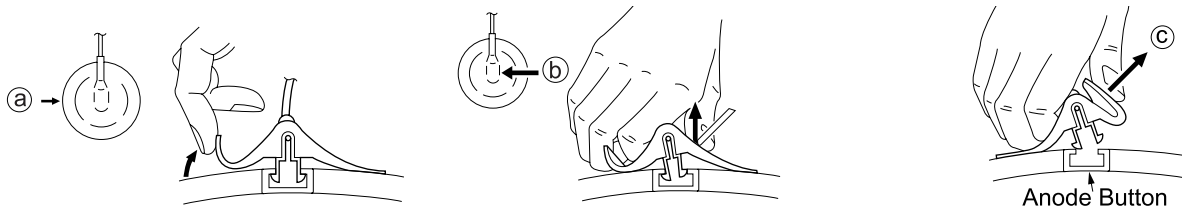

① Turn up one side of the rubber cap in the direction indicated by arrow (a) .

② Use your thumb to pull the rubber cap firmly in the direction indicated by arrow (b) .

③ When one side of the rubber cap separates from the anode button, the anode cap can be removed by turning the rubber cap and pulling it in the direction of arrow (c) .

HOW TO HANDLE AN ANODE CAP

1. Do not use sharp objects which may cause damage to the surface of the anode cap.
2. To avoid damaging the anode cap, do not squeeze the rubber covering too hard. A material fitting called a shatter-hook terminal is built into the rubber.
3. Do not force turn the foot of the rubber cover. This may cause the shatter-hook terminal to protrude and damage the rubber.

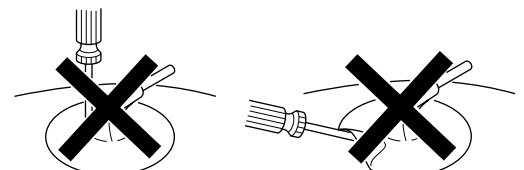

SECTION 2: SET-UP ADJUSTMENTS

The following adjustments should be made when a complete realignment is required or a new picture tube is installed.

These adjustments should be performed with rated power supply voltage unless otherwise noted.

Set the controls as follows unless otherwise noted:

VIDEO MODE: Standard

PICTURE CONTROL: Normal

BRIGHTNESS CONTROL: Normal

Perform the adjustments in order as follows:

1. Beam Landing
2. Convergence
3. Focus
4. Screen (G2)
5. White Balance

Note Test Equipment Required:

1. Color Bar Pattern Generator
2. Degausser
3. DC Power Supply
4. Digital Multimeter

2-1. BEAM LANDING

Before beginning adjustment procedure:

1. Degauss the entire screen.
2. Feed in the white pattern signal.

ADJUSTMENT PROCEDURE

1. Input a raster signal with the pattern generator.
2. Loosen the deflection yoke mounting screw, and set the purity control to the center as shown below:

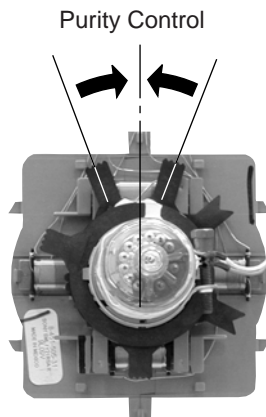

3. Turn the raster signal of the pattern generator to green.
4. Move the deflection yoke backward, and adjust with the purity control so that green is in the center and red and blue are even on both sides.

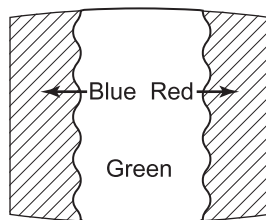

5. Move the deflection yoke forward, and adjust so that the entire screen becomes green.

6. Switch over the raster signal to red and blue and confirm the condition.
7. When the position of the deflection yoke is determined, tighten it with the deflection yoke mounting screw.
8. If landing at the corner is not right, adjust by using the disk magnets.

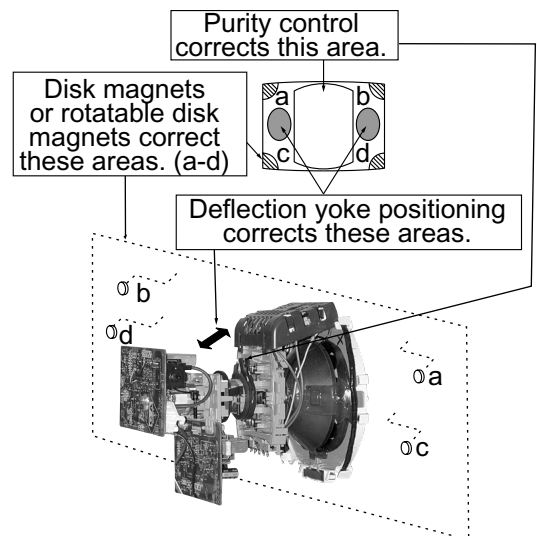
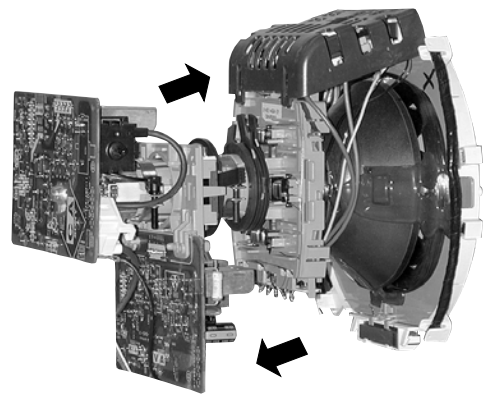

2-2. CONVERGENCE

Before starting convergence adjustments:

- 1 Perform FOCUS, VLIN and VSIZE adjustments.
2. Set BRIGHTNESS control to minimum.
3. Feed in dot pattern.

VERTICAL STATIC CONVERGENCE

1. Adjust V. STAT magnet to converge red, green and blue dots in the center of the screen (Vertical movement adjusts V.STAT RV701 to converge).

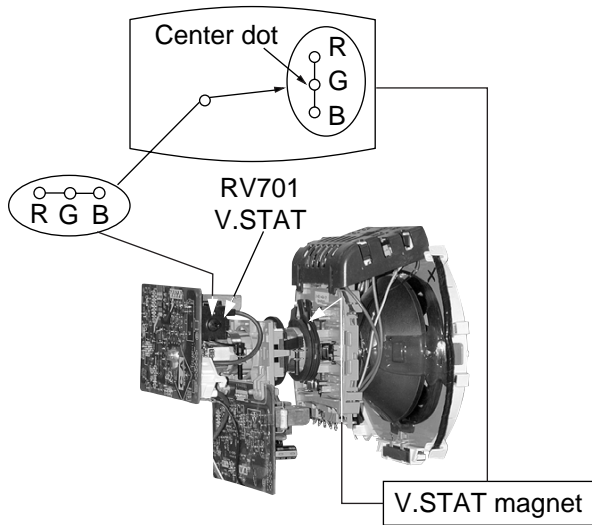

2. Tilt the V. STAT magnet and adjust static convergence to open or close the V. STAT magnet.

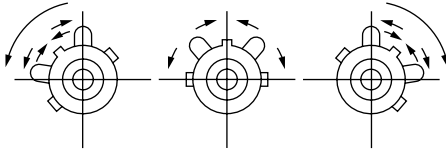

When the V. STAT magnet is moved in the direction of arrow a and b, red, green, and blue dots move as shown below:

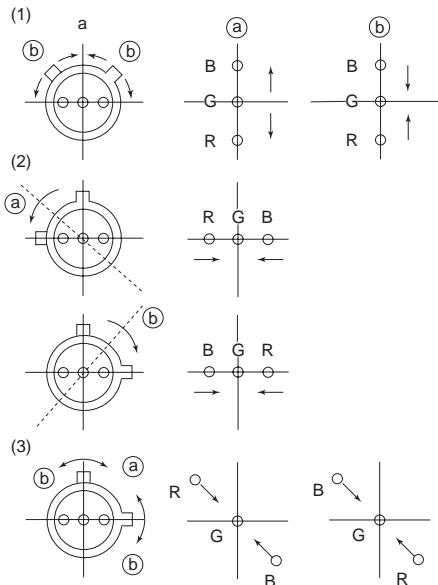

HORIZONTAL STATIC CONVERGENCE

If the blue dot does not converge with the red and green dots, perform the following:

1. Move BMC magnet (a) to correct insufficient H.Static convergence.
2. Rotate BMC magnet (b) to correct insufficient V.Static convergence.
3. After adjusting the BMC magnet, repeat Beam Landing Adjustment.

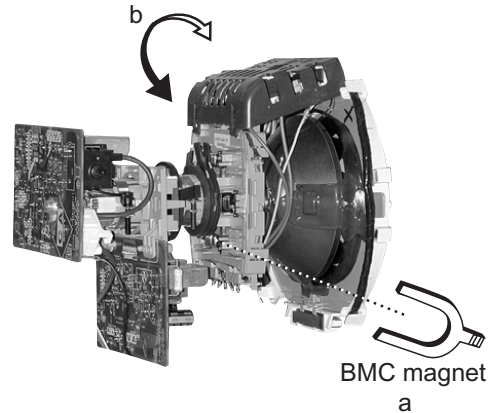
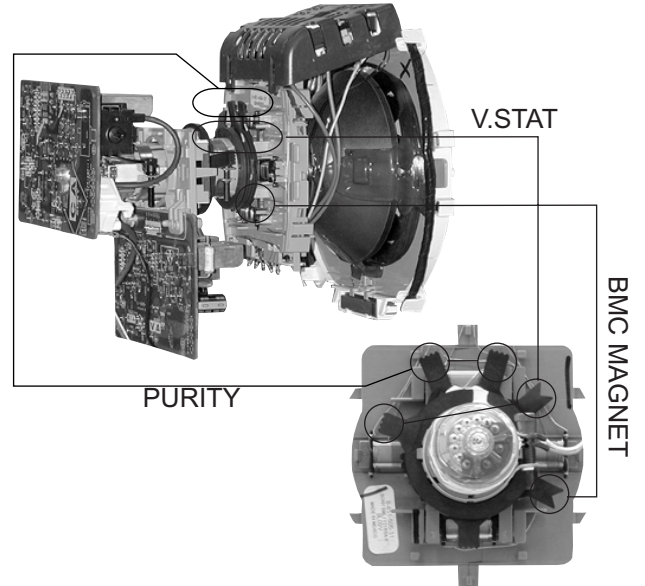

DYNAMIC CONVERGENCE ADJUSTMENT

Before performing this adjustment, perform Horizontal and Vertical Static Convergence Adjustment.

1. Slightly loosen deflection yoke screw.
2. Remove deflection yoke spacers.
3. Move the deflection yoke for best convergence as shown below:

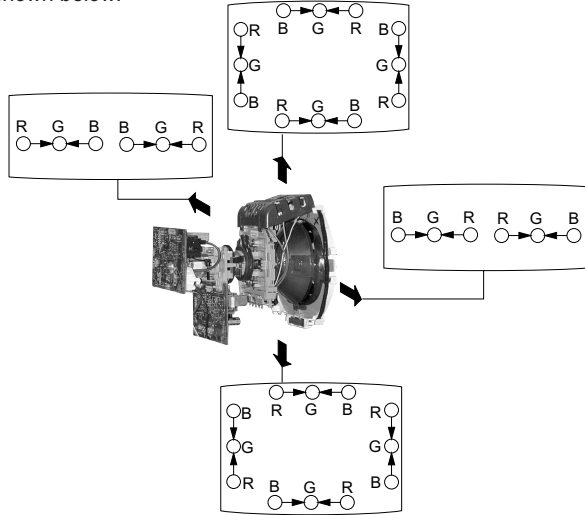

4. Tighten the deflection yoke screw.
5. Install the deflection yoke spacers.

TLH PLATE ADJUSTMENT

1. Input crosshatch pattern.
2. Adjust PICTURE QUALITY to standard, PICTURE and BRIGHTNESS to 50%, and OTHER to standard.
3. Adjust the Horizontal Convergence of red and blue dots by tilting the TLH plate on the deflection yoke.

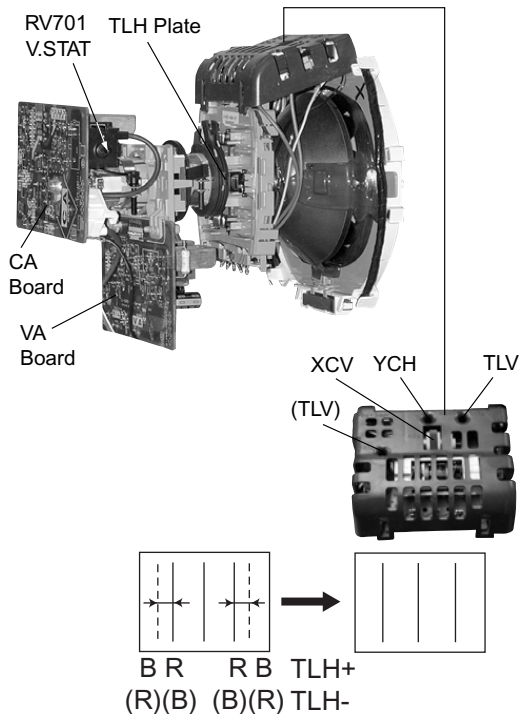

4. Adjust XCV core to balance X axis.
5. Adjust YCH VR to balance Y axis.
6. Adjust vertical red and blue convergence with V.TILT (TLV VR).
Note: Perform adjustment 3-6 while tracking items 1 and 2.

SCREEN-CORNER CONVERGENCE

1. Affix a permalloy assembly corresponding to the misconverged areas:

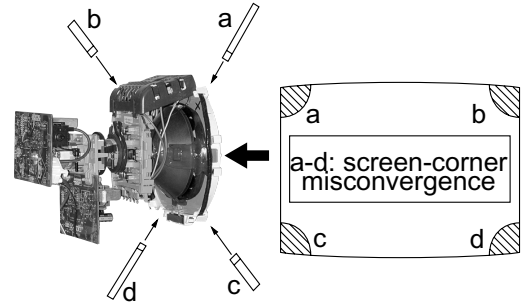

2-3. FOCUS

1. Adjust FOCUS control for best pictures.

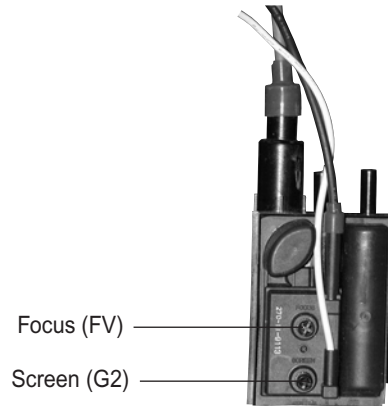

2-4. SCREEN (G2)

1. Input a dot pattern.
2. Set the PICTURE and BRIGHTNESS controls at minimum and COLOR control at normal.
3. Adjust SBRT, GCUT, BCUT in service mode with an oscilloscope as shown below so that voltages on the red, green, and blue cathodes are 170 ± 2 VDC.

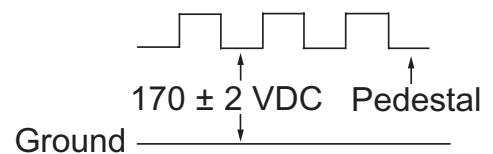

2-5. METHOD OF SETTING THE SERVICE ADJUSTMENT MODE

SERVICE MODE PROCEDURE

- Standby mode (power off).
- Press **[Display]** → Channel **[5]** → Sound Volume **[+]** → Power on the Remote Commander (press each button within a second).

SERVICE ADJUSTMENT MODE ON

- The CRT displays the time being adjusted.

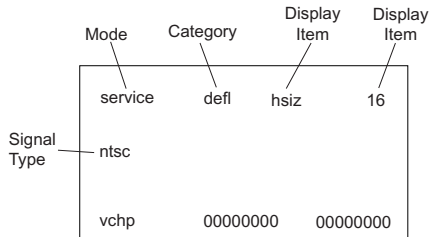

- Press **[1]** or **[4]** on the Remote Commander to select the time.
- Press **[3]** or **[6]** on the Remote Commander to change the data.
- Press **[MUTING]** then **[ENTER]** to save into the memory.

SERVICE ADJUSTMENT MODE MEMORY

Turn the set off then on to exit Service Adjustment Mode.

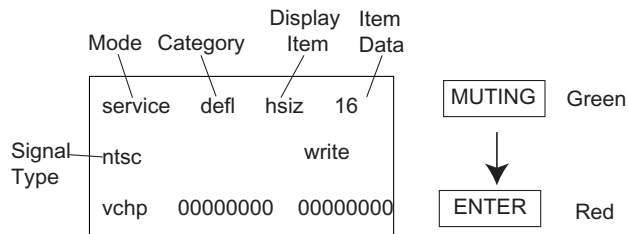



2-6. WHITE BALANCE ADJUSTMENTS

- Input an entire white signal with burst.
- Set to Service Adjustment Mode.
- Set the PICTURE and BRIGHTNESS to minimum.
- Adjust with SBRT if necessary.
- Select GCUT and BCUT with **[1]** and **[4]**.
- Adjust with **[3]** and **[6]** for the best white balance.
- Set the PICTURE and BRIGHTNESS to maximum.
- Select GDRV and BDRV with **[1]** and **[4]**.
- Adjust with **[3]** and **[6]** for the best white balance.
- To write into memory, press **[MUTING]** then **[ENTER]**.

SECTION 3: SAFETY RELATED ADJUSTMENTS

3-1. R564 CONFIRMATION METHOD (HOLD-DOWN CONFIRMATION) AND READJUSTMENTS

The following adjustments should always be performed when replacing the following components which are marked with  on the schematic diagram:

Part Replaced ()	Adjustment ()
DY, T505, CRT, IC501 C507, C520, C505, C509, C515, T504, T503, C551, L510, C546, C537, C547, D517, D518, D519, R560, R561, R562, R563, R565, R566, R567, R525.....A Board IC301.....MA Board	HV HOLD-DOWN R564

PREPARATION BEFORE CONFIRMATION

- Using a Variac, apply AC input voltage: 120 ± 2 VAC.
- Turn the POWER switch ON.
- Input a white signal and set the PICTURE and BRIGHTNESS controls to maximum.
- Confirm that the voltage between C546 (+) or TP503 and ground is more than 21.0 VDC (27/29 inch) or 23.0 VDC (32/34 inch).

HOLD-DOWN OPERATION CONFIRMATION

- Connect the current meter between Pin 11 of the FBT (T505) and the PWB land where Pin 11 would normally attach (See Figure 1 on the next page).
- Input a dot signal and set PICTURE and BRIGHTNESS to minimum: IABL = $1730 \pm 100\mu\text{A}$. (27/29 inch) or $2175 +100 - 325\mu\text{A}$ (32/34inch).
- Confirm the voltage of A Board TP-600 is 135 ± 1.5 VDC.
- Connect the digital voltmeter and the DC power supply via Diode 1SS119 to C546 (+) and ground (See Figure 1 on next page).
- Increase the DC power voltage gradually until the picture blanks out.
- Turn DC power source off immediately.
- Read the digital voltmeter indication (standard $24.78 +0/ -0.1$ VDC [27/29 inch] or $27.24 +0/-0.1$ VDC [32/34 inch]).
- Input a white signal and set PICTURE and BRIGHTNESS to maximum: IABL = $1730 \pm 100\mu\text{A}$ (27/29 inch) or $2175 +100/-325 \mu\text{A}$ (32/34 inch).
- Repeat steps 4 to 7.

HOLD-DOWN READJUSTMENT

If the setting indicated in Step 2 of Hold-Down Operation Confirmation cannot be met, readjustment should be performed by altering the resistance value of R564 component marked with .

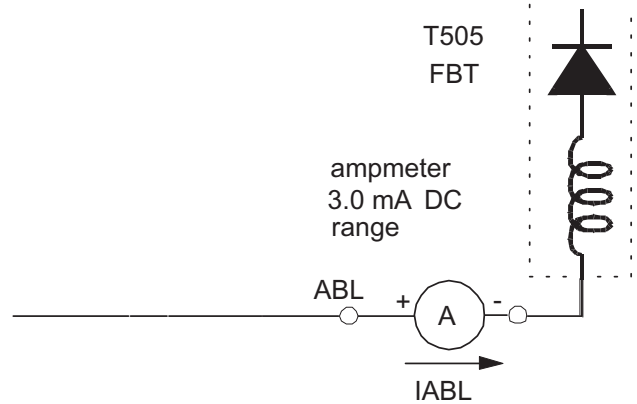

3-2. B+ VOLTAGE CONFIRMATION AND ADJUSTMENT

Note: The following adjustments should always be performed when replacing the following components, which are marked with  on the schematic diagram on the A Board:

A BOARD:	IC601, PH601
-----------------	--------------

- Using a Variac, apply AC input voltage: $130 + 2.0/ -0.0$ VAC
- Input a monoscope pattern.
- Set the PICTURE and the BRIGHTNESS controls to minimum.
- Confirm the voltage of A Board TP-600 is <136.5 VDC.
- If step 4 is not satisfied, replace the components listed above, then repeat Steps 1 – 3.

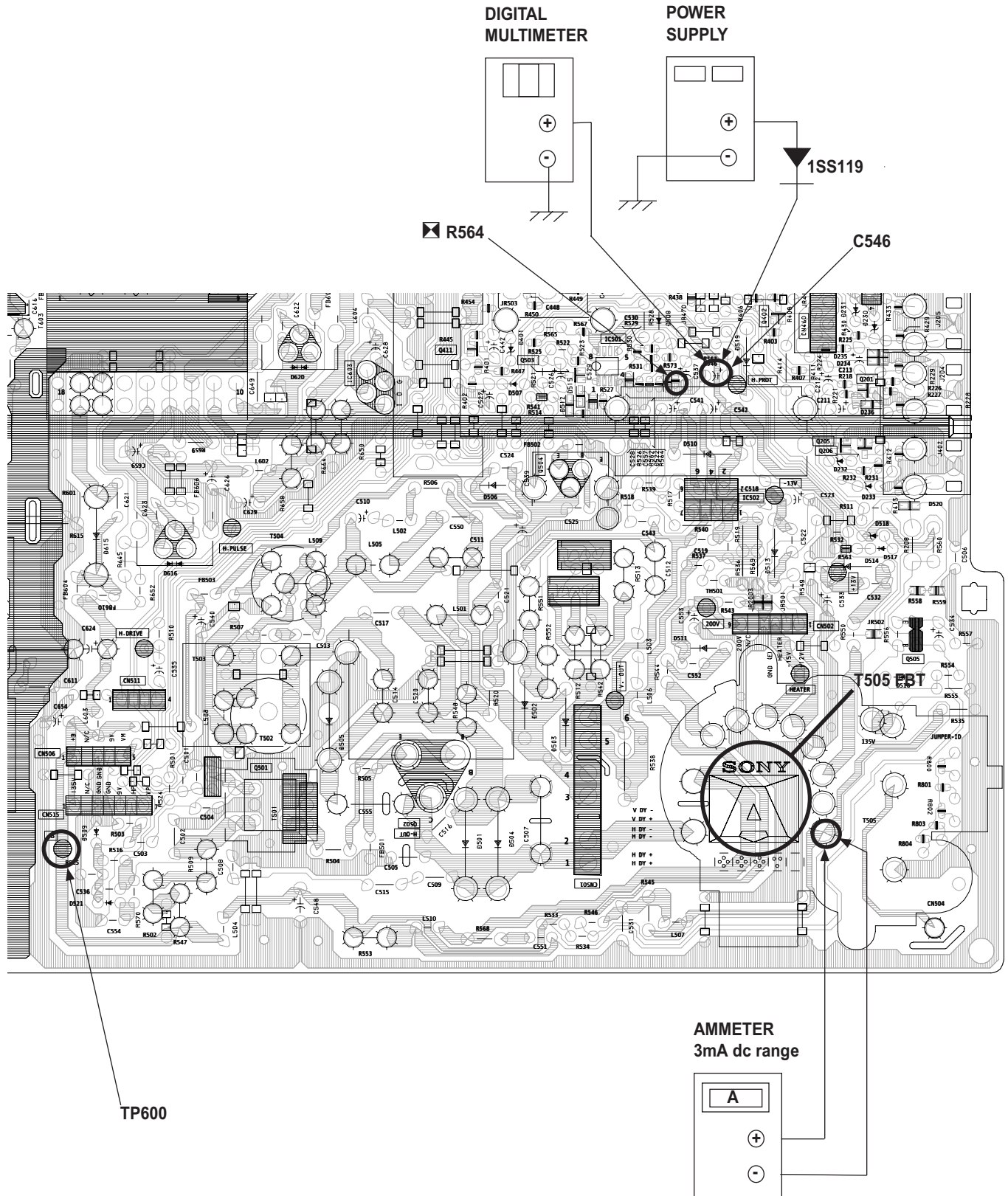

Figure 1

SECTION 4: CIRCUIT ADJUSTMENTS

ELECTRICAL ADJUSTMENTS BY REMOTE COMMANDER

Use the Remote Commander (RM-Y180, RM-Y181) to perform the circuit adjustments in this section.

Test Equipment Required: 1. Pattern generator 2. Frequency counter 3. Digital multimeter 4. Audio oscillator

4-1. SETTING THE SERVICE ADJUSTMENT MODE

- Standby mode (Power off).
- Press the following buttons on the remote commander within a second of each other:

[Display] → Channel [5] → Sound Volume [+] → Power

SERVICE ADJUSTMENT MODE ON

- The CRT displays the item being adjusted.

	Mode	Category	Display Item	Item Data
	service	defl	hsiz	16
Signal Type	ntsc			
	vchp	00000000	00000000	

- Press [1] or [4] on the Remote Commander to select the item.
- Press [3] or [6] on the Remote Commander to change the data.
- Press [MUTING] then [ENTER] to write into memory.

SERVICE ADJUSTMENT MODE MEMORY

	Mode	Category	Display Item	Item Data
	service	defl	hsiz	16
Signal Type	ntsc			write
	vchp	00000000	00000000	

[MUTING] Green

[ENTER] Red

- Press [8] then [ENTER] on the Remote Commander to initialize.

	Mode	Category	Display Item	Item Data
	service	defl	hsiz	16
Signal Type	ntsc			write
	vchp	00000000	00000000	

[MUTING] Green

[ENTER] Red

Carry out Step 1 when adjusting IDs 0-6 and when replacing and adjusting IC003

- Turn set off then on to exit service adjustment mode.

4-2. MEMORY WRITE CONFIRMATION METHOD

- After adjustment, pull out the plug from the AC outlet, then replace the plug in the AC outlet again.
- Turn the power switch ON and set to Service Mode.
- Call the adjusted items again to confirm they were adjusted.

4-3. REMOTE ADJUSTMENT BUTTONS AND INDICATORS

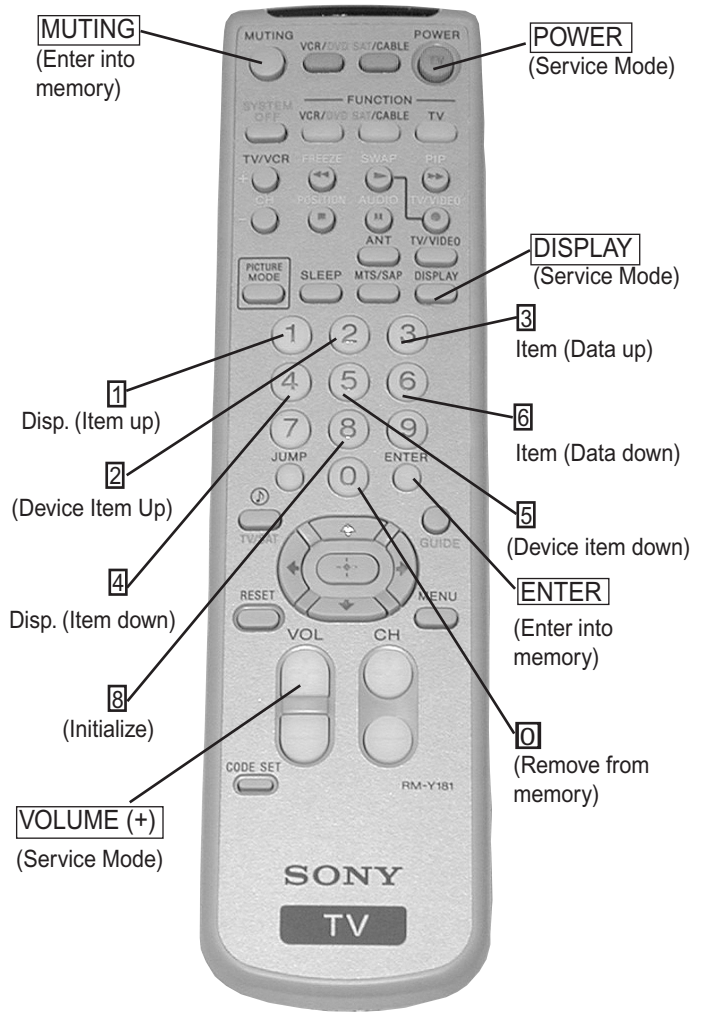

RM-Y181

ADJUSTMENT ITEMS (1 OF 4)

Reg #	ITEM	FUNCTION	RANGE	FIX DATA	NTSC 27	VIDEO	NTSC 32	RF	AVERAGE DATA 27	AVERAGE DATA 32
1	HSIZ	Horizontal Size Adjustment	0-63		0		18		11	22
2	HPOS	Horizontal Position Adjustment	0-63		13		13		20	22
3	VBOW	Vertical Line Bowing Adj.	0-15		9		9		7	9
4	VANG	Vertical Line Bowing Slant Adj.	0-15		8		3		9	7
5	VTRP	TRAPEZIUM	0-31		19		18		21	17
6	HTRP	Horiz. Trapezoid	0-15		6		6		0	2
7	TROT	Tilt Correction	0-63		31		31		31	31
8	PAMP	Horizontal PIN distortion Adj.	0-63		19		27		20	27
9	UPIN	Upper PIN Distortion Adj.	0-63		34		41		37	38
10	LPIN	Lower PIN Distortion Adj.	0-63		32		39		33	35
11	VSIZ	Vertical Size Adjustment	0-63		32		51		33	51
12	VPOS	Vertical Position Adj.	0-63		30		42		36	39
13	VLIN	Vertical Lineality Adj.	0-15		3		5		3	4
14	SCOR	Vertical "S" Correction Adjustment	0-15		6		8		8	8
15	VZOM	16:9 CRT Z Mode on/off	0-1	0					0	0
16	EHT	Vertical High-Voltage Compensation	0-15	5					5	5
17	ASP	Aspect Ratio Control	0-63	47					47	47
18	SCRL	16:9 CRT Z Mode Trans. Scroll	0-63	31					31	31
19	HBLK	Horizontal Blanking on/off	0-1	1					1	1
20	LBLK	Left Blanking Adjustment	0-15	****					13	13
21	RBLK	Righth Blanking Adjustment	0-15	*****					7	8
22	HDW	Horizontal Drive Pulse Width	0-1	1					1	1
23	EWDC	"Parabola" EW, D.C. Adjustment	0-1	0					0	0
24	LVLN	Lower Screen BTM Vertical Line Adj.	0-15	0					0	0
25	UVLN	Upper Screen BTM Vertical Line Adj.	0-15	0					0	0
26	INTL	INTERLACE	0-3	0					0	0
27	G2SW		0-1	0					0	0
28	G2LV		0-7	0					0	0
29	HOSC	Horizontal VCO Oscillation Freq.	0-15	12					7	7
30	VSS	Vertical Sync Slice Level	0-3	0					0	0
31	HSS	Horizontal Sync Slice Level	0-1	0					0	0
32	HMSK	For Macro Vision	0-1	0					0	0
33	VTMS	Select Signal VTIM Pin	0-3	0					0	0
34	CDMD	Vertical Count Down Mode Switching	0-3			3		*	3	3
35	AFC	AFC Loop Gain Switching	0-3	0					0	0
36	FIFR	Field Frequency	0-3	3					3	3
37	VBLK	VBLKW	0-3	0					0	0
38	REFP	REFP	0-1	0					0	0
39	JPSW	JUMPSW	0-1	MENU					0	0
40	RDRV	R Output Drive control	0-63	***					31	40
41	GDRV	G Output Drive control	0-63	25					22	42
42	BDRV	B Output Drive control	0-63	25					21	31
43	RCUT	R Output Cutoff control	0-63	31					31	31
44	GCUT	G Output Cutoff control	0-63	15					13	12
45	BCUT	B Output Cutoff control	0-63	12					14	15
46	SCON	SUB CONT	0-15	8					11	11
47	SHUE	Sub HUE adjustment	0-15	16					17	16
48	SCOL	Sub COLOR adjustment	0-15		18				17	18
49	SBRT	Sub BRIGHTNESS adjustment	0-31	16					15	16
50	CHUE	SUB COLOR (RF)	0-31	7					6	6
51	CCOL	SUB COLOR (RF)	0-31		7				7	4
52	UOFS	YUV U OFFSET	0-15	7					7	7
53	VOFS	YUV V OFFSET	0-15	7					7	7
54	RON	R Output on/off	0-1	1					1	1

* CDMD = 3 for US & CND, CDMD = 0 for Other

*** RDRV = 41 for 27FS/32FS families, 31 for 27FV family

****LBLK = 0 for 27FV/29FV/32FS/34FS family, 5 FOR 27FS family

***** RBLK = 3 for 27FV/29FV/32FS/34FS family, 2 for 27FS family

ADJUSTMENT ITEMS (2 OF 4)

Reg #	ITEM	FUNCTION	RANGE	FIX DATA	NTSC 27	VIDEO	NTSC 32	RF	AVERAGE DATA 27	AVERAGE DATA 32
55	GON	G Output on/off	0-1	1					1	1
56	BON	B Output on/off	0-1	1					1	1
57	AXPL	Axis PAL	0-1	0					0	0
58	AXNT	Axis NTSC	0-1	1					1	1
59	CBPF	Chroma BPF on/off	0-1	1					1	1
60	CTRP	Y TRAP FILTER on/off	0-1	1					1	1
61	COFF	Color On/off	0-1	0					0	0
62	KOFF	Set Color Killer	0-1	0					0	0
63	SSHP	Sub SHARPNESS	0-15	5					5	5
64	SHPF	SHARPNESS Circuit Fo	0-3	Palette Mode Controls This Register					2	2
65	PREL	Pre-Shoot/ Over-Shoot	0-1	1					0	0
66	Y-DC	DC transmission Ratio Switching	0-3	Palette Mode Controls This Register					2	2
67	GAMM	Gamma Correction	0-3	Palette Mode Controls This Register					2	2
68	ABLM	ABL Mode Switch	0-1	1					1	1
69	VTH	ABL CD VHT Switching	0-1	1					1	1
70	YDEL	Y Delay Time Control	0-15	7					7	7
71	NCOL	No Color ID	0-1	1					1	1
72	FSC	FSC Out on/off	0-1	1					1	1
73	K-ID	Killer ID Control on/off	0-1	0					0	0
74	GDOF		0-31	3					3	3
75	BDOF		0-31	16					16	16
76	GCOF		0-31	16					16	16
77	BCOF		0-31	7					7	7
78	SYSC	Color System	0-7	4					4	4
79	VENH	Vertical Enhancement	0-7	Palette Mode Controls This Register					5	3
80	PDSO	PDS OFF	0-1	0					0	0
81	CK	CK	0-1	0					0	0
82	VNL	VNL	0-15	3					3	3
83	HPK	HPK	0-1	0					0	0
84	HPKO	HPK OFF	0-1	Palette Mode Controls This Register					0	0
85	CORE	CORE	0-3	2					1	1
86	TRAP	TRAP	0-1	1					1	1
87	CHTR	CH TRAP	0-1	0					0	0
88	CBPF	CBPF	0-1	1					1	1
89	ENHO	ENH OFF	0-1	0					0	0
90	NMRD	NMRD	0-3	0					0	0
91	YAPS	YAPS	0-3	3					3	3
92	CLKS	CLKS	0-3	0					0	0
93	NSTD	NSTDS	0-3	0					0	0
94	MSS	MSS	0-3	0					0	0
95	KILS	KILS	0-3	1					1	1
96	ADIN	ADIN	0-1	0					0	0
97	EXCS	EXCSS	0-3	1					1	1
98	CPP	CPP	0-3	2					2	2
99	HDP	HDP	0-7	4					4	4
100	CDL	CDL	0-7	4					4	4
101	DYCR	DYCOR	0-15	2					2	2
102	DYGN	DYGAIN	0-15	10					10	10
103	DCCR	DCCOR	0-15	3					3	3
104	DCGN	DCGAIN	0-15	6					6	6
105	YNRL	YNRLIM	0-3	1					1	1
106	CNRL	CNRLIM	0-3	1					1	1
107	WSC	WSC	0-3	1					1	1
108	VTRH	VTRH	0-3	1					1	1

ADJUSTMENT ITEMS (3 OF 4)

Reg #	ITEM	FUNCTION	RANGE	FIX DATA	NTSC 27	VIDEO	NTSC 32	RF	AVERAGE DATA 27	AVERAGE DATA 32
109	VTRR	VTRR	0-3	1					1	1
110	LDSR	LDSR	0-3	2					2	2
111	VAPG	VAPGAIN	0-7	3					3	3
112	VAPI	VAPINV	0-31	6					6	6
113	TEST	TEST	0-1	0					0	0
114	YPFT	YPFT	0-3	3					3	3
115	YPFG	YPFG	0-15	7					7	7
116	CC3N	CC3N	0-1	0					0	0
117	SELD		0-1	1					1	1
118	D2GN	D2GAIN	0-7	4					5	5
119	YHCR	YHCOR	0-3	0					0	0
120	YPFC	YPFCOR	0-1	0					0	0
121	SHT	SHT	0-3	0					0	0
122	MVT	MVT	0-1	0					0	0
123	OTT	OTT	0-1	0					0	0
124	CL2D	CL2D	0-1	1					1	1
125	CLKG	CLKGGT	0-1	0					0	0
126	HPLL	HPLLFS	0-1	1					1	1
127	BPLL	BPLLFS	0-1	0					0	0
128	FSCF	FSCFG	0-1	0					0	0
129	PLLS	PLLS	0-1	1					1	1
130	KILR	KILR	0-15	3					3	3
131	HSSL	HSSL	0-15	12					12	12
132	VSSL	VSSL	0-15	8					8	8
133	BGPS	BGPS	0-15	4					4	4
134	BGPW	BGPW	0-15	10					10	10
135	ADCK	ADCLKS	0-3	3					3	3
136	NDSW	NSDSW	0-1	1					1	1
137	PFRN	FREE_RUN	0-1	0					0	0
138	PRVS	RVS	0-1	0					0	0
139	PCON	CONTRAST	0-127	97					45	45
140	PUCO	U-DAC	0-127	5					16	16
141	PVCO	V-DAC	0-127	5					24	24
142	PHUE		0-31	12					15	15
143	PKIL	KILLER	1	0					0	0
144	PSEP	EXT_SC_SEL	0-3	1					2	2
145	PHIM		0-1	0					0	0
146	PSUB		0-1	0					0	0
147	PBGS	BG_START	0-63	14					14	14
148	PDL0		0-15	10					6	6
149	PDL1		0-15	13					13	13
150	PBRT	Y_OFFSET	0-31	25					25	25
151	PVP1			0					0	0
152	PUP1			0					0	0
153	PVP2			0					0	0
154	PUP2			0					0	0
155	PVP3			0					0	0
156	PUP3			0					0	0
157	PACS	SET_ACC	0-1	1					1	1
158	PSDL	YUV_Color (More Significant)	0-3	2					0	0
159	PDCO	YUV_Color (Less Significant)	0-3	2					0	0

ADJUSTMENT ITEMS (4 OF 4)

Reg #	ITEM	FUNCTION	RANGE	FIX DATA	NTSC 27	VIDEO	NTSC 32	RF	AVERAGE DATA 27	AVERAGE DATA 32
160	PCGA	C_GAIN	0-1	1					1	1
161	PAAF		0-1	0					0	0
162	PSU2		0-1	0					0	0
163	PCVF		0-1	0					0	0
164	PBIT	BITSEL	0-1	0					0	0
165	PAFC	AFCBITSEL	0-1	0					0	0
166	PACC	ACC_LEVEL	0-63	21					22	22
167	PBUR	BURST_CLK	0-1	0					0	0
168	PEVE	EVENUPRA	0-1	0					0	0
169	PINW	INV_WFF	0-1	0					0	0
170	PINR	INV_REF	0-1	0					0	0
171	PREF	RFF_FIX	0-1	0					0	0
172	PARE	AUTO_REF	0-1	1					1	1
173	PAVE	AVERAGE	0-1	0					0	0
174	PFRA	FREE_RUN_ADJ	0-15	0					0	0
175	PPAL	SUB_PALM_JUDGE	0-255	0					0	0
176	PHPO		0-31	9					7	6
177	PVPO		0-31	22					22	22
178	PHTI	HT	0-15	5					9	9
179	PHAJ	ADJ	0-15	1					1	1
180	PBGY	BGY	0-15	0					0	0
181	PCRO	CROSS_SEL	0-1	0					0	0
182	PPAR	PALRY	0-63	2					2	2
183	PHPF	HPFOFF	0-1	0					0	0
184	PFSC	FSC_OUTPUT	0-1	0					0	0
185	PVCH	SET_VCHIP	0-1	0					0	0
186	PVON	VCHIP_ONLY	0-1	1					1	1
187	PVLN	LINE_NUM	0-31	17					17	17
188	PVSB	STB_DLY	0-255	64					64	64
189	PVLV	L_LEVEL	0-255	130					130	130
190	SBAL	Sub Balance	0-7	5					5	5
191	SBAS	Sub Bass	0-7		****				0	0
192	STRE	Sub Treble	0-7		*****				3	3
193	BBEL	BBE Low	0-15	*****					0	0
194	BBEH	BBE High	0-15	*****					0	0
195	BBE	BBE	0-1	*****					0	0
196	AUX	SRS, Simulated	0-3	0					0	0
197	DISP	O.S.D Display position	0-127	20					32	34
198	HCLW	Horizontal Count Lower limit	0-255	16		16			16	16
199	HCHG	Horizontal Count High limit	0-255	64		64			64	64
200	ID0		0-255	25					See ID Map	
201	ID1		0-255	3					See ID Map	
202	ID2		0-255	91					See ID Map	
203	ID3		0-255	2					See ID Map	
204	ID4		0-255	233					See ID Map	
205	ID5		0-255	17					See ID Map	
206	ID6		0-255	0					See ID Map	

****SBAS = 0 for 27FV/29FV/32FS/34FS family, 5 for 27FS family

***** STRE = 3 for 27FV/29FV/32FS/34FS family, 2 for 27FS family

***** BBEL = 5 for 27FV family; 6 for 29FV family and 0 for 27FS/29FS/32FS family

***** BBEH = 5 for 27FV family; 7 for 29FV family and 0 for 27FS/29FS/32FS family

***** BBE = 1 for 27FV/29FV families and 0 for 27FS/29FS/32FS family

Notes:

No. 1-206 show the order that each adjustment mode may be selected while in Service Mode.

Data Range shows the range of possible settings for each Adjustment Mode.

Initial Data shows the standard settings for each Adjustment Mode.

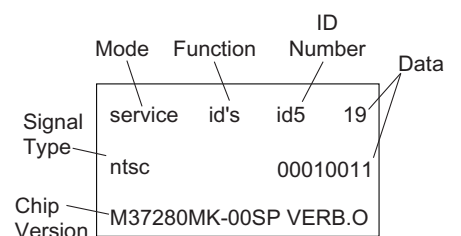

FEATURE ID MAP

Model	Destination	ID-0	ID-1	ID-2	ID-3	ID-4	ID-5	ID-6
KV-27FS13	US	89	31	79	146	137	19	0
KV-27FS13	CND	89	31	79	178	137	19	0
KV-27FS17	US	89	31	79	146	137	19	7
KV-27FV17	US	89	63	239	146	133	19	7
KV-27FV17	CND	89	63	239	178	133	19	7
KV-29FV17	E	17	63	255	130	229	19	7
KV-29FV17C	E	17	63	255	130	229	19	7
KV-32FS13	US	89	31	79	146	137	19	0
KV-32FS13	CND	89	31	79	178	137	19	0
KV-32FS17	US	89	31	79	146	137	19	7
KV-34FS13C	E	17	31	223	130	233	19	0
KV-34FS17	E	17	31	223	130	233	19	7

4-4. MA BOARD ADJUSTMENTS

H. FREQUENCY (FREE RUN) CHECK

1. Input a TV mode (RF) with no signal.
2. Connect a frequency counter to base of Q501 (TP-500 H. DRIVE) on the A Board.
3. Check H. Frequency for 15735 ± 200 Hz.

V. FREQUENCY (FREE RUN) CHECK

1. Select video 1 with no signal input.
2. Set the conditions for a standard setting.
3. Connect the frequency counter to TP-508 (V OUT) or CN501 pin ⑥ (V DY+) and ground on the A Board.
4. Check that V. Frequency shows 60 ± 4 Hz.

DRIVE (RDRV)

1. Input a color-bar signal and set the level to 75%.
2. Set in Standard Mode.
3. Activate the Service Adjustment Mode.
4. Set both GON and BON items. Using **3** and **6** set each to the following values. Leave RON set to "1".

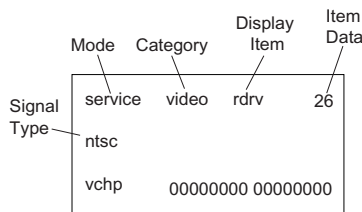

R ON: ON (1)
G ON: OFF (0)
B ON: OFF (0)

5. Connect an oscilloscope probe to CB Board, J701 Pin 12 (KR) (Red Out).
6. Select RDRV with **1** and **4**.
7. Adjust the value of RDRV with **3** and **6** for 92.5 ± 3 VDC.

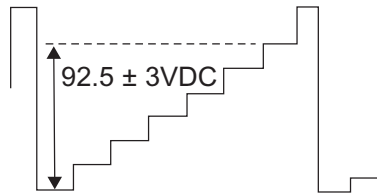

8. Reset GON and BON values to "1".
R ON: ON (1)
G ON: ON (1)
B ON: ON (1)
9. Press **MUTING** then **ENTER** to save into the memory.

Display Position Adjustment (DISP)

1. Input a color-bar signal.
2. Set to Service Adjustment Mode.
3. Select DISP with **1** and **4**.
4. Adjust values of DISP with **3** and **6** to adjust characters to the center.
5. Write to memory by pressing **MUTING** then **ENTER**.
6. Check to see if the text is displayed on the screen.

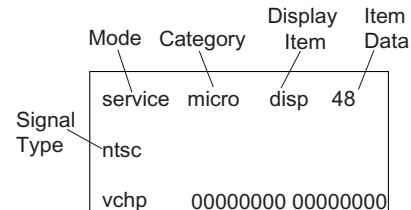

SUB BRIGHT ADJUSTMENT (SBRT)

1. Input a monoscope signal.
2. Activate the Service Adjustment Mode.
3. Set the PICTURE and BRIGHTNESS to minimum.
4. Select the SBRT item with **1** and **4**.
5. Adjust the values of SBRT with **3** and **6** to obtain a faintly visible crosshatch.
6. Press **MUTING** then **ENTER** to save into the memory.

SUB HUE, SUB COLOR ADJUSTMENT (SHUE, SCOL)

1. Input a color-bar signal.
2. Activate the Service Adjustment Mode.
3. Connect an oscilloscope probe to CB Board, CN705 Pin ④ Blue Out.
4. Select the SHUE and SCOL item with **1** and **4**.
5. While showing the SHUE item, adjust the waveform with **1** and **4** until the second and third bars show the same level ($V2 = V3 < 0.1$ Vp-p).
6. While showing the SCOL item, adjust the waveform with **3** and **6** until the first and fourth bars show the same level ($V1 = V4 < 0.1$ Vp-p).

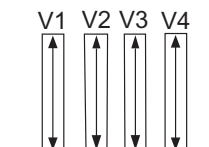

7. Press **MUTING** then **ENTER** to save into the memory.

V. SIZE ADJUSTMENT (VSIZ)

1. Input a crosshatch signal.
2. Activate the Service Adjustment Mode.
3. Select the VSIZ item with **1** and **4**.
4. Adjust value of VPOS with **1** and **4** for the best vertical center.
5. Press **MUTING** then **ENTER** to save into the memory.

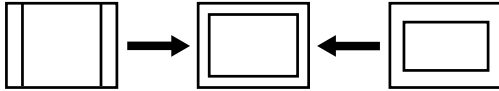

V. CENTER ADJUSTMENT (VPOS)

Perform this adjustment after performing H. Frequency (Free Run) Check.

1. Input a crosshatch signal.
2. Activate the Service Adjustment Mode.
3. Select the VPOS item with **1** and **4**.
4. Adjust value of VPOS with **3** and **6** for the best vertical center.
5. Press **MUTING** then **ENTER** to save into the memory.

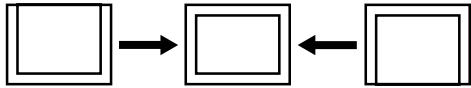

H. CENTER ADJUSTMENT (HPOS)

Perform this adjustment after performing H. Frequency (Free Run) Check.

1. Input a crosshatch signal.
2. Activate the Service Adjustment Mode.
3. Select the HPOS item with **1** and **4**.
4. Adjust the value of HPOS with **3** and **6** for the best horizontal center.
5. Press **MUTING** then **ENTER** to save into the memory.

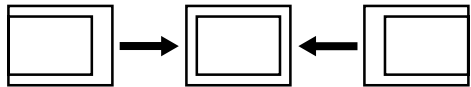

H. SIZE ADJUSTMENT (HSIZ)

1. Input a monoscope signal.
2. Activate the Service Adjustment Mode.
3. Select HSIZ with **1** and **4**.
4. Adjust with **3** and **6** for the best horizontal size.
5. Press **MUTING** then **ENTER** to save into the memory.

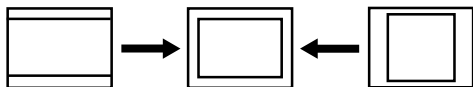

V. LINEARITY (VLIN), V. CORRECTION (SCOR), PIN AMP (PAMP), AND HORIZONTAL TRAPEZOID (HTRP) ADJUSTMENTS

1. Input a crosshatch signal.
2. Activate the Service Adjustment Mode.
3. Select VLIN, SCOR, PAMP, and HTRP with with **1** and **4**.

4. Adjust with **3** and **6** for the best horizontal size.
5. Press **MUTING** then **ENTER** to save into the memory.

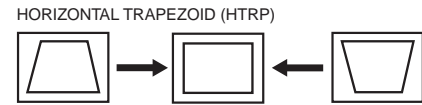
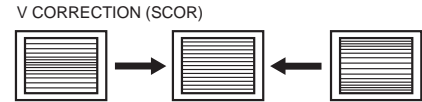
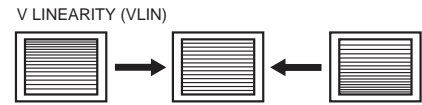

V. ANGLE (VANG), V. BOW (VBOW), UPPER PIN (UPIN) AND LOW PIN (LPIN) ADJUSTMENTS

1. Input a crosshatch signal.
2. Activate the Service Adjustment Mode.
3. Select VANG, VBOW, UPIN, and LPIN with **1** and **4**.
4. Adjust with **3** and **6** for the best picture.
5. Press **MUTING** then **ENTER** to save into the memory.

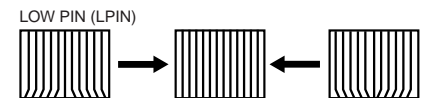
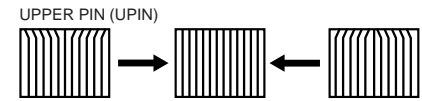
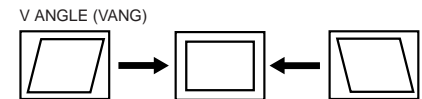

SERVICE ADJUSTMENT MODE MEMORY

1. After completing all adjustments, press **0** then **ENTER**.
Read From Memory

Mode	Category	Display Item	Item Data	
service	defl	vbow	7	Green
ntsc				0
vchp	00000000	00000000		Red
				ENTER

SECTION 5: DIAGRAMS

5-1. CIRCUIT BOARDS LOCATION

(KV-27FV17/29FV17/29FV17C/32FS13/32FS17/34FS13C/34FS17 ONLY)

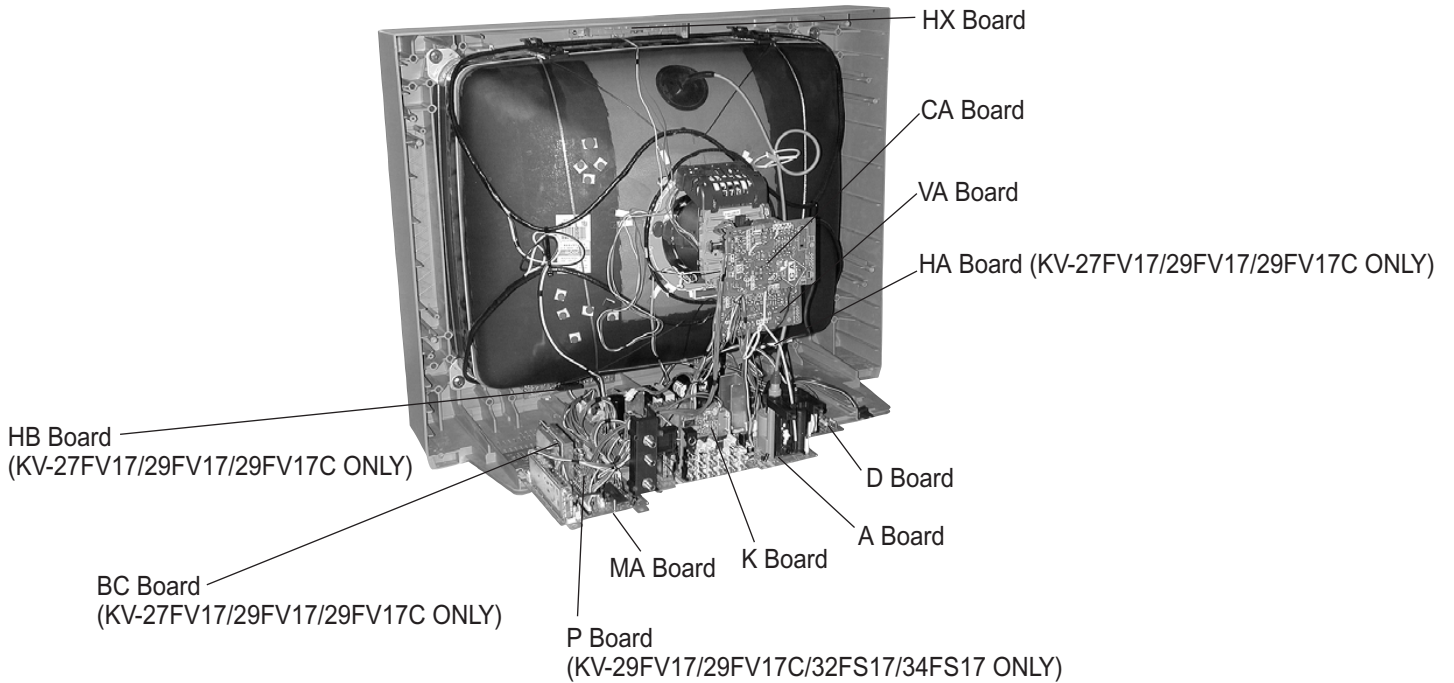

(KV-27FS13/27FS17 ONLY)

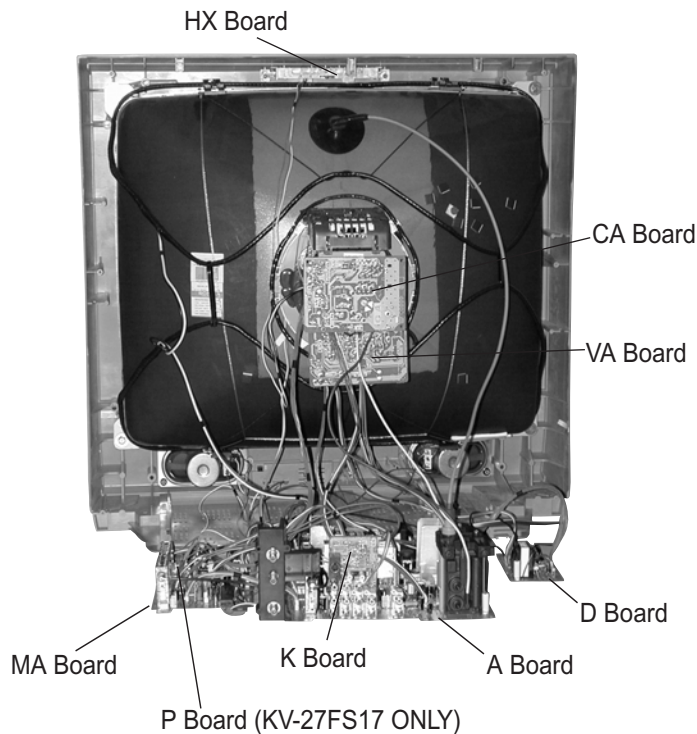

5-2. PRINTED WIRING BOARD AND SCHEMATIC DIAGRAM INFORMATION

All capacitors are in μF unless otherwise noted. pF : μF 50WV or less are not indicated except for electrolytics and tantalums.

All electrolytics are in 50V unless otherwise specified.

All resistors are in ohms. K=1000, M=1000k

Indication of resistance, which does not have one for rating electrical power, is as follows:

Pitch : 5mm

Rating electrical power : $\frac{1}{4}$ W

$\frac{1}{4}$ W in resistance, $\frac{1}{10}$ W and $\frac{1}{8}$ W in chip resistance.

 : nonflammable resistor.

 : fusible resistor.

 : internal component.

 : panel designation and adjustment for repair.

All variable and adjustable resistors have characteristic curve B, unless otherwise noted.

Readings are taken with a color-bar signal input.

Readings are taken with a 10M digital multimeter.

Voltages are DC with respect to ground unless otherwise noted.

Voltage variations may be noted due to normal production tolerances.

All voltages are in V.

S : Measurement impossibility.



 : B+line.

 : B-line. (Actual measured value may be different).



 : signal path. (RF)

Circled numbers are waveform references.

The components identified by  in this basic schematic diagram have been carefully factory-selected for each set in order to satisfy regulations regarding X-ray radiation. Should replacement be necessary, replace only with the value originally used.

When replacing components identified by , make the necessary adjustments as indicated. If the results do not meet the specified value, change the component identified by  and repeat the adjustment until the specified value is achieved. (Refer to Safety Related Adjustments on Page 14.)

When replacing the parts listed in the table below, it is important to perform the related adjustments.

Part Replaced ()	Adjustment ()
DY, T505, CRT, IC501 C507, C520, C505, C509, C515, T504, T503, C551, L510, C546, C537, C547, D517, D518, D519, R560, R561, R562, R563, R565, R566, R567, R525.....A Board	HV HOLD-DOWN R564
IC301.....MA Board	

REFERENCE INFORMATION

RESISTOR

: RN METAL FILM
 : RC SOLID
 : FPRD NONFLAMMABLE CARBON
 : FUSE NONFLAMMABLE FUSIBLE
 : RW NONFLAMMABLE WIREWOUND
 : RS NONFLAMMABLE METAL OXIDE
 : RB NONFLAMMABLE CEMENT
 :  ADJUSTMENT RESISTOR

COIL

: LF-8L MICRO INDUCTOR

CAPACITOR

: TATANTALUM
 : PS STYROL
 : PP POLYPROPYLENE
 : PT MYLAR
 : MPS METALIZED POLYESTER
 : MPP METALIZED POLYPROPYLENE
 : ALB BIPOLAR
 : ALT HIGH TEMPERATURE
 : ALR HIGH RIPPLE

The components identified by shading and  symbol are critical for safety. Replace only with part number specified.

The symbol  indicates a fast operating fuse and is displayed on the component side of the board. Replace only with fuse of the same rating as marked.

Les composants identifiés par un trame et une marque  sont critiques pour la sécurité. Ne les remplacer que par une pièce portant le numéro spécifique.

Le symbole  indique une fusible à action rapide. Doit être remplacé par une fusible de même valeur, comme marqué.

BLOCK DIAGRAM (1 OF 6) (KV-27FS13/27FS17/32FS13/32FS17/34FS13C/34FS17 ONLY)

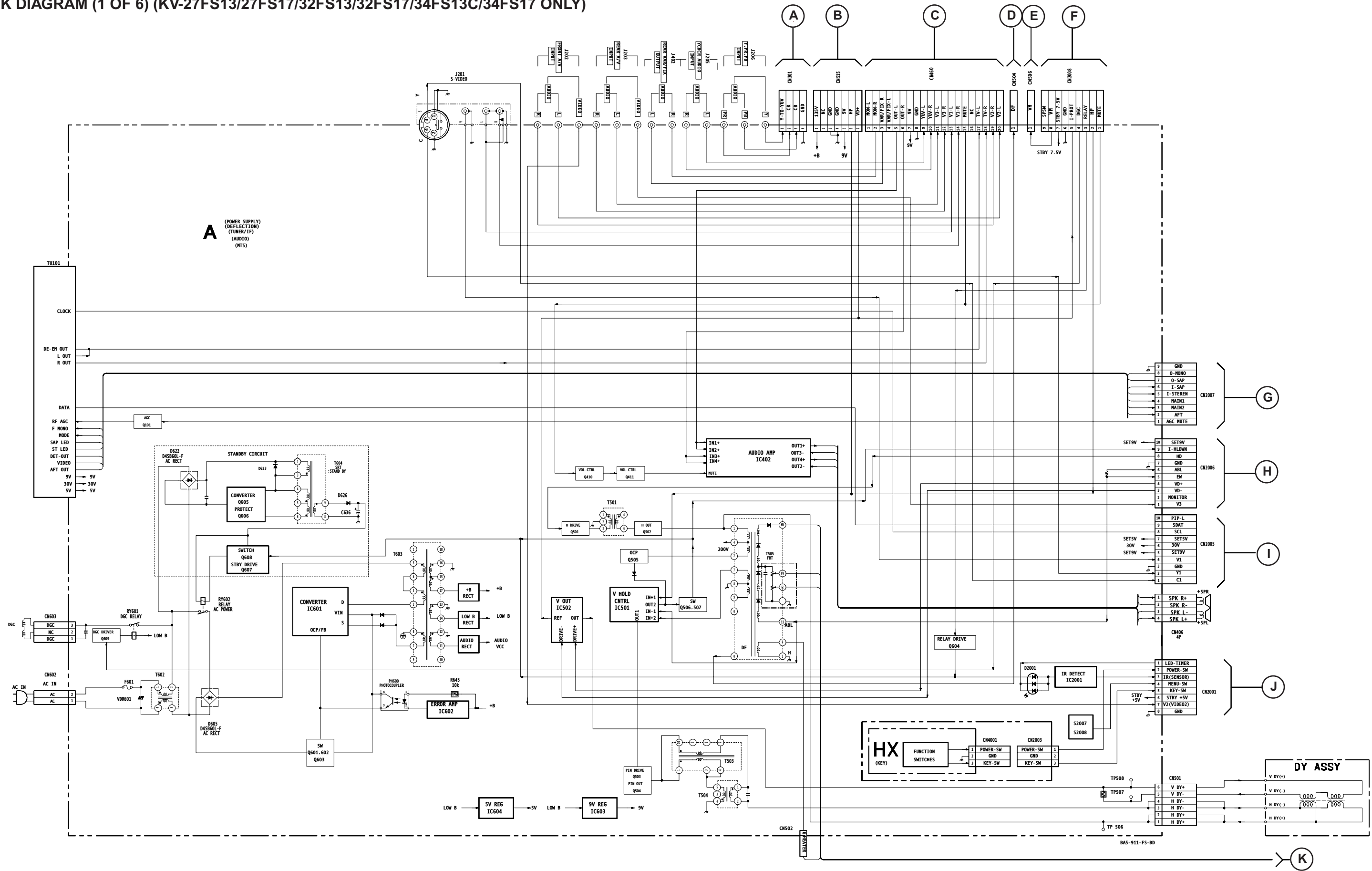

BLOCK DIAGRAM (2 OF 6) (KV-27FS13/27FS17/32FS13/32FS17/34FS13C/34FS17 ONLY)

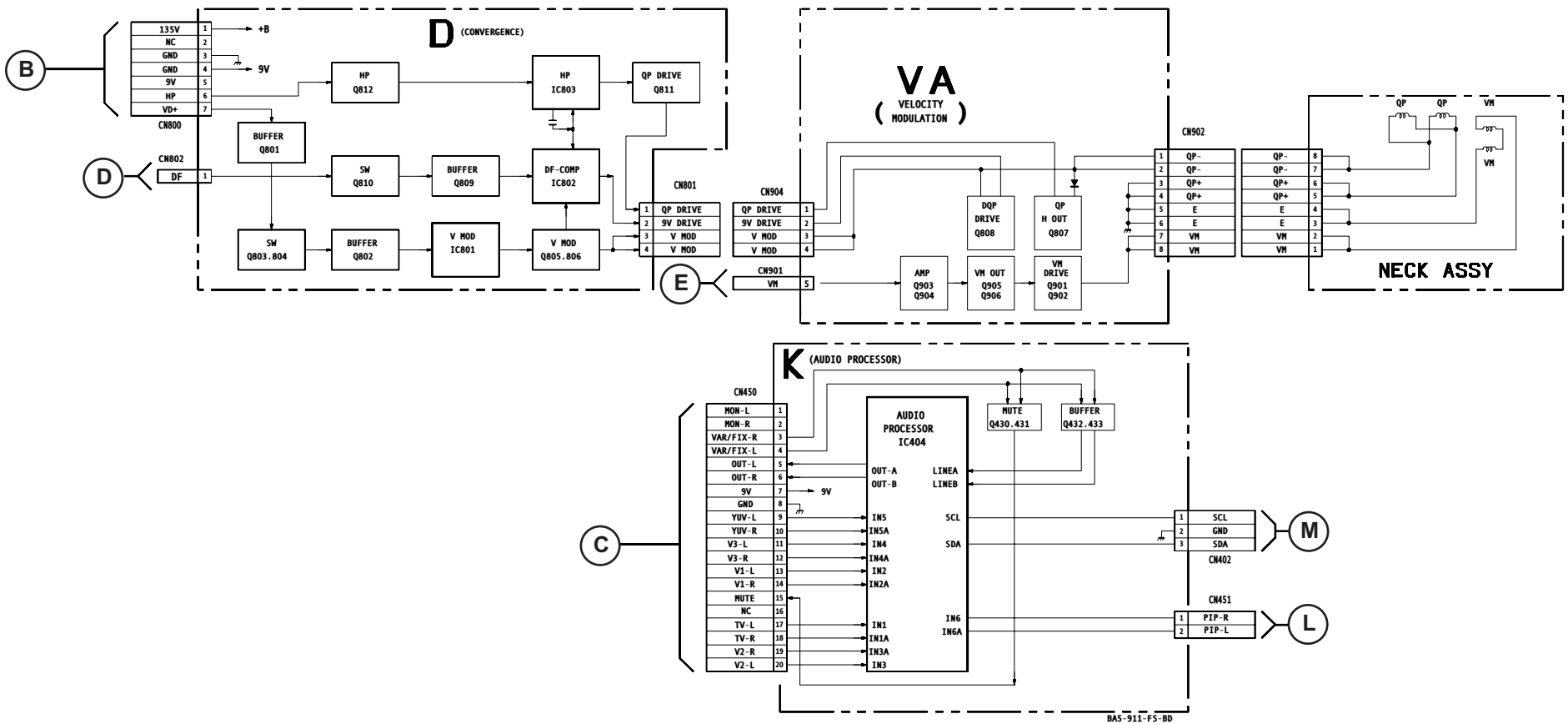

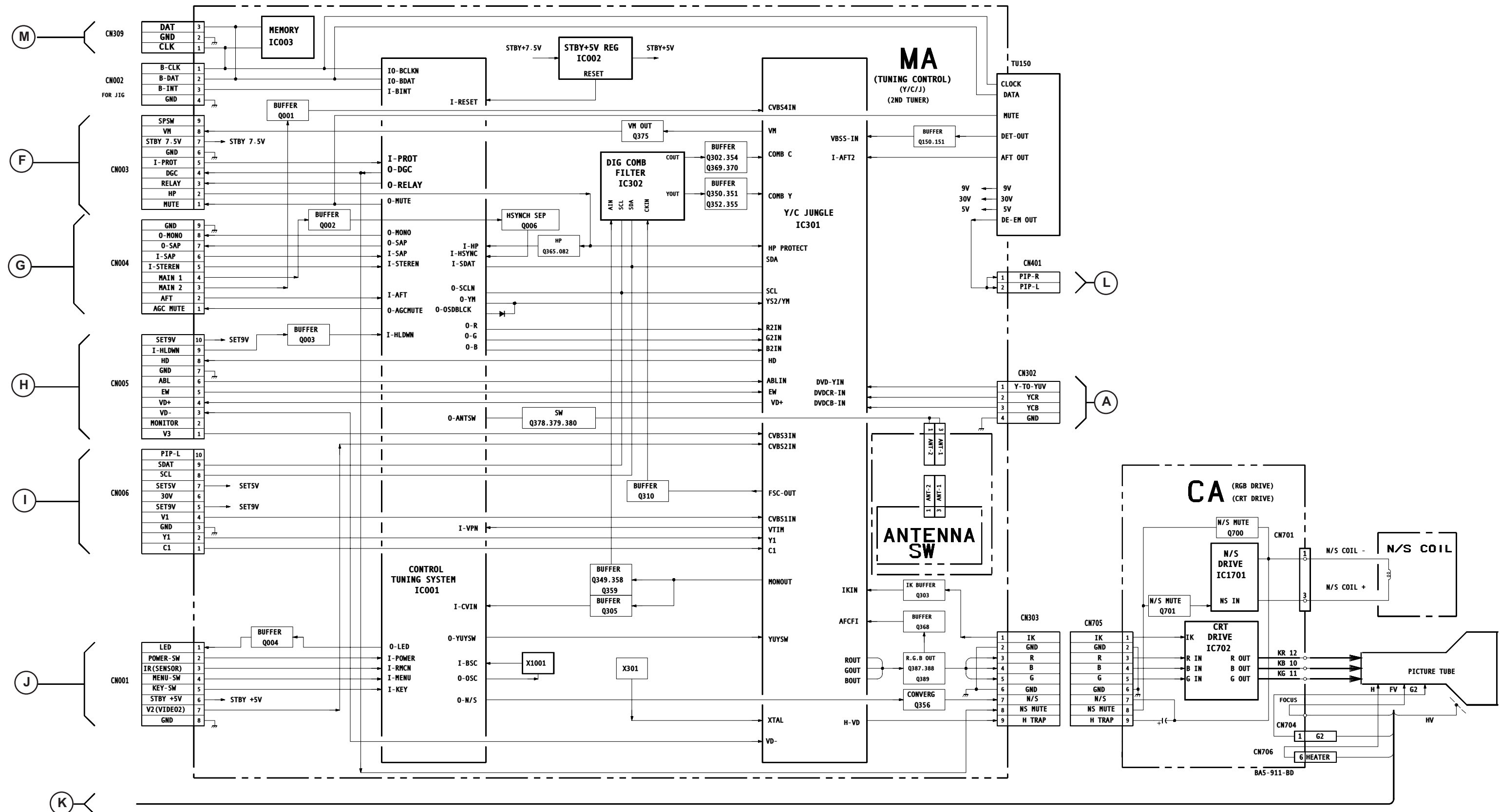

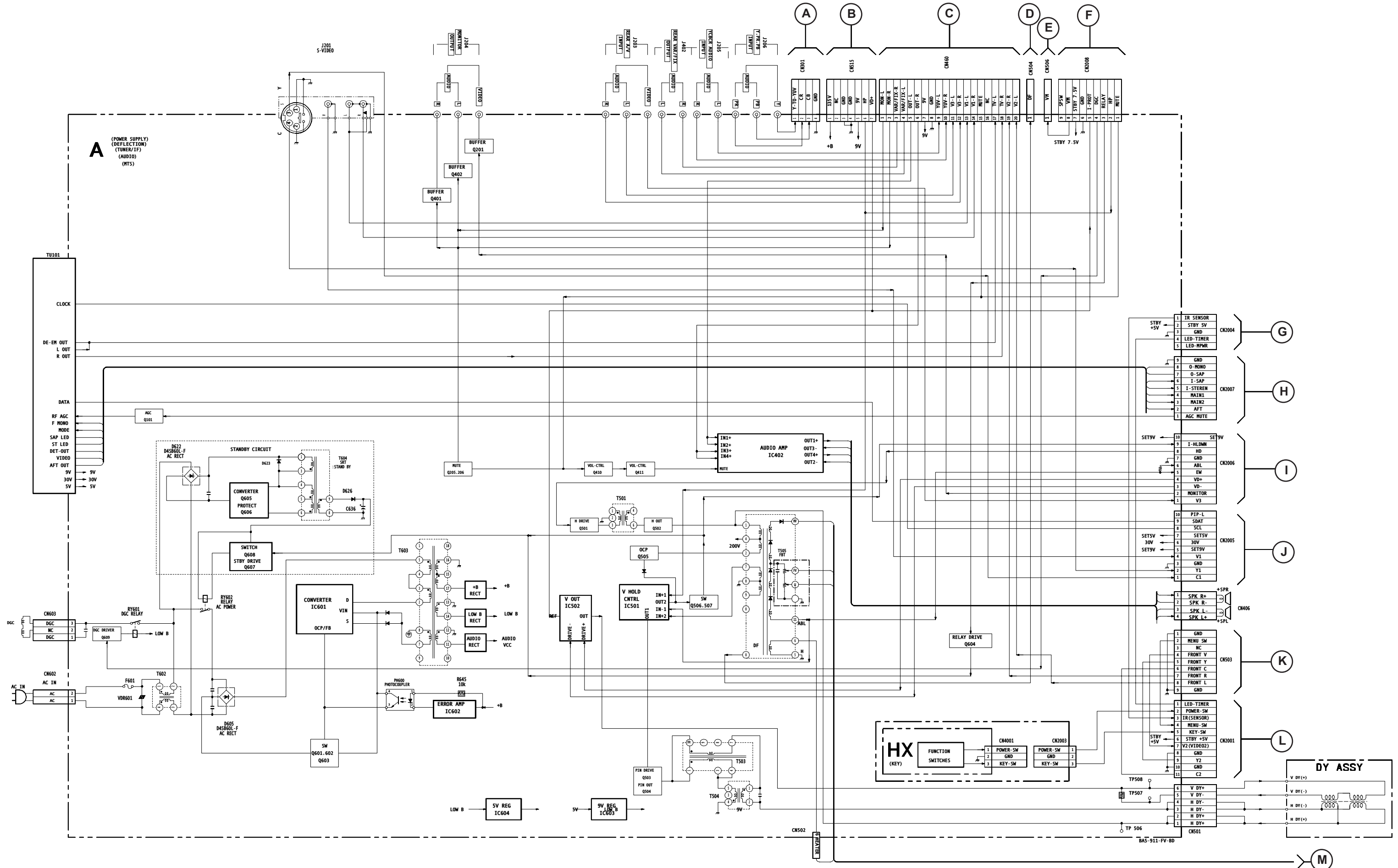

BLOCK DIAGRAM (5 OF 6) (KV-27FV17/29FV17/29FV17C ONLY)

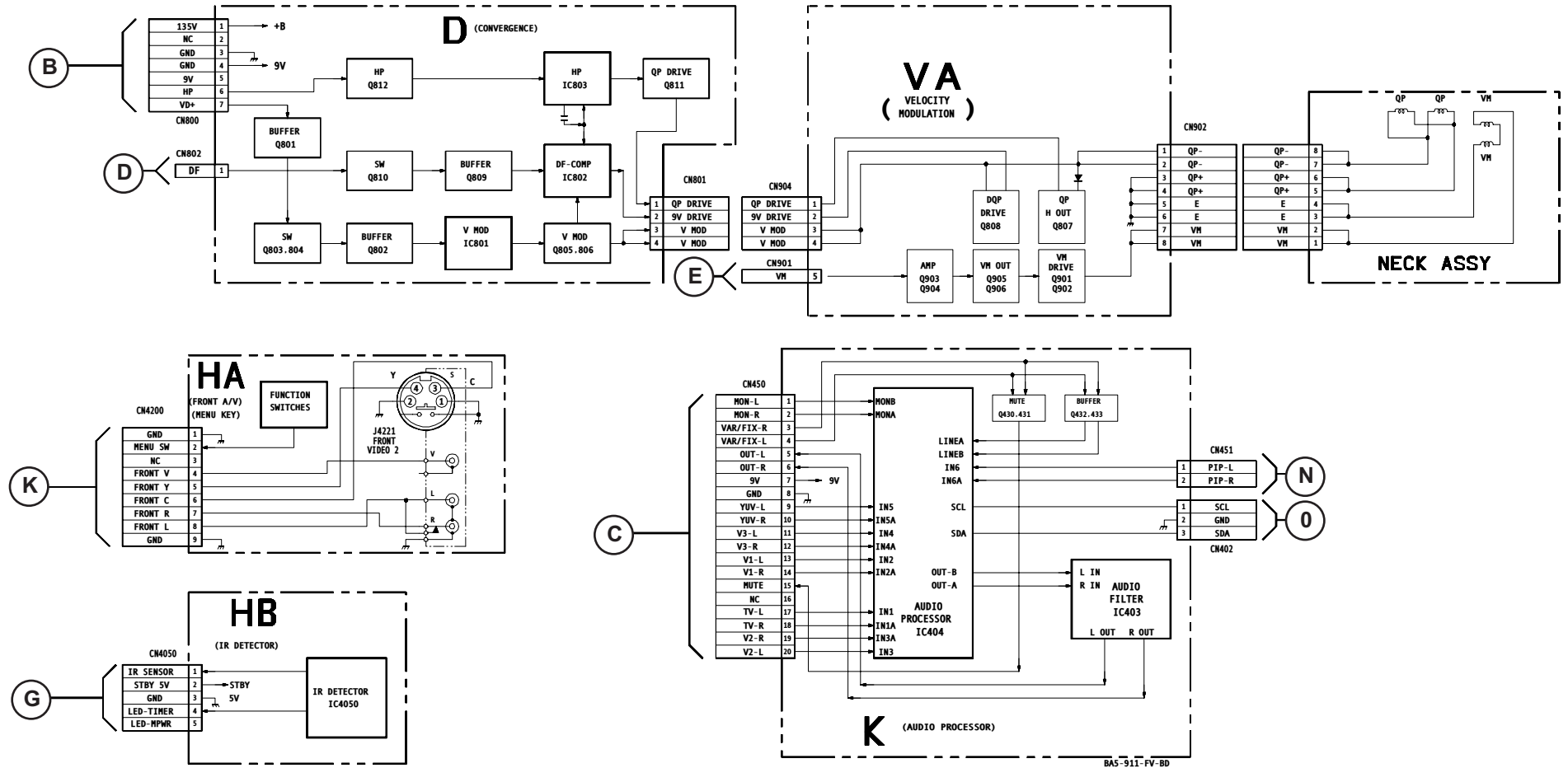

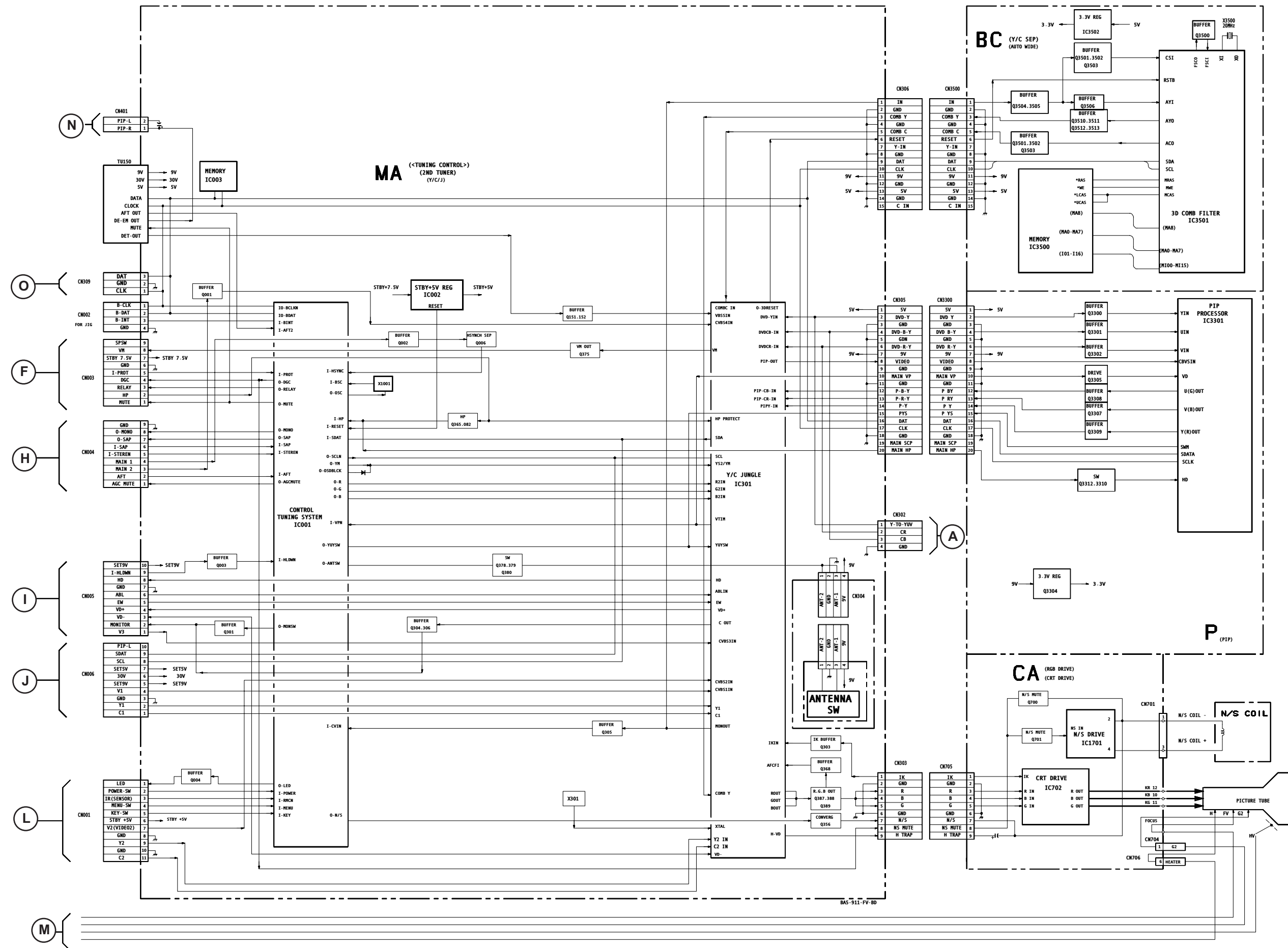

A BOARD SCHEMATIC DIAGRAM (KV-27FS13/27FS17/32FS13/32FS17/34FS13C/34FS17 ONLY)

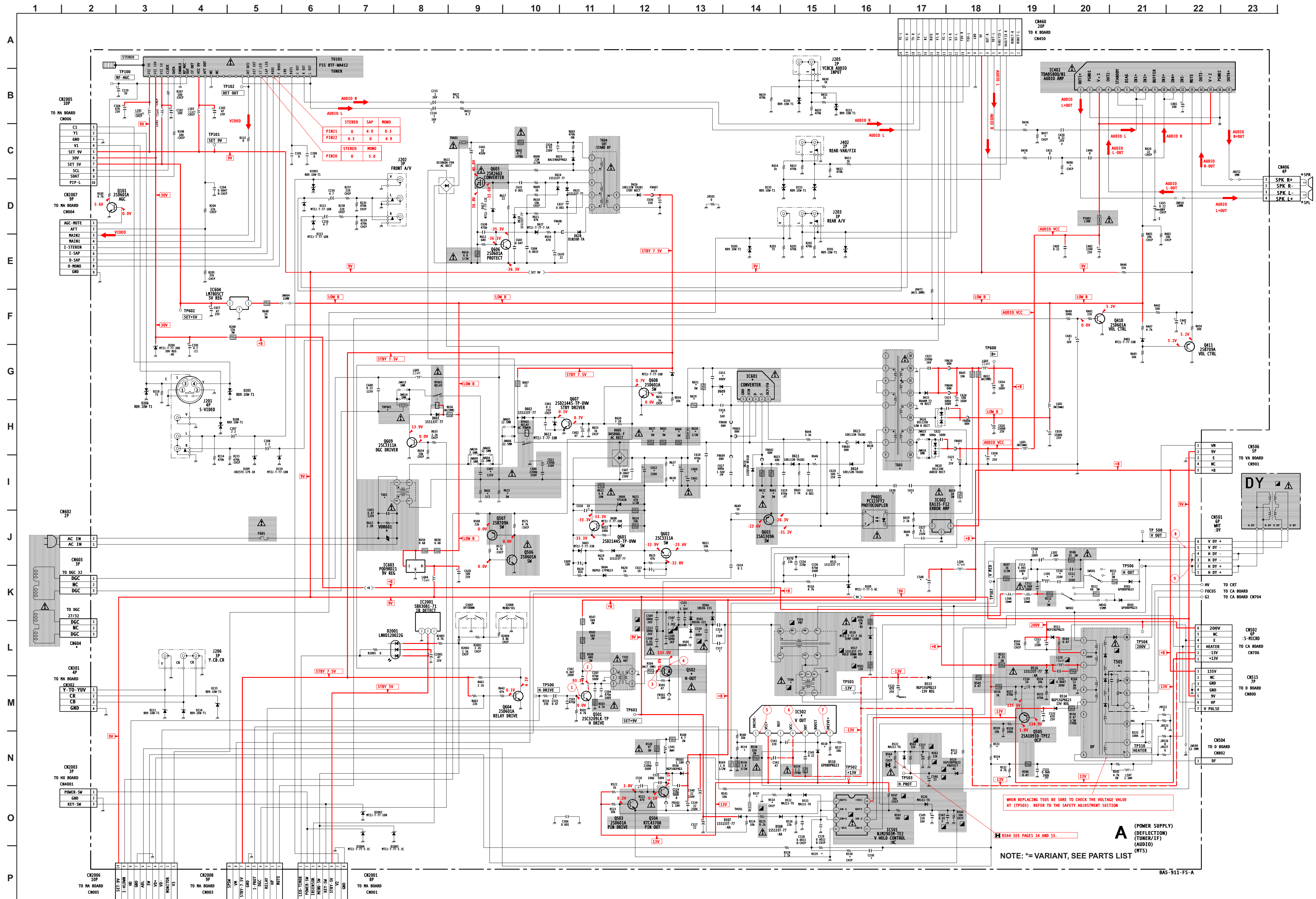

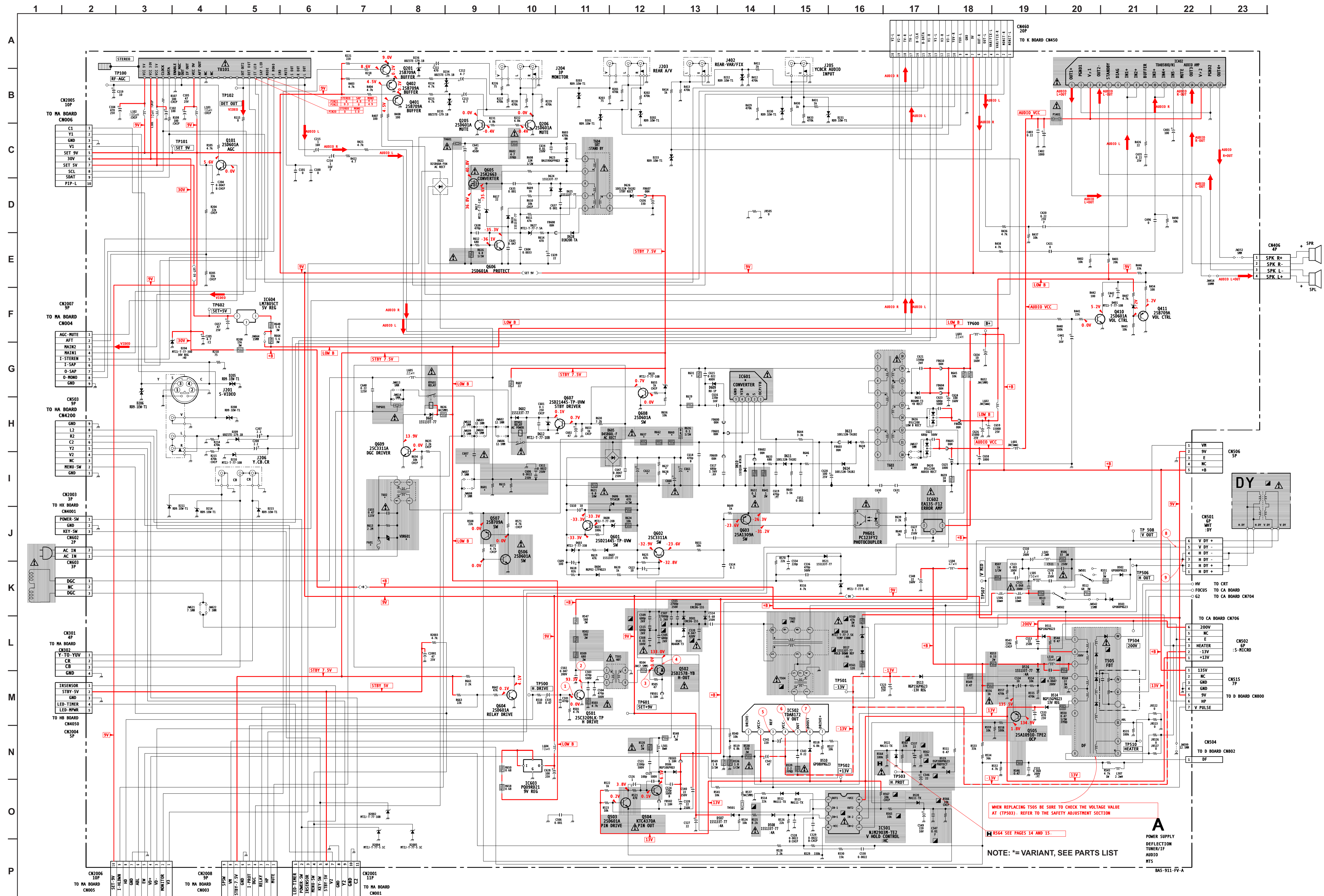

A BOARD WAVEFORMS

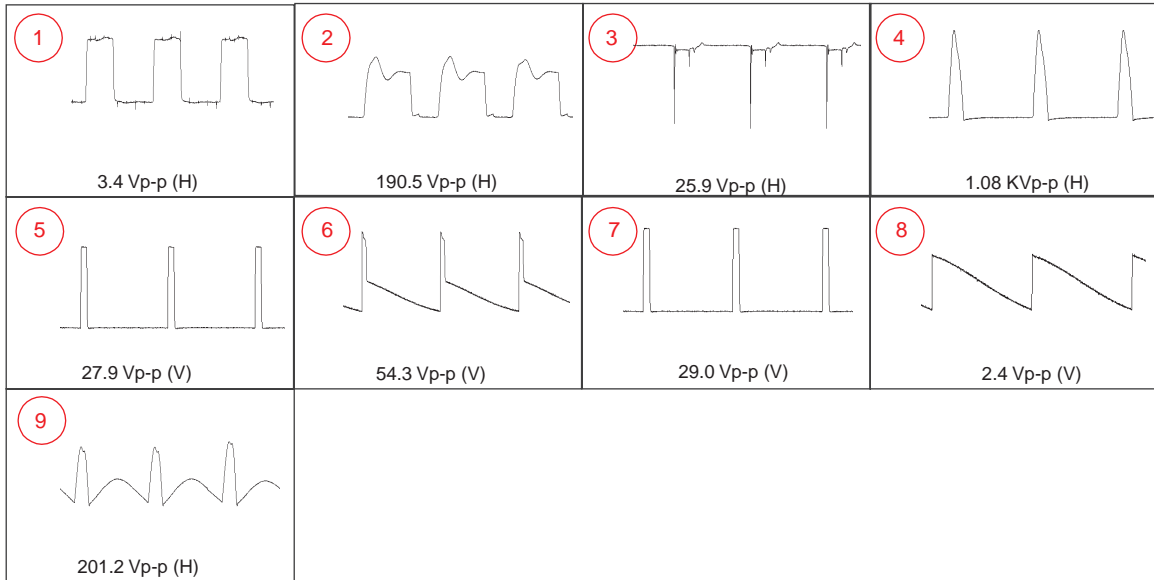

A BOARD IC VOLTAGE LIST

IC402		14	6.8	IC502		4	-23.8	IC604		2	30.7	15	N/C
PIN	VOLT	15	14.1	PIN	VOLT	5	-32.7	PIN	VOLT	3	5.1	16	4.5
1	6.8	16	GND	1	2.1	IC602		1	13.3	4	4.9	17	4.7
2	GND	17	6.8	2	14.0	PIN	VOLT	2	5.0	5	4.9	18	4.4
3	14.1	IC501		3	-12.6	1	135.9	3	GND	6	GND	19	5.0
4	6.8	PIN	VOLT	4	-13.9	2	123.4	IC2001		7	N/C	20	5.0
5	4.3	1	0.2	5	0.2	3	GND	PIN	VOLT	8	2.1	21	0.3
6	N/C	2	3.7	6	14.3	IC603		1	5	9	8.9	22	0.0
7	4.1	3	2.5	7	2.1	PIN	VOLT	2	5	10	4.1	23	N/C
8	4.1	4	GND	IC601		I	13.3	3	GND	11	GND	24	0.0
9	6.8	5	9.5	PIN	VOLT	O	8.9	TU101		12	N/C	25	N/C
10	4.1	6	10.1	1	-31.8	G	GND	PIN	VOLT	13	N/C	26	4.5
11	4.1	7	0.1	2	-32.7	4	13.3	1	8.6	14	N/C	27	4.5
12	4.1	8	14.0	3	53.2								
13	5.2												

All Voltages are in V

A BOARD IC BLOCK DIAGRAMS

IC402 TDA8580Q/N1

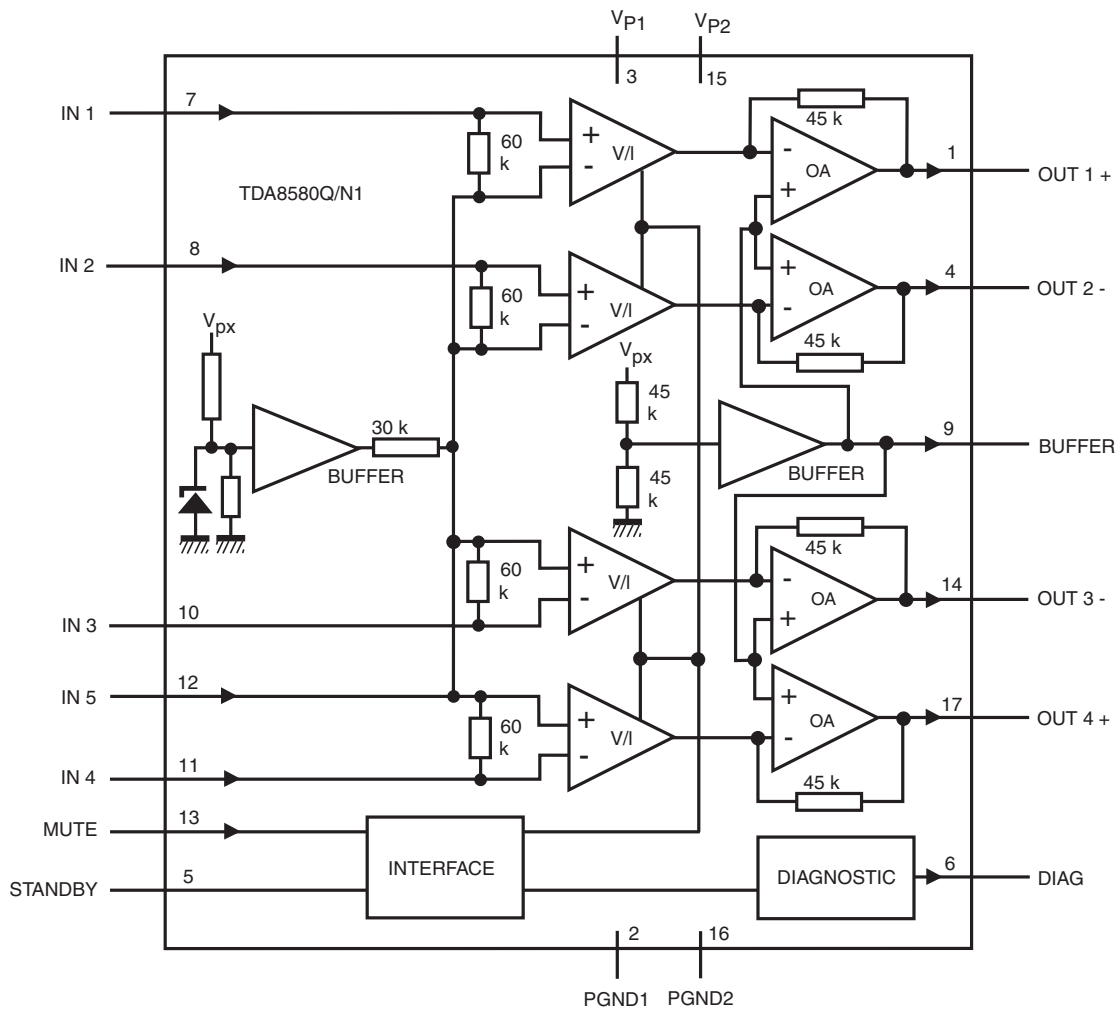

IC502 TDA8172

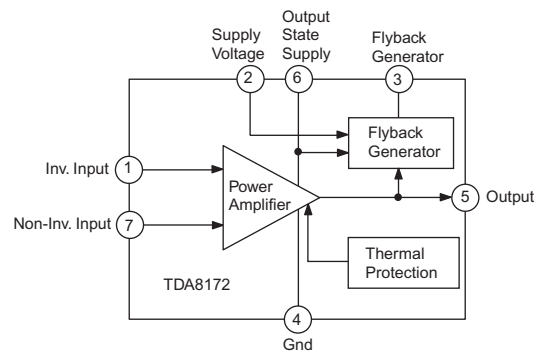

BC BOARD SCHEMATIC DIAGRAM

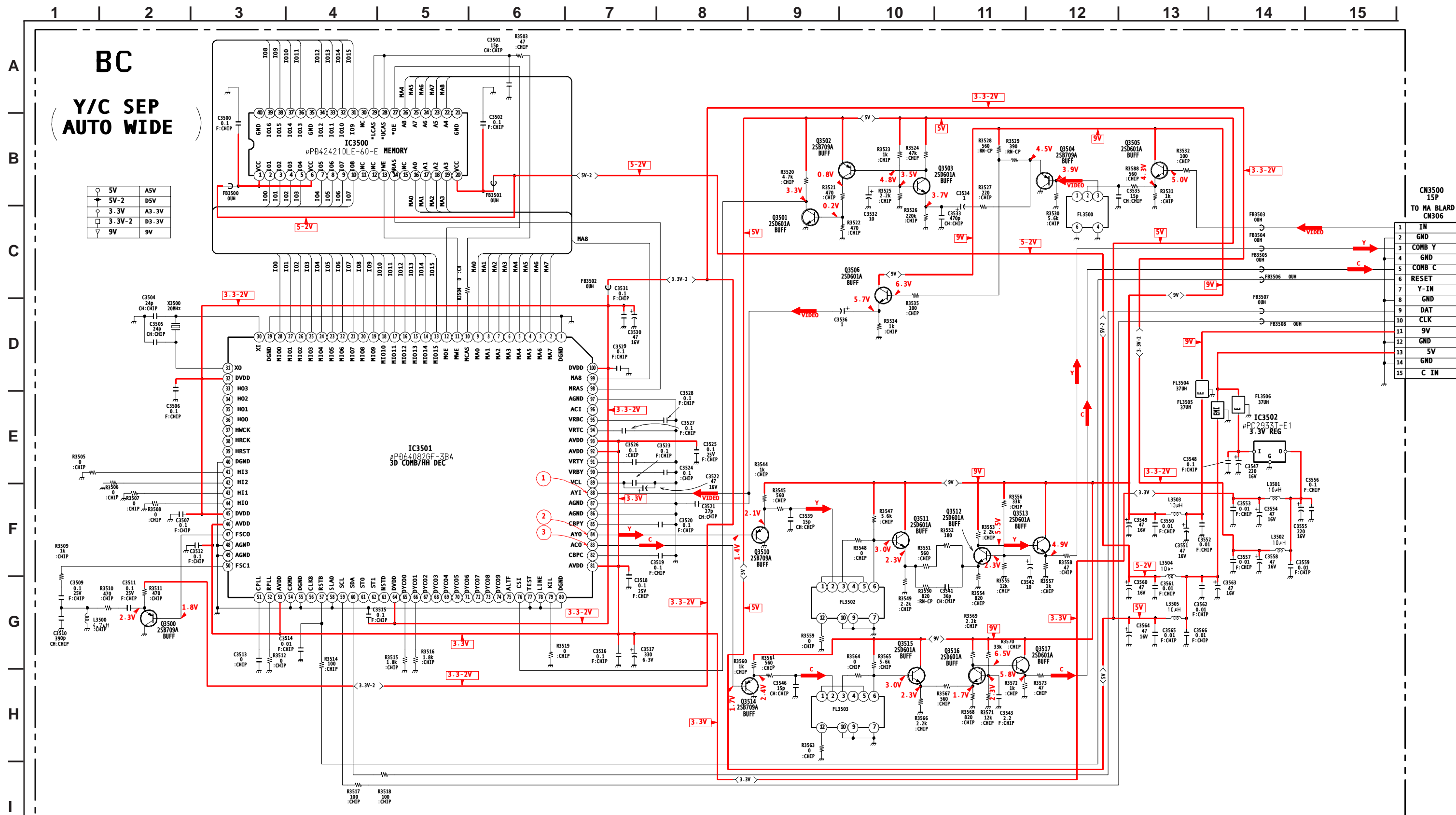

BC BOARD IC VOLTAGE LIST

IC3500		29	1.1	17	1.1	47	1.8	77	GND
PIN	VOLT	30	N/C	18	1.1	48	GND	78	GND
1	5.0	31	0.3	19	1.0	49	GND	79	0.0
2	0.8	32	1.1	20	0.1	50	1.5	80	GND
3	0.9	33	1.1	21	1.1	51	0.0	81	3.3
4	0.9	34	1.1	22	1.4	52	0.0	82	1.1
5	0.9	35	N/C	23	0.7	53	3.3	83	1.7
6	5.0	36	1.1	24	0.8	54	GND	84	1.4
7	0.8	37	1.1	25	0.9	55	GND	85	1.1
8	0.7	38	1.0	26	0.9	56	N/C	86	GND
9	1.4	39	0.1	27	0.9	57	3.3	87	GND
10	1.1	40	N/C	28	0.8	58	GND	88	0.9
11	N/C	IC3501		29	GND	59	4.8	89	0.9
12	N/C	PIN	VOLT	30	1.5	60	4.8	90	1.0
13	2.9	1	GND	31	1.6	61	N/C	91	1.6
14	0.5	2	1.5	32	3.3	62	N/C	92	3.3
15	N/C	3	1.5	33	N/C	63	N/C	93	3.3
16	1.5	4	1.5	34	N/C	64	3.3	94	3.3
17	1.5	5	1.5	35	N/C	65	0.7	95	2.0
18	1.5	6	1.5	36	N/C	66	1.5	96	N/C
19	1.5	7	1.5	37	N/C	67	N/C	97	GND
20	5.0	8	1.5	38	N/C	68	N/C	98	0.5
21	N/C	9	1.5	39	N/C	69	N/C	99	1.6
22	1.6	10	1.0	40	GND	70	N/C	100	3.3
23	1.5	11	2.9	41	0.0	71	N/C	IC3502	
24	1.5	12	2.4	42	0.0	72	N/C	PIN	VOLT
25	1.5	13	0.3	43	0.0	73	N/C	G	GND
26	1.5	14	1.1	44	0.0	74	N/C	I	5.0
27	2.4	15	1.1	45	3.3	75	N/C	O	3.3
28	1.1	16	1.1	46	3.3	76	3.3		

All Voltages are in V

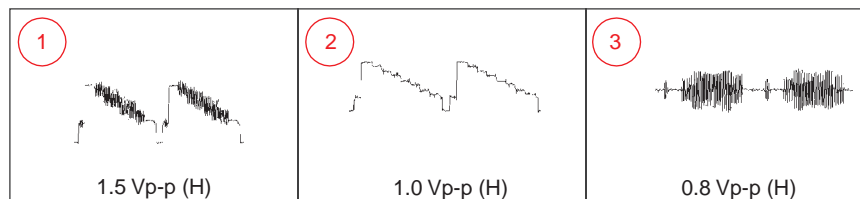
BC BOARD WAVEFORMS



COMPONENT SIDE (KV-27FV17/29FV17/29FV17C ONLY)

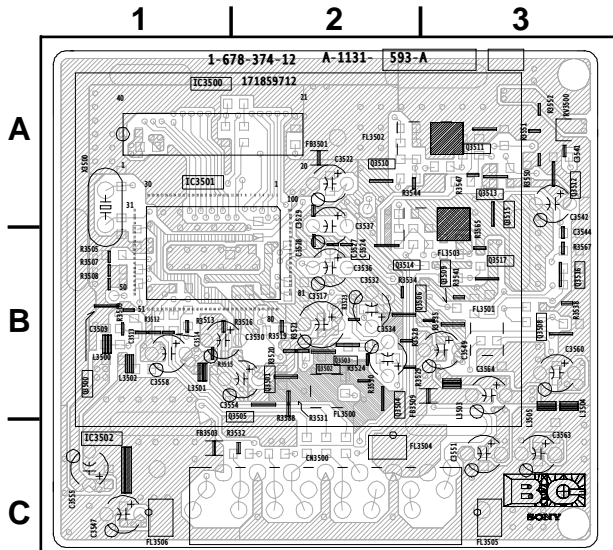

BC BOARD LOCATOR LIST

IC	Q3506	B-3	
IC3500	A-1	Q3510	A-2
IC3501	A-1	Q3511	A-3
IC3502	C-1	Q3512	A-3
TRANSISTOR		Q3513	A-3
Q3500	B-1	Q3514	B-2
Q3501	B-2	Q3515	A-3
Q3502	B-2	Q3516	B-3
Q3503	B-2	Q3517	B-3
Q3504	B-2		
Q3505	C-2		



CONDUCTOR SIDE (KV-27FV17/29FV17/29FV17C ONLY)

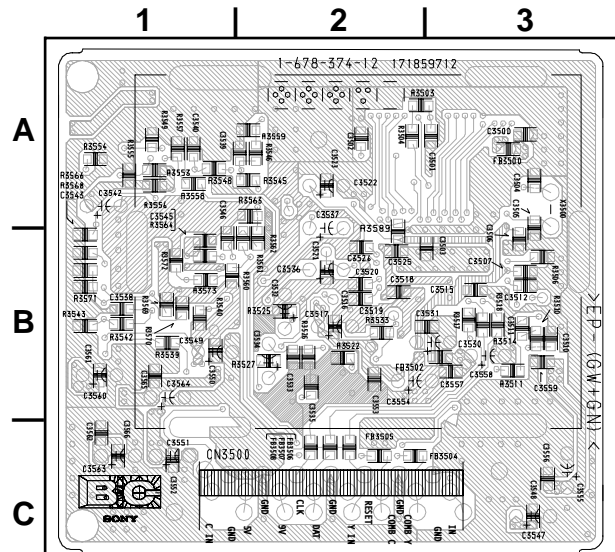

CA BOARD SCHEMATIC DIAGRAM

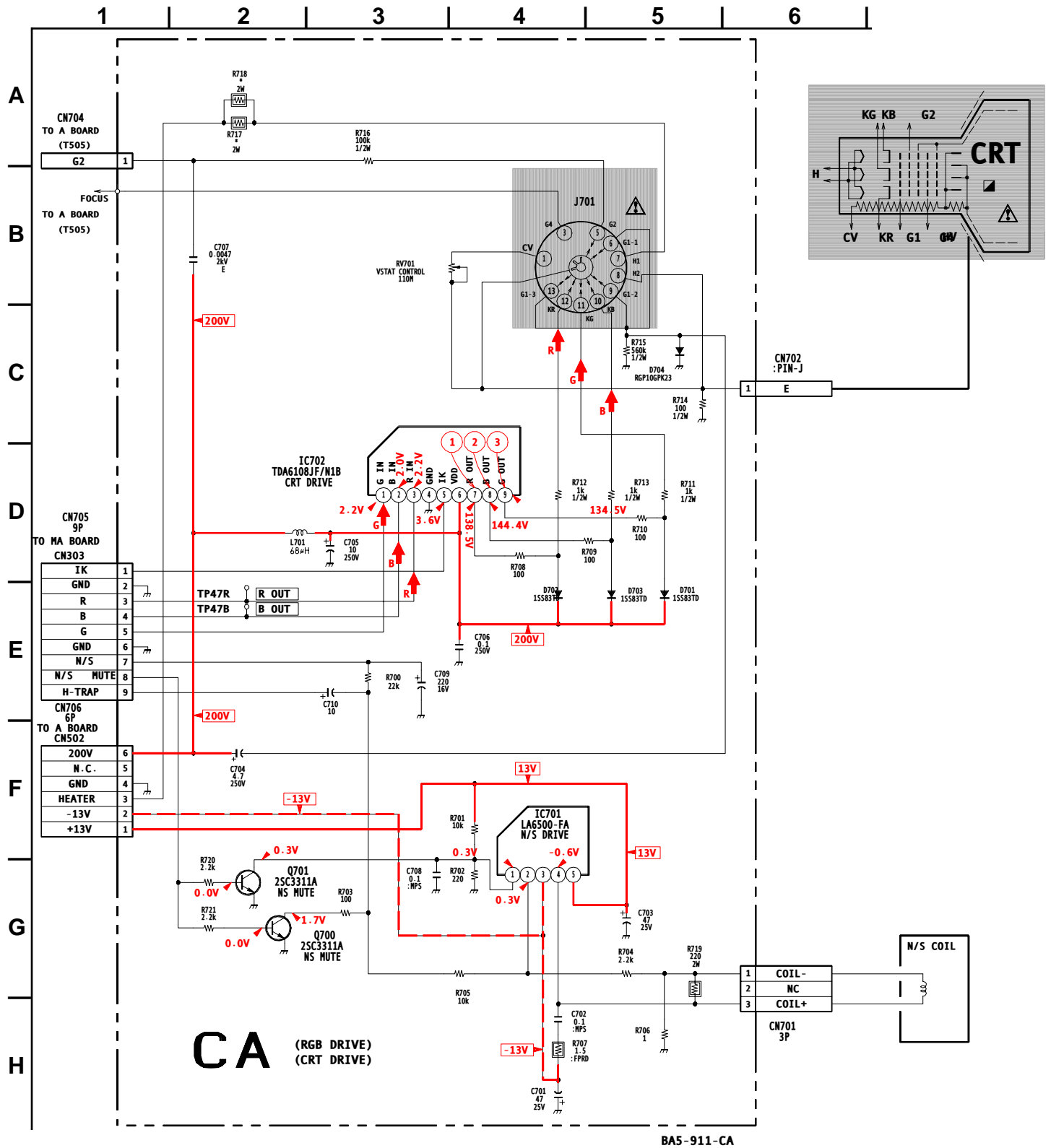

(*) CA BOARD VARIANT MODEL LIST

REF NO.	LOC.	KV-27FS13 KV-27FS17 KV-27FV17 KV-29FV17 KV-29FV17C	KV-32FS13 KV-32FS17 KV-34FS13C KV-34FS17
R717	B-2	2.2 2W	#
R718	B-2	#	2.2 2W

NOTE: # = Not Mounted

CA BOARD WAVEFORMS

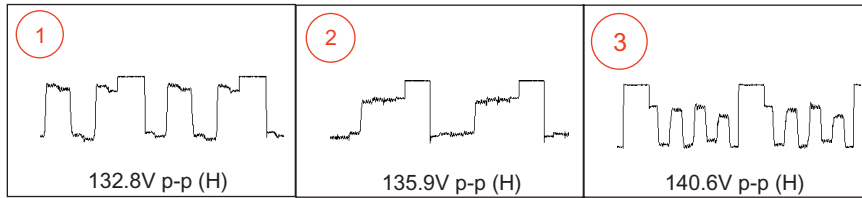

CA [RGB DRIVE, CRT DRIVE]

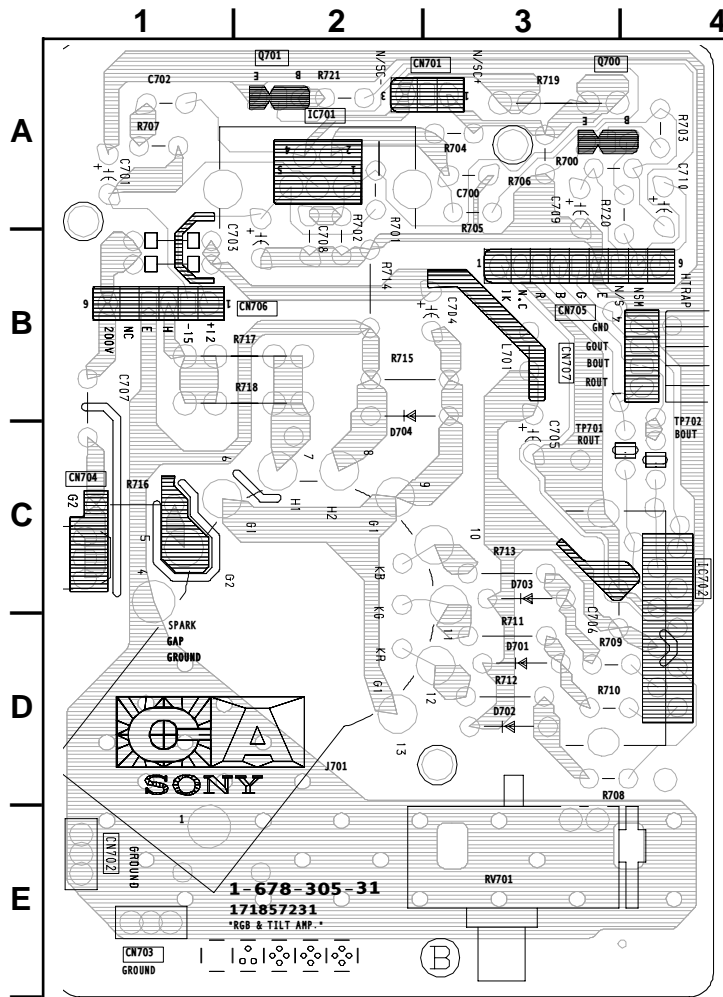

D BOARD SCHEMATIC DIAGRAM

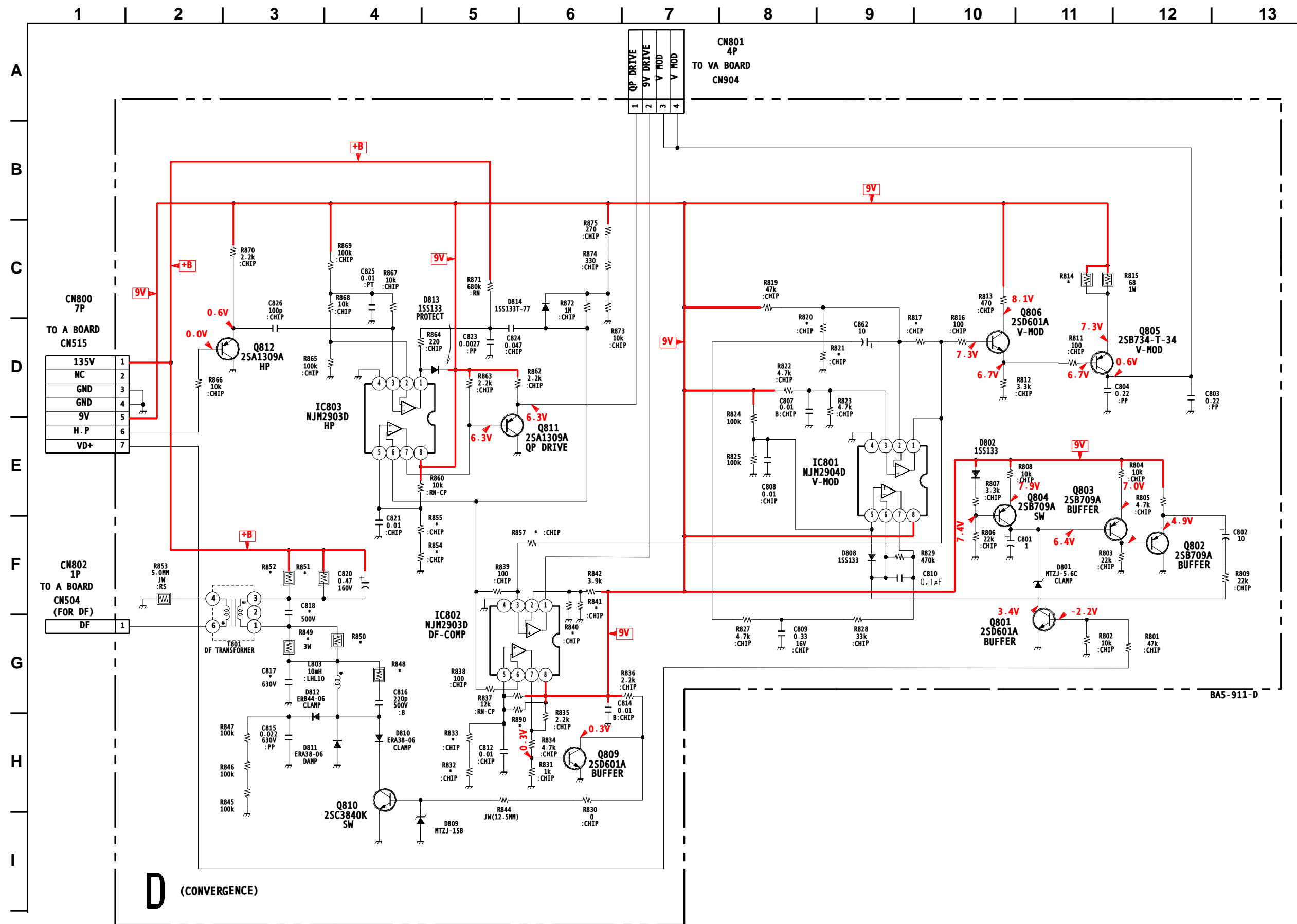

(*) D BOARD VARIANT MODEL LIST

REF NO.	LOC.	KV-27FS13 KV-27FS17 KV-27FV17 KV-29FV17 KV-29FV17C	KV-32FS13 KV-32FS17 KV-34FS13C KV-34FS17
C817	G-3	0.0039μF 630V	0.0027μF 630V
C818	F-3	0.0015μF 500V	680pF 500V
R814	C-11	#	68 1W
R817	D-10	56K	47K
R820	D-8	22K	33K
R821	D-9	15K	3.3K
R832	H-5	5.6K	3.3K
R833	H-5	33K	39K
R840	G-6	68K	#
R841	F-6	6.8K	10K
R848	C-11	15K 1W	2.2K 2W
R849	G-3	3.3K 3W	8.2K 3W
R850	G-4	#	8.2K 3W
R851	F-3	2.2K 2W	6.8K 3W
R852	F-3	#	6.8K 3W
R854	F-5	6.8K	5.6K
R855	F-5	47K	56K
R857	F-6	#	33K
R890	H-5	#	100K

NOTE: #- Not Mounted

D BOARD IC VOLTAGE LIST

IC801		IC802		IC803	
PIN	VOLT	PIN	VOLT	PIN	VOLT
1	7.3	1	6.8	1	2.3
2	4.4	2	5.7	2	4.3
3	4.5	3	0.0	3	4.7
4	GND	4	GND	4	GND
5	4.5	5	6.8	5	7.6
6	4.5	6	6.7	6	6.7
7	4.5	7	3.2	7	6.0
8	9.0	8	9.0	8	9.0

All Voltages are in V

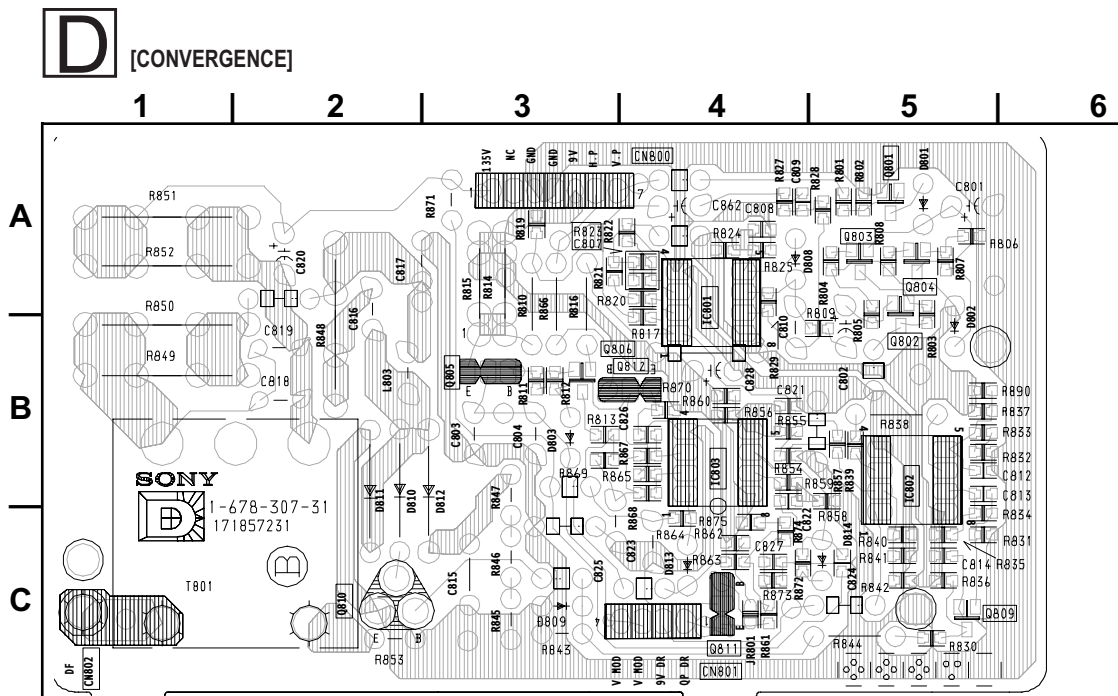

HA BOARD SCHEMATIC DIAGRAM (KV-27FV17/29FV17/29FV17C ONLY)

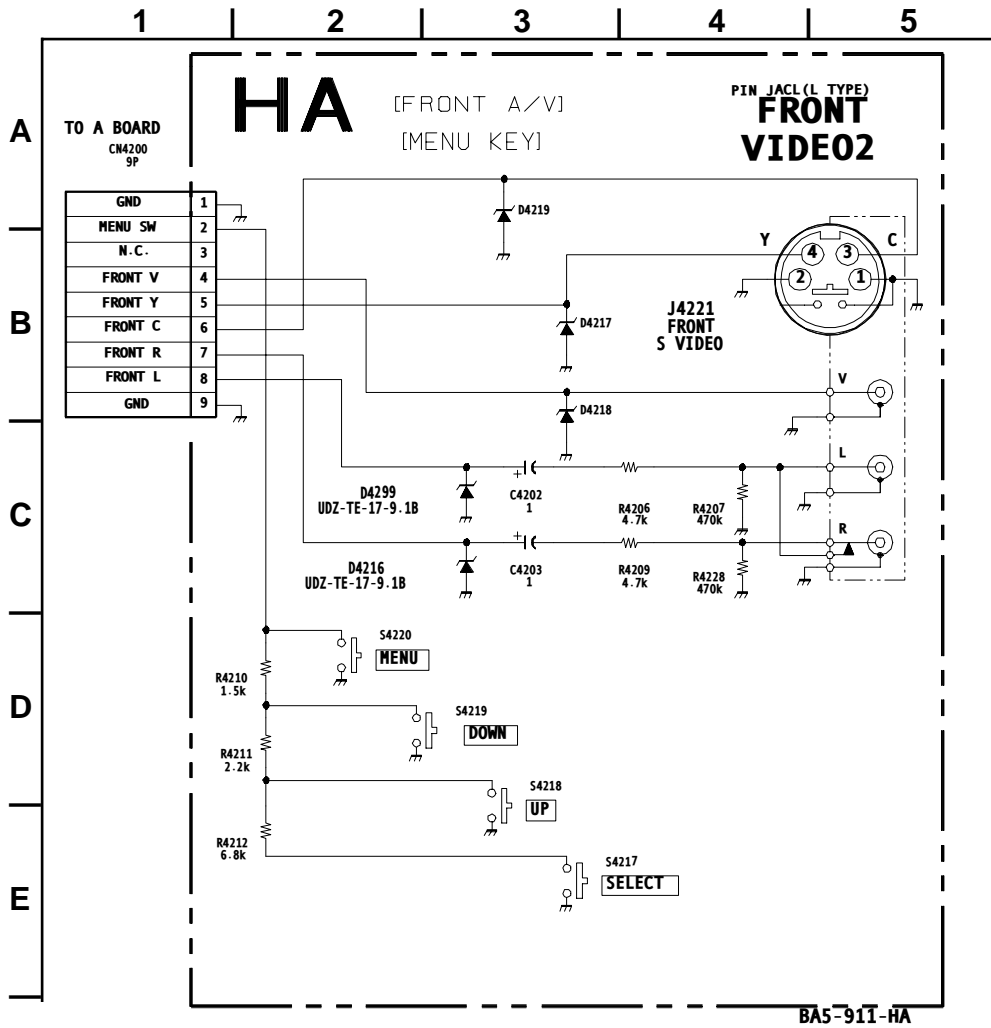

HA [FRONT/AV, MENU KEY]

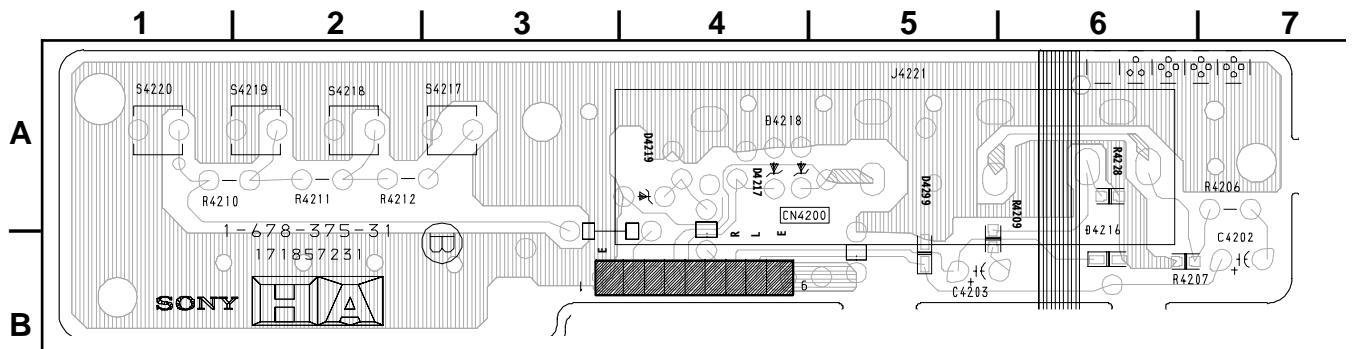

HB BOARD SCHEMATIC DIAGRAM (KV-27FV17/9FV17/29FV17C ONLY)

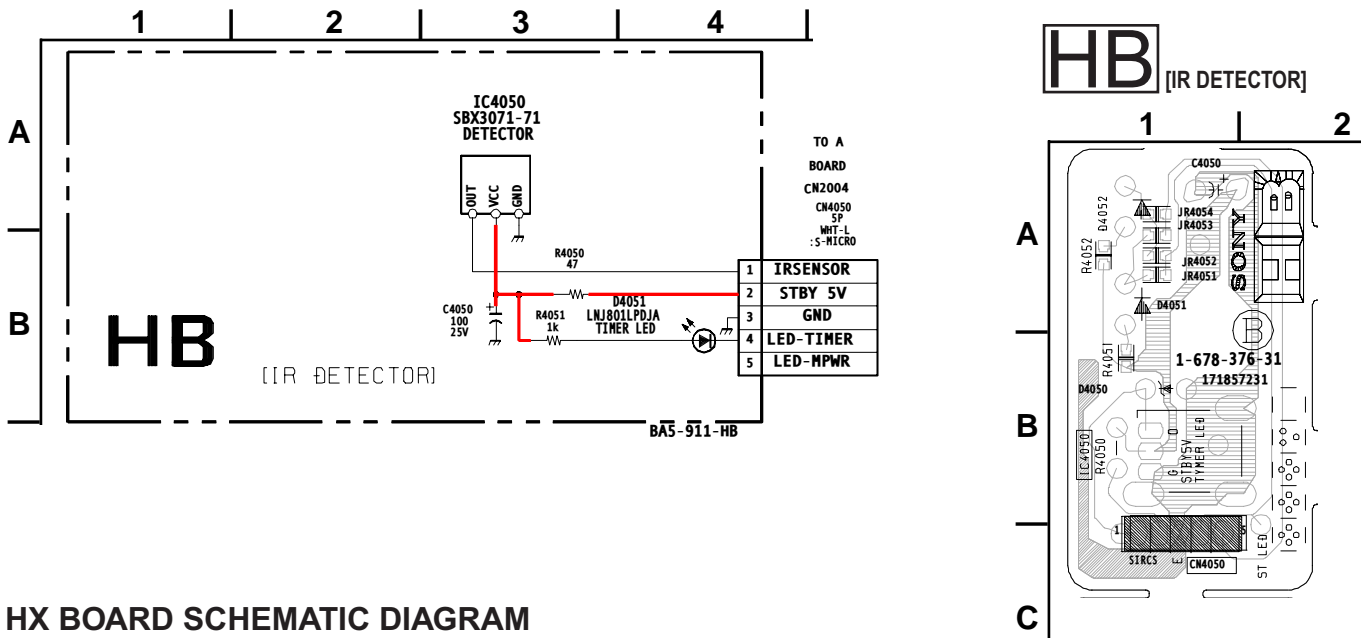

HX BOARD SCHEMATIC DIAGRAM

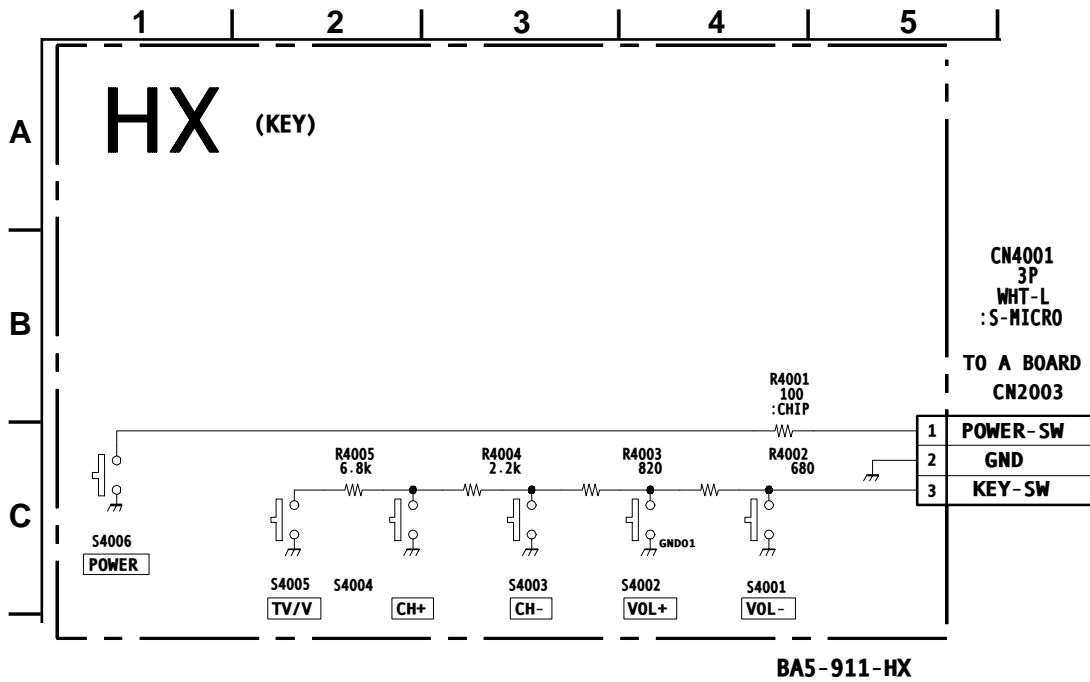

HX [KEY]

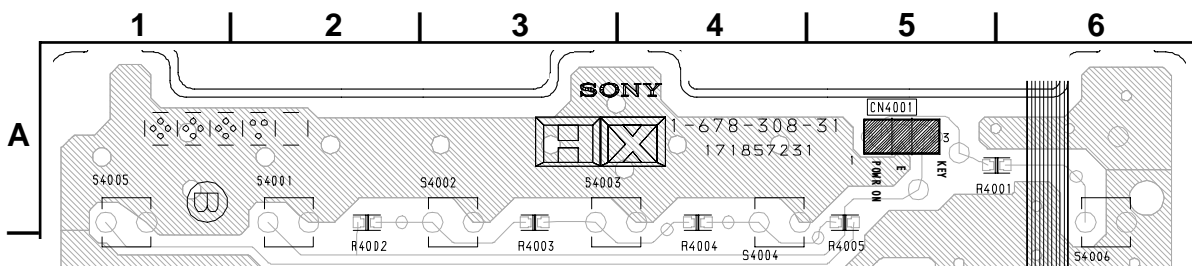

K BOARD SCHEMATIC DIAGRAM

KV-27FS13/ 27FS17/ 27FV17/ 29FV17/ 29FV17C/ 32FS13/ 32FS17/ 34FS13C/ 34FS17

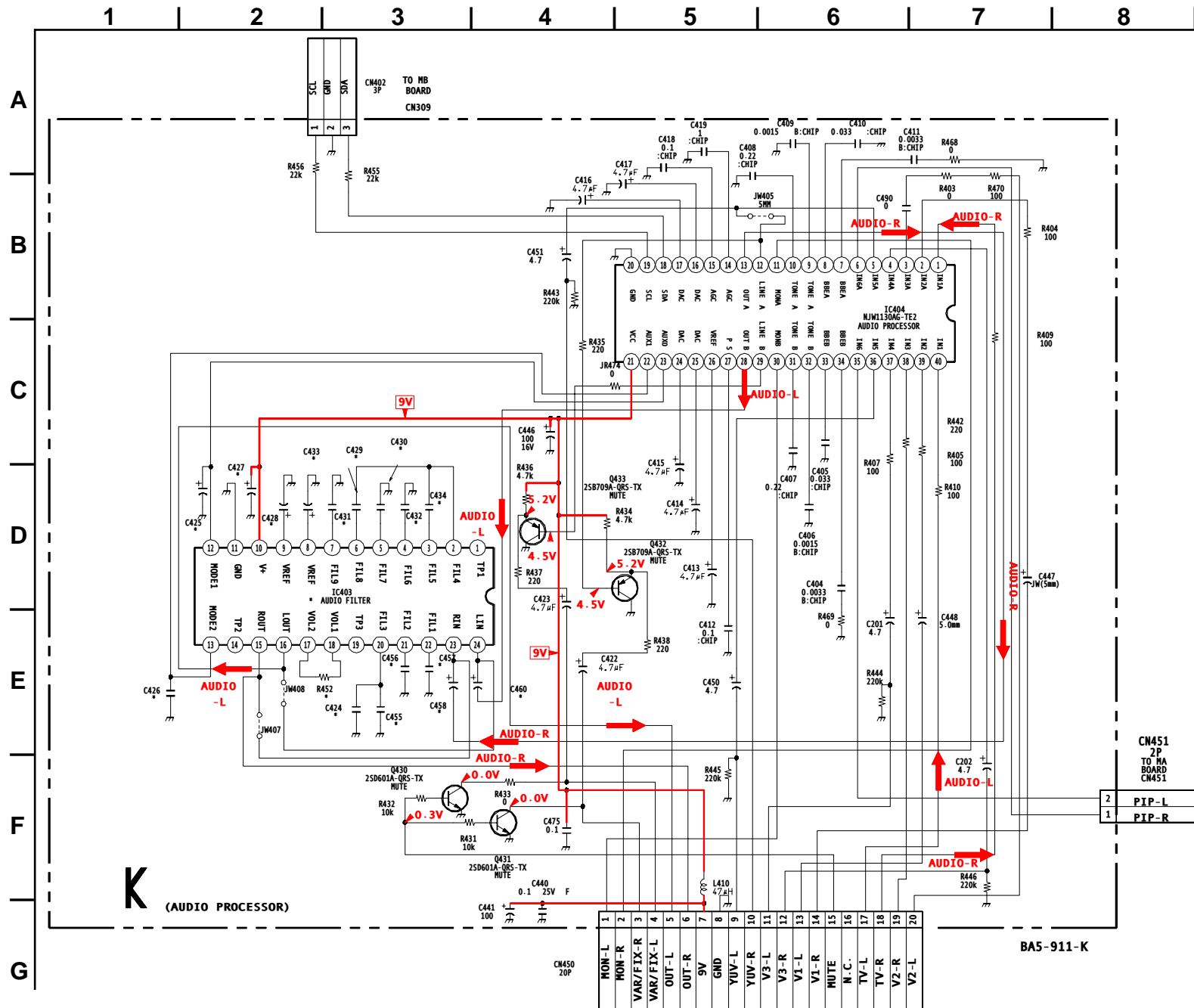

K BOARD IC VOLTAGE LIST

IC403		16	4.5	7	4.7	24	1.3
PIN	VOLT	17	4.5	8	4.5	25	1.3
1	N/C	18	4.5	9	4.5	26	4.4
2	4.5	19	N/C	10	4.5	27	3.9
3	4.5	20	4.5	11	4.5	28	4.5
4	4.5	21	4.5	12	4.5	29	4.5
5	4.5	22	4.5	13	4.5	30	4.5
6	4.5	23	4.5	14	1.0	31	4.5
7	4.5	24	4.5	15	4.5	32	4.5
8	4.5	IC404		16	0.9	33	4.5
9	4.5	PIN	VOLT	17	0.9	34	4.5
10	9.0	1	4.5	18	4.8	35	4.5
11	GND	2	4.5	19	4.9	36	4.5
12	0.0	3	4.5	20	GND	37	4.5
13	0.0	4	4.5	21	8.9	38	4.5
14	N/C	5	4.5	22	0.0	39	4.5
15	4.5	6	4.5	23	0.0	40	4.5

All voltages are in V

(*) K BOARD VARIANT MODEL LIST

REF NO.	LOC.	KV-27FS13 KV-27FS17 KV-32FS13 KV-32FS17 KV-34FS13C KV-34FS17	KV-27FV17 KV-29FV17 KV-29FV17C
C424	E-3	#	0.47µF 25V
C425	D-2	#	1µF 16V
C426	E-2	#	1µF
C427	D-1	#	100µF
C428	D-1	#	100µF
C429	C-3	#	0.0047µF
C430	D-3	#	0.22µF 25V
C431	D-3	#	0.1µF 25V
C432	D-3	#	0.01µF
C433	D-3	#	1µF 16V
C434	D-3	#	0.1µF 25V
C455	E-3	#	0.47µF25V
C456	E-3	#	0.01µF
C457	E-4	#	0.033µF
C458	E-3	#	4.7µF
C460	E-4	#	4.7µF
IC403	D-2	#	NJM2198-TE2
R452	E-2	#	10K

NOTE: # = Not Mounted

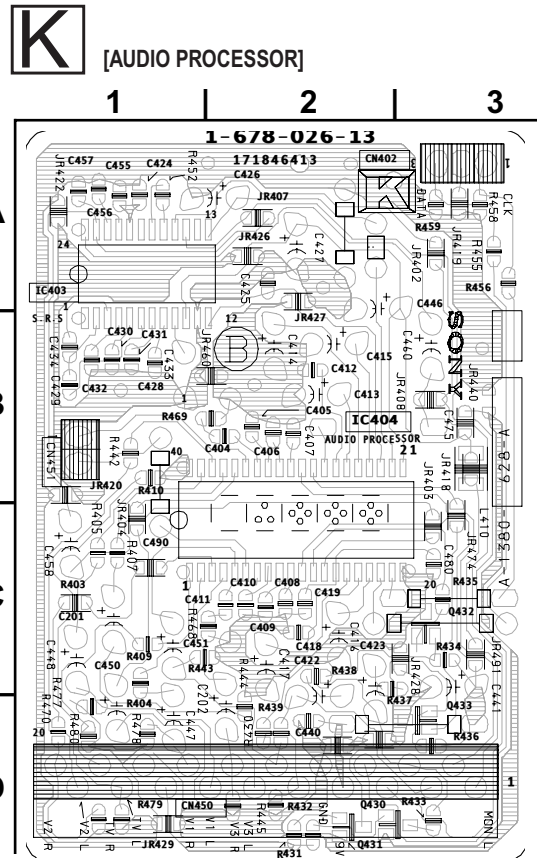

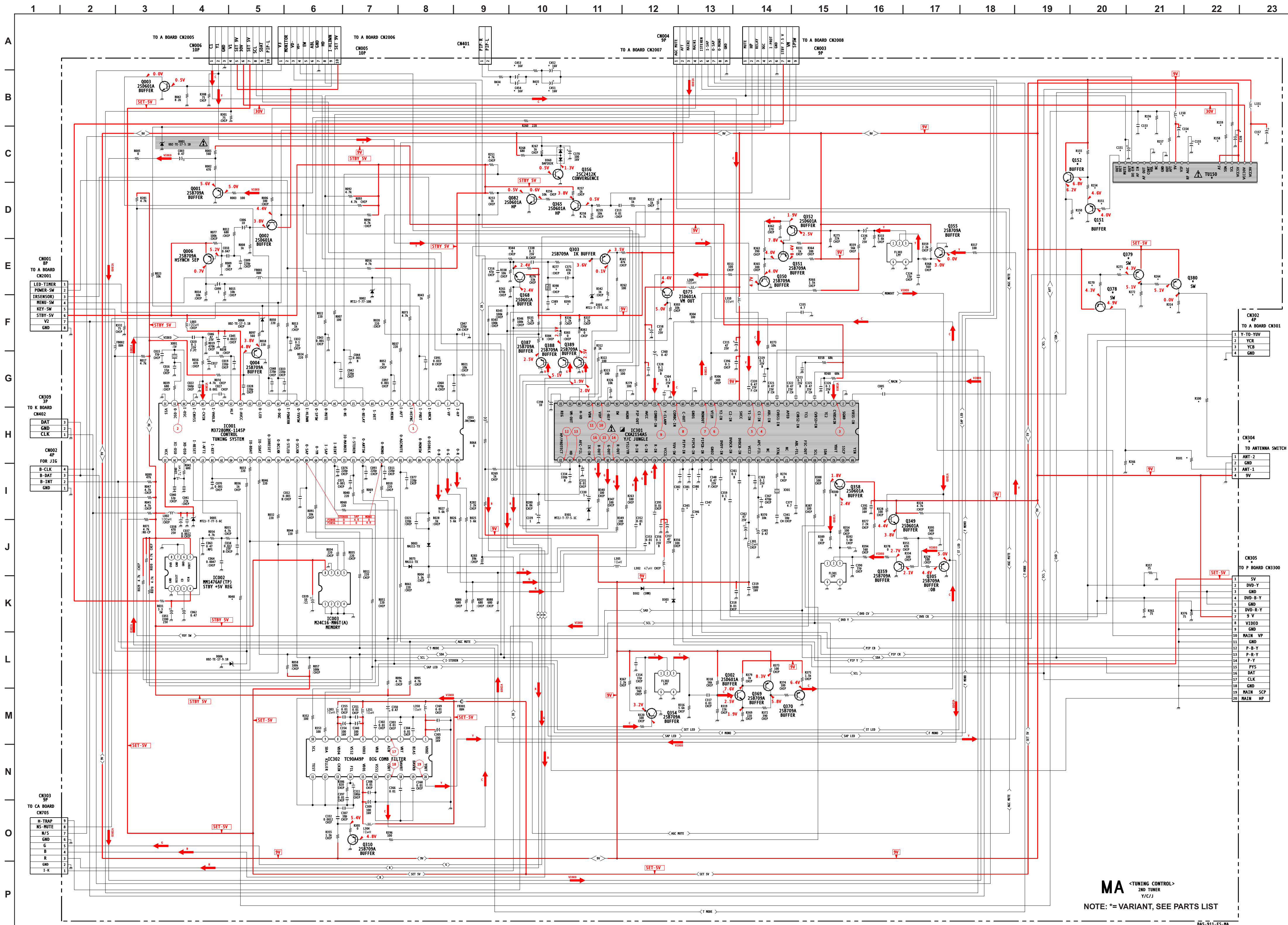

MA <TUNING CONTROL>
2ND TUNER
V1C13

NOTE: * = VARIANT, SEE PARTS LIST

MA BOARD SCHEMATIC DIAGRAM (KV-27FV17/29FV17/29FV17C ONLY)

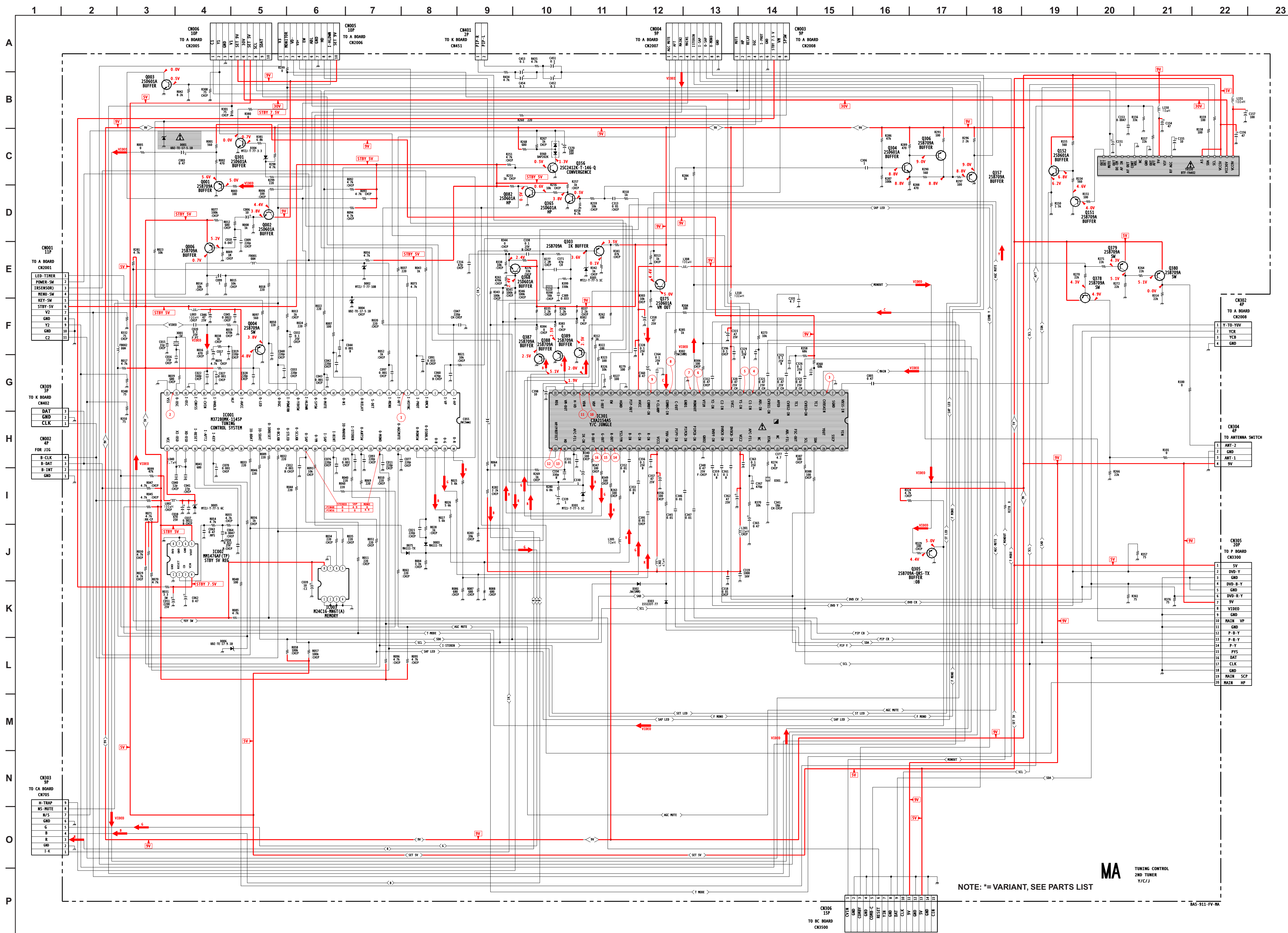

CK001 11P
TO A BOARD
CK205

1	LED-TIMER
2	POWER-SM
3	INSEKSON
4	REMO-SM
5	KEY-SM
6	STBY-SV
7	V2
8	GND
9	V2
10	GND
11	C2

CK003 3P
TO K BOARD
CK002

1	DAT
2	GND
3	CLK

CK002 3P
FOR JIG

1	B-CLK
2	B-DAT
3	B-TXT
4	GND

CK003 3P
TO CA BOARD
CK705

1	MS-TROP
2	MS-WRITE
3	N/S
4	GND
5	G
6	B
7	R
8	GND
9	L-K

CK002 4P
TO A BOARD
CK208

1	Y-TO-YVW
2	YCR
3	YCB
4	GND

CK004
TO ANTENNA SWITCH

1	ANT-2
2	GND
3	ANT-1
4	5V

CK005 10P
TO P BOARD
CK300

1	5V
2	DVD-Y
3	GND
4	DVD-B-Y
5	GND
6	DVD-R-Y
7	5V
8	VIDEO
9	GND
10	MAIN VP
11	GND
12	P-B-Y
13	P-R-Y
14	P-Y
15	PYS
16	DAT
17	CLK
18	GND
19	MAIN SCP
20	MAIN HP

CK306 15P
TO BC BOARD
CK350

1	CVEN
2	GND
3	COMB-V
4	COMB-L
5	RESET
6	DATA
7	DATA
8	DATA
9	DATA
10	DATA
11	DATA
12	DATA
13	DATA
14	DATA
15	DATA

NOTE: * = VARIANT, SEE PARTS LIST

MA
TUNING CONTROL
2ND TUNER
Y/C/J

BA5-911-PV-06

MA BOARD IC VOLTAGE LIST

IC001		23	N/C	47	4.8	5	5.0	9	N/C	33	3.6	57	N/C	15	5.0	17	GND	
PIN	VOLT	24	5.0	48	0.1	6	GND	10	N/C	34	2.3	58	7.2	16	0.0	18	N/C	
1	0.5	25	2.1	49	0.1	7	GND	11	0.0	35	2.3	59	4.8	17	2.5	19	N/C	
2	4.8	26	N/C	50	5.0	8	N/C	12	N/C	36	3.9	60	4.8	18	3.2	20	2.0	
3	N/C	27	0.3	51	5.0	IC003			13	8.9	37	1.9	61	4.8	19	1.9	21	0.3
4	5.0	28	2.2	52	N/C	PIN	VOLT	14	N/C	38	1.9	62	N/C	20	2.4	22	4.0	
5	0.0	29	GND	53	1.0	1	GND	15	N/C	39	2.0	63	N/C	TU150				
6	0.0	30	2.2	54	0.1	2	GND	16	4.8	40	0.0	64	N/C	PIN	VOLT			
7	2.4	31	2.3	55	N/C	3	GND	17	4.4	41	4.6	IC302		1	9.0			
8	4.4	32	GND	56	1.0	4	GND	18	GND	42	4.6	PIN	VOLT	2	3.0			
9	N/C	33	5.0	57	N/C	5	4.8	19	N/C	43	4.6	1	5.0	3	5.0			
10	N/C	34	2.5	58	0.1	6	4.8	20	6.4	44	8.9	2	1.4	4	4.8			
11	0.1	35	2.5	59	N/C	7	GND	21	3.9	45	0.2	3	3.2	5	4.8			
12	N/C	36	5.0	60	N/C	8	5.0	22	5.6	46	4.3	4	2.4	6	5.1			
13	0.5	37	3.1	61	0.1	IC301			23	8.9	47	5.2	5	1.9	7	N/C		
14	N/C	38	5.0	62	0.1	PIN	VOLT	24	5.7	48	5.2	6	5.0	8	N/C			
15	0.1	39	N/C	63	0.1	1	5.9	25	GND	49	GND	7	0.0	9	N/C			
16	0.1	40	N/C	64	0.1	2	5.2	26	3.5	50	4.8	8	5.0	10	N/C			
17	0.0	41	N/C	IC002			3	N/C	27	2.4	51	5.2	9	4.9	11	7.5		
18	0.1	42	4.8	PIN	VOLT	4	5.0	28	3.5	52	5.2	10	4.9	12	N/C			
19	4.3	43	4.8	1	GND	5	4.8	29	3.5	53	9.0	11	0.0	13	9.0			
20	0.1	44	N/C	2	5.0	6	5.0	30	5.9	54	5.3	12	0.0	14	5.3			
21	N/C	45	4.8	3	4.9	7	4.8	31	5.5	55	N/C	13	2.5	15	GND			
22	5.0	46	N/C	4	7.2	8	3.4	32	7.6	56	1.7	14	2.1	16	N/C			

All Voltages are in V

MA BOARD WAVEFORMS

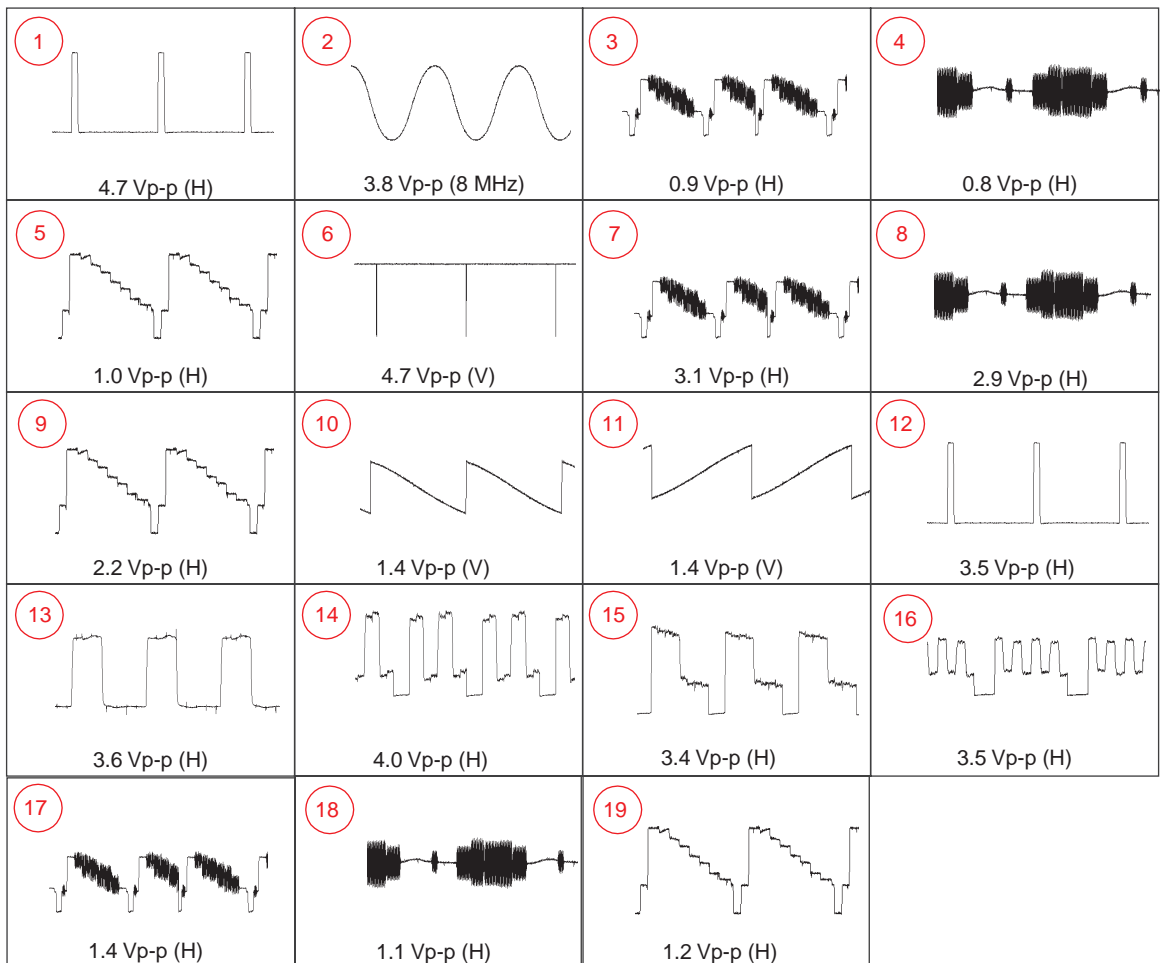

MA BOARD IC BLOCK DIAGRAM

IC301 CXA2154AS

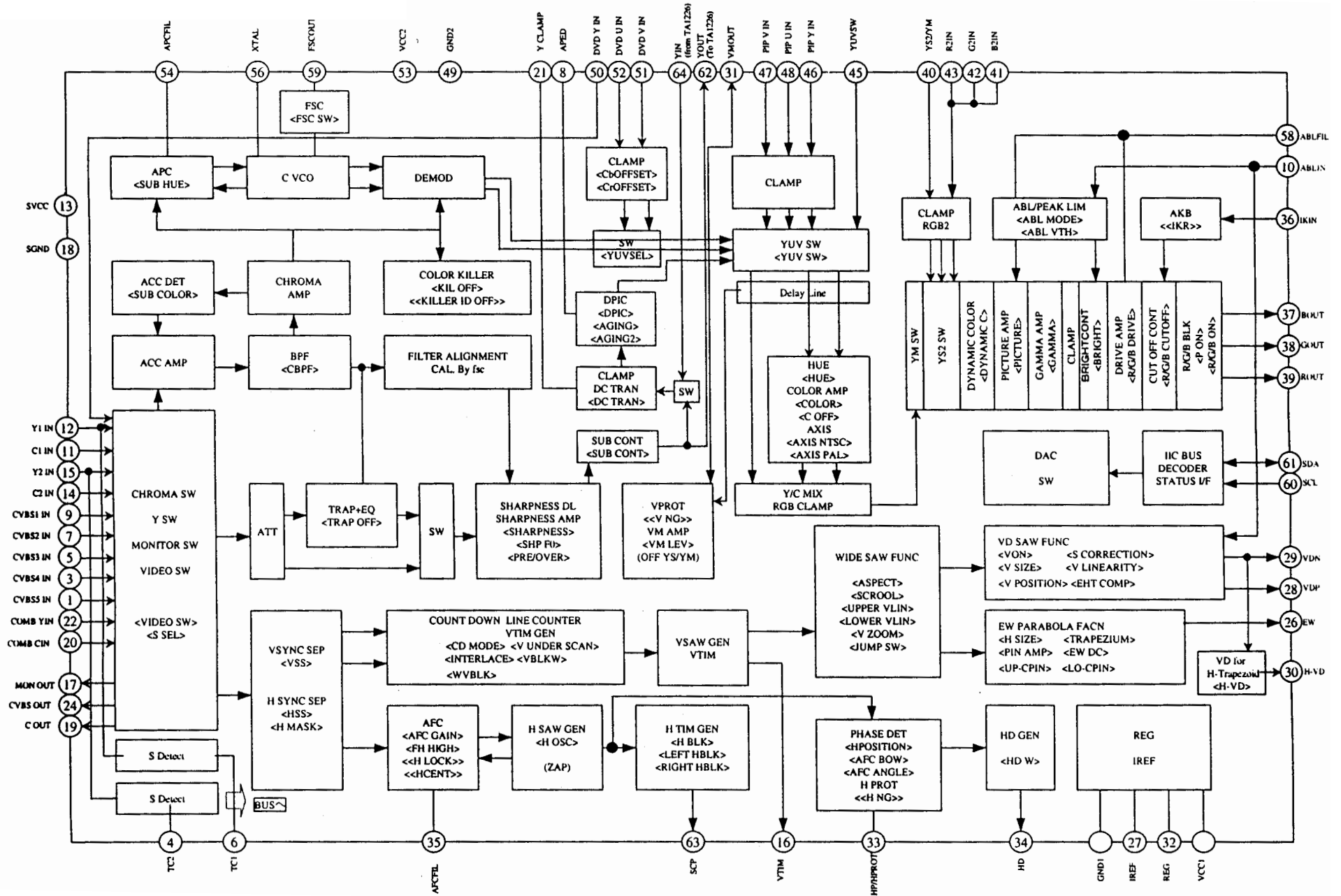

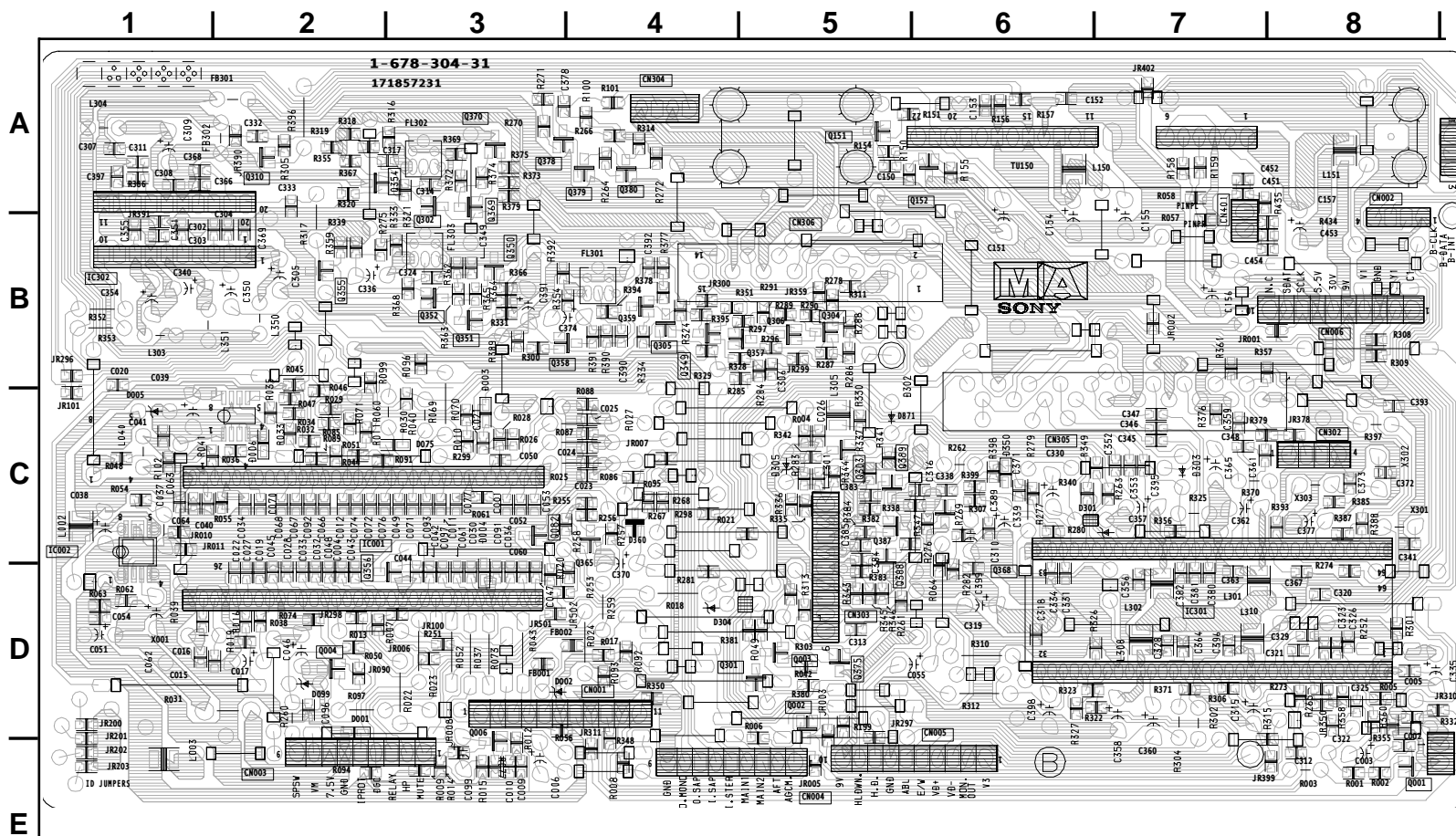

MA BOARD LOCATOR LIST

DIODE	IC	Q151	A-5	Q358	B-4	CRYSTAL			
D001	D-2	IC001	C-2	Q152	A-6	Q359	B-4	X001	D-1
D002	D-4	IC002	C-1	Q302	A-3	Q365	C-4	X301	C-8
D003	C-3	IC003	C-2	Q303	C-5	Q368	C-6		
D004	D-3	IC301	D-7	Q305	B-4	Q369	B-3		
D005	C-1	IC302	B-1	Q310	B-3	Q370	A-3		
D006	C-2	TRANSISTOR		Q349	C-4	Q375	B-5		
D075	C-3	Q001	D-8	Q350	B-3	Q378	A-3		
D301	C-7	Q002	D-5	Q351	B-3	Q379	A-4		
D302	C-5	Q003	D-5	Q352	B-3	Q380	A-4		
D303	C-7	Q004	D-2	Q354	A-3	Q387	C-5		
D305	B-5	Q006	D-3	Q355	B-2	Q388	B-5		
D360	B-4	Q082	B-3	Q356	D-3	Q389	C-5		

P BOARD SCHEMATIC DIAGRAM (KV-27FS17/27FV17/29FV17/29FV17C/32FS17/34FS17 ONLY)

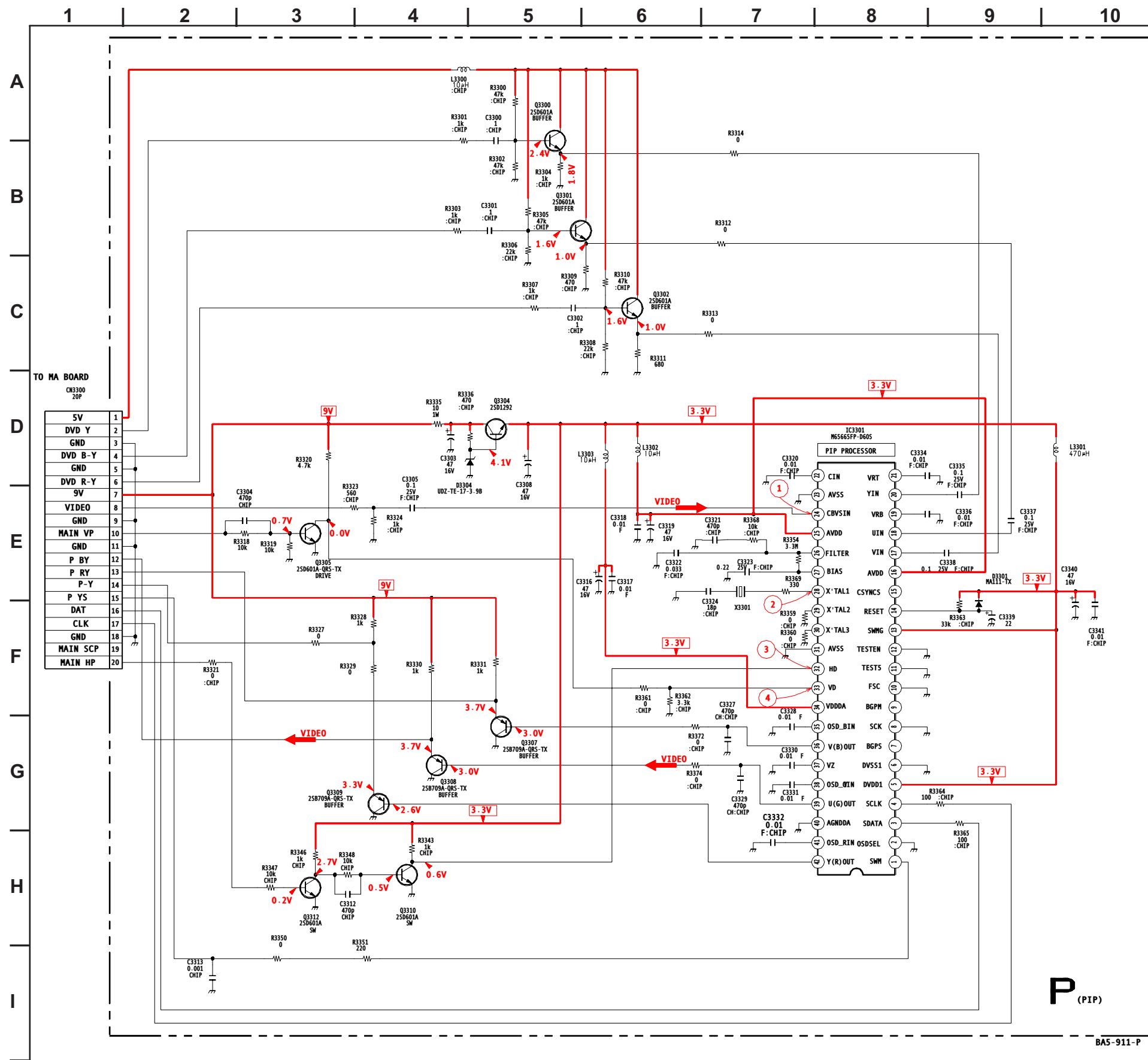

P [PIP]
COMPONENT SIDE

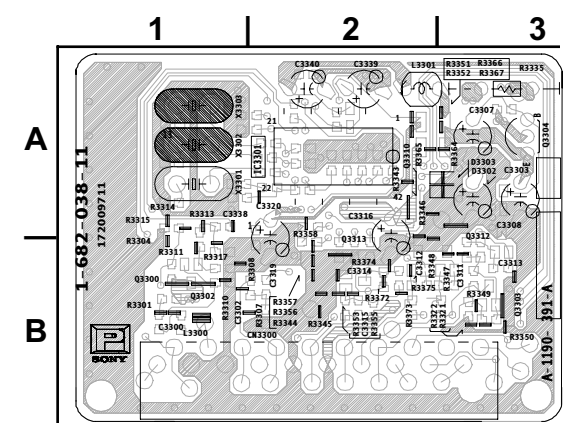

CONDUCTOR SIDE

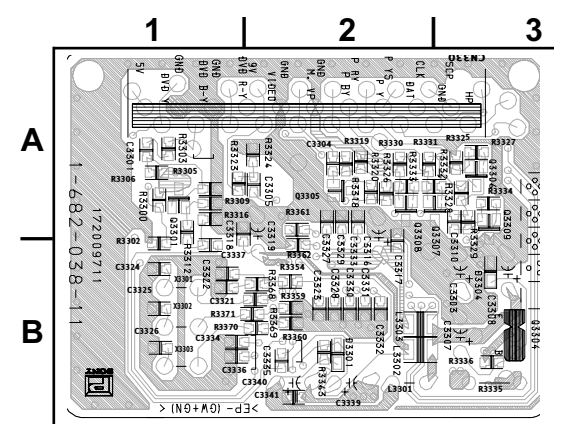

P BOARD IC VOLTAGE LIST

IC3301		24	3.4
PIN	VOLT	25	3.4
1	0.2	26	1.4
2	GND	27	1.7
3	4.7	28	2.0
4	4.8	29	0.0
5	3.2	30	0.0
6	GND	31	0.0
7	0.0	32	0.5
8	GND	33	0.0
9	N/C	34	GND
10	N/C	35	3.1
11	GND	36	1.1
12	GND	37	3.0
13	3.2	38	1.2
14	3.2	39	2.6
15	3.2	40	3.5
16	GND	41	1.0
17	GND	42	GND
18	0.3		
19	GND		
20	0.5		
21	1.6		
22	1.0		
23	0.6		

All voltages are in V

P BOARD WAVEFORMS

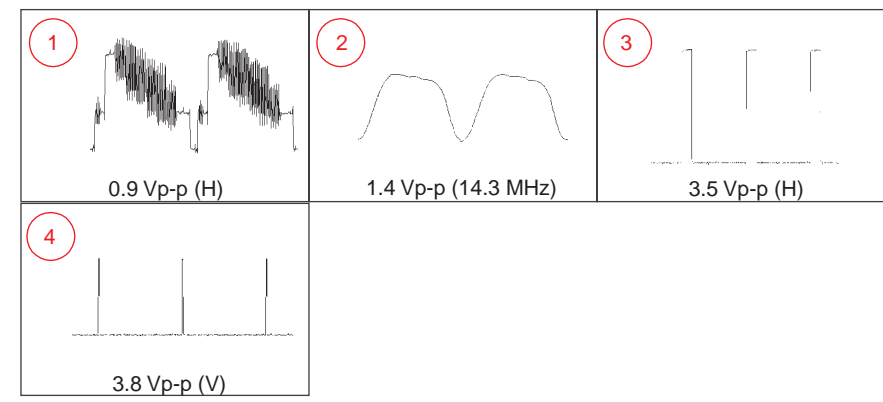

P (PIP)

BA5-911-P

VA BOARD SCHEMATIC DIAGRAM

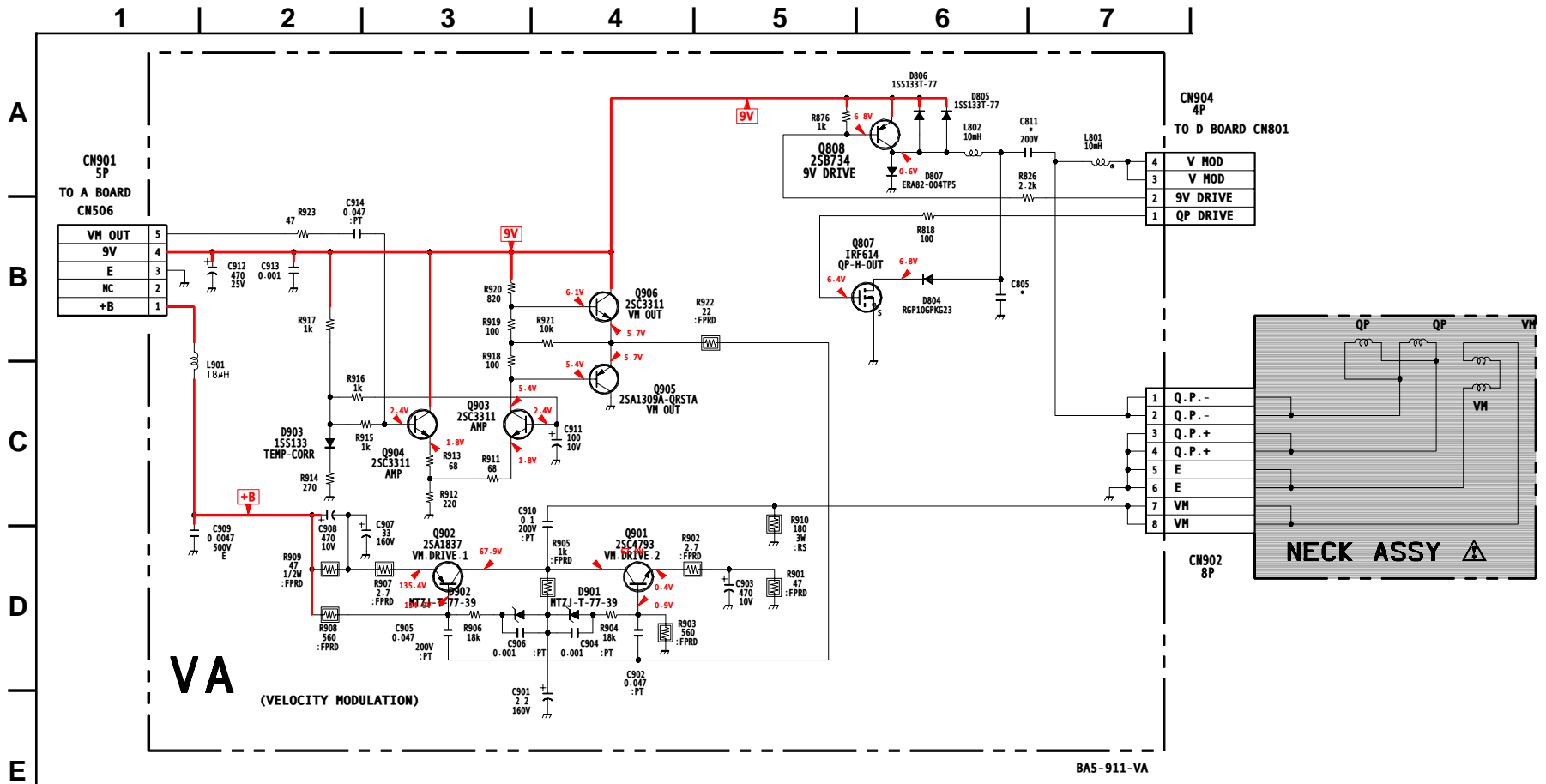



(*) VA BOARD VARIANT MODEL LIST

REF NO.	LOC.	KV-27FS13 KV-27FS17 KV-27FV17 KV-29FV17 KV-29FV17C	KV-32FS13 KV-32FS17 KV-34FS13C KV-34FS17
C805	B-6	0.033μF 200V	0.01μF 630V
C811	A-6	0.047μF 200V	0.082μF 200V

NOTE: #= Not Mounted

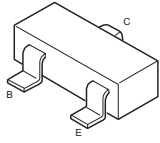
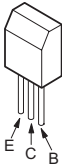
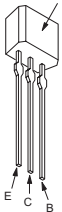
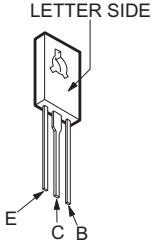
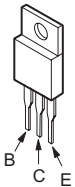
5-4. SEMICONDUCTORS

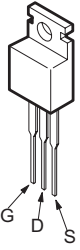
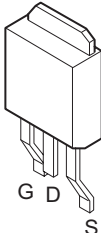
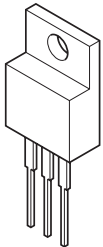
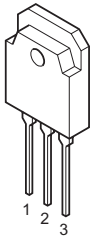
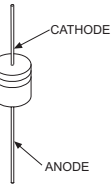
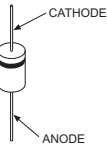
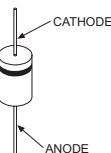
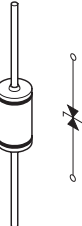
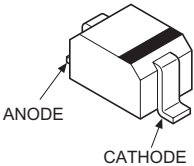
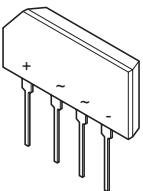
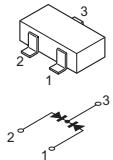
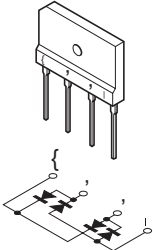
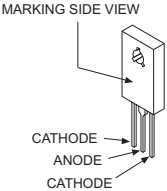
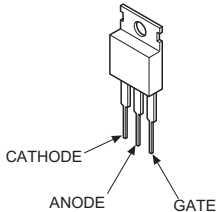
<p>2SB709A-QRS-TX 2SD601A-QRS-TX</p> 	<p>2SB734-T-34 2SC3209LK-TP</p> 	<p>2SA1309A-QRSTA 2SC3311A-QRSTA 2SD2144S-TP-UVV</p> 	<p>2SC3840K</p> <p>LETTER SIDE</p> 	<p>2SA1837</p> 
<p>2SA10910-TPE2</p> 	<p>IRF614</p> 	<p>2SK2663</p> 	<p>2SC4793</p> 	<p>2SD2578-YB</p> 
<p>ERA38-06TP1 ERA82-004TP5 1SS133T-77 D1NS0R-TA MTZJ-T-77-12C MTZJ-T-77-15B MTZJ-T-77-33B MTZJ-T-77-39</p> 	<p>RU-1P ERC06-15S EGP20DPKG23 MTZJ-T-77-5.1C MTZJ-T-77-5.6C MTZJ-T-77-7.5A MTZJ-T-77-10B MTZJ-T-77-30D RGP10-GPKG3 RGP02-17PKG23 RGP15GPKG23</p> 	<p>ERB44-06TP1 1SS83TD GP08DPKG23 RGP10GPKG23 RU4AM-T3</p> 	<p>RD9.1EW-T1</p> 	<p>MA111-TX UDZ-TE-17.5.1B UDZ-TE-17.91B</p> 
<p>D2SB60A-F04</p> 	<p>DAP202K-T-146</p> 	<p>D4SB60L-F</p> 		
<p>D5LC20U</p> <p>MARKING SIDE VIEW</p> 	<p>TF541M</p> 			

SECTION 6: EXPLODED VIEWS

Components not identified by a part number or description are not stocked because they are seldom required for routine service.

The component parts of an assembly are indicated by the reference numbers in the far right column of the parts list and within the dotted lines of the diagram.

* Items marked with an asterisk are not stocked since they are seldom required for routine service. Expect some delay when ordering these components.

NOTE: The components identified by shading and ⚠ mark are critical for safety. Replace only with part number specified.

NOTE: Les composants identifiés par un trame et une marque ⚠ sont critiques pour la sécurité. Ne les remplacer que par une pièce portant le numéro spécifié.

6-1. CHASSIS (KV-27FV17/29FV17/29FV17C ONLY)

- 7-685-648-91 SCREW +BVTP 3 x 12 TYPE 2 TTB
- 7-685-663-91 SCREW +BVTP 4X16 TYPE2 TTB

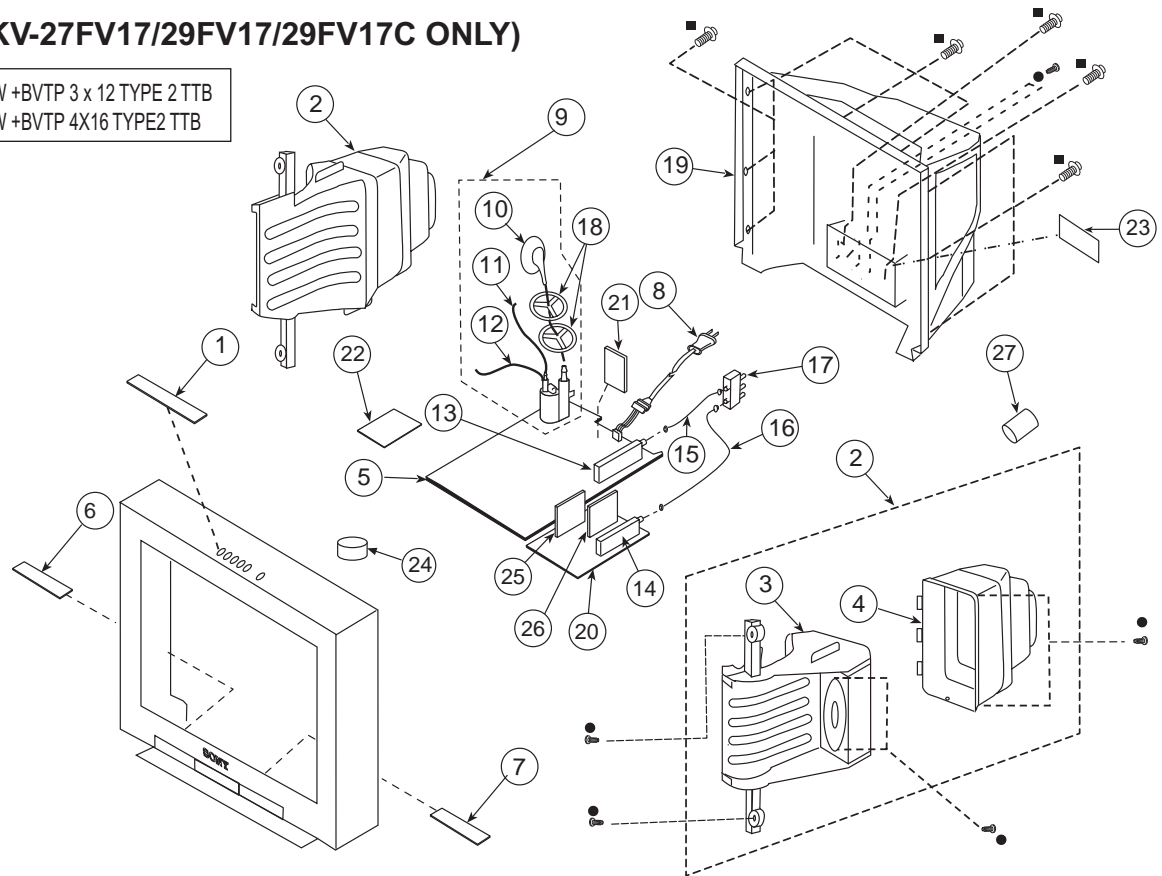

REF. NO.	PART NO.	DESCRIPTION	[Assembly Includes]	REF. NO.	PART NO.	DESCRIPTION
* 1	A-1372-817-A	HX MOUNTED PC BOARD		⚠ 12	1-900-803-22	G2 LEAD
* 2	1-544-780-11	SPEAKER, BOX TYPE (5.10CM)	[3-4]	⚠ 13	8-598-542-20	TUNER, FSS BTF-WA412
3	4-068-988-01	BAFFLE, SPEAKER		⚠ 14	8-598-501-30	TUNER, FSS BTF-FA402
* 4	4-068-987-01	COVER, SPEAKER		* 15	1-557-056-31	CABLE, P-P
* 5	A-1299-243-A	A COMPLETE PC BOARD (KV-27FV17 ONLY)		* 16	1-783-800-11	CABLE, PIN
5	A-1299-498-A	A COMPLETE PC BOARD (KV-29FV17 ONLY)		17	8-598-414-20	CHANGER, ANTENNA AS-2F
5	A-1299-244-A	A COMPLETE PC BOARD (KV-29FV17C ONLY)		18	3-704-372-71	HOLDER, HV CABLE
		The high-voltage leads associated with the FBT on this board are not included and must be ordered separately (See 10-12).		19	4-076-875-01	COVER, REAR
* 6	A-1372-825-A	HA MOUNTED PC BOARD				The labels associated with the rear cover are not included and must be ordered separately (See 23).
* 7	A-1372-826-A	HB (VAR) MOUNTED PC BOARD		* 20	A-1304-202-A	MA (VAR) MOUNTED PC BOARD
⚠ 8	1-769-796-31	CORD, POWER (WITH CONNECTOR) (KV-29FV17C ONLY)		* 21	A-1380-633-A	K (VAR) MOUNTED PC BOARD
⚠ 8	1-792-874-11	CORD, AC POWER(WITH CONNECTOR) (KV-27FV17/29FV17 ONLY)		* 22	A-1343-875-A	D (VAR) MOUNTED PC BOARD
⚠ 9	1-453-310-11	FBT ASSY NX-4521//X4J4	[10-12]	23	4-075-666-01	LABEL, 2-TUNER ANTENNA
⚠ 10	1-251-374-13	HV CAP ASSY		24	1-452-094-00	CIRCULAR DISC MAGNET B
⚠ 11	1-900-800-82	FOCUS LEAD		25	A-1190-391A	P MOUNTED PC BOARD
				* 26	A-1131-593-A	BC MOUNTED PC BOARD
				27	1-500-586-11	FILTER, CLAMP (FERRITE CORE) (KV-27FV17/29FV17 ONLY)

NOTE: The components identified by shading and ⚠ mark are critical for safety. Replace only with part number specified.

NOTE: Les composants identifiés par un trame et une marque ⚠ sont critiques pour la sécurité. Ne les remplacer que par une pièce portant le numéro spécifié.

6-2. PICTURE TUBE REMOVAL (KV-27FV17/29FV17/29FV17C ONLY)

▲ 4-046-765-12 SCREW, TAPPING 7+CROWN WASHER

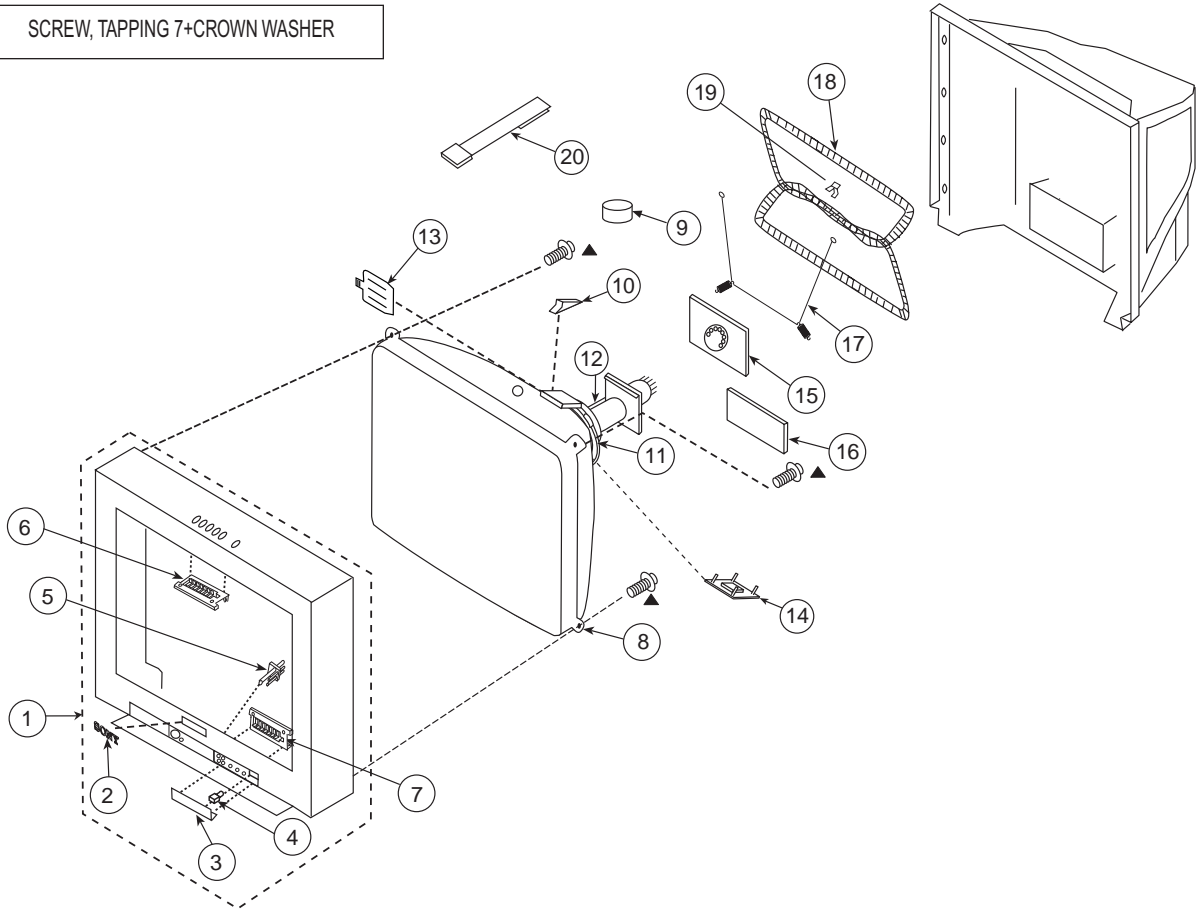

REF. NO.	PART NO.	DESCRIPTION	[Assembly Includes]	REF. NO.	PART NO.	DESCRIPTION
1	X-4038-944-1	BEZNET ASSY (KV-27FV17 ONLY)	[2-4]	*	15	A-1332-063-A CA (VAR) MOUNTED PC BOARD
1	X-4037-842-2	BEZNET ASSY (KV-29FV17/29FV17C ONLY)	[2-4]	*	16	A-1342-550-A VA (VAR) MOUNTED PC BOARD
2	3-704-179-31	EMBLEM (NO.9), SONY		17	4-036-329-01	SPRING (B), TENSION
3	X-4037-631-3	DOOR		⚠ 18	1-419-156-21	COIL, DEGAUSSING (KV-27FV17/29FV17 ONLY)
4	3-703-574-00	RETAINER, DOOR		⚠ 18	1-419-523-21	COIL, DEGAUSSING (KV-29FV17C ONLY)
5	4-068-986-11	GUIDE, LED		*	19	4-062-970-12 CLIP (29RSN), DGC
6	4-068-982-11	MULTI-BUTTON (TOP)		20	4-062-047-02	PIECE A(110), CONV CORRECT
7	4-068-984-01	MULTI-BUTTON (BOTTOM)				
⚠ 8	8-735-082-05	CRT 29RSN(SDP) (KV-27FV17/29FV17 ONLY)				
⚠ 8	8-735-083-05	CRT 29RSN(SDP)(SOUTH) (KV-29FV17C ONLY)				
9	1-452-032-00	MAGNET, DISC				
10	4-053-005-01	SPACER, DY				
⚠ 11	8-451-494-41	DY Y29RSA-V				
⚠ 12	8-453-011-11	NA299-M (NECK ASSEMBLY)				
13	4-081-170-01	PLATE, TLH CORRECTION				
14	1-452-896-11	COIL, NA ROTATION (RT200)				

NOTE: The components identified by shading and ⚠ mark are critical for safety. Replace only with part number specified.

NOTE: Les composants identifiés par un trame et une marque ⚠ sont critiques pour la sécurité. Ne les remplacer que par une pièce portant le numéro spécifié.

6-3. CHASSIS (KV-27FS13/27FS17 ONLY)

- 7-685-648-91 SCREW +BVTP 3 x 12 TYPE 2 TTB
- 7-685-663-91 SCREW +BVTP 4X16 TYPE2 TTB
- ▲ 4-388-477-02 SCREW (3X16) TAPPING, BV WASHER

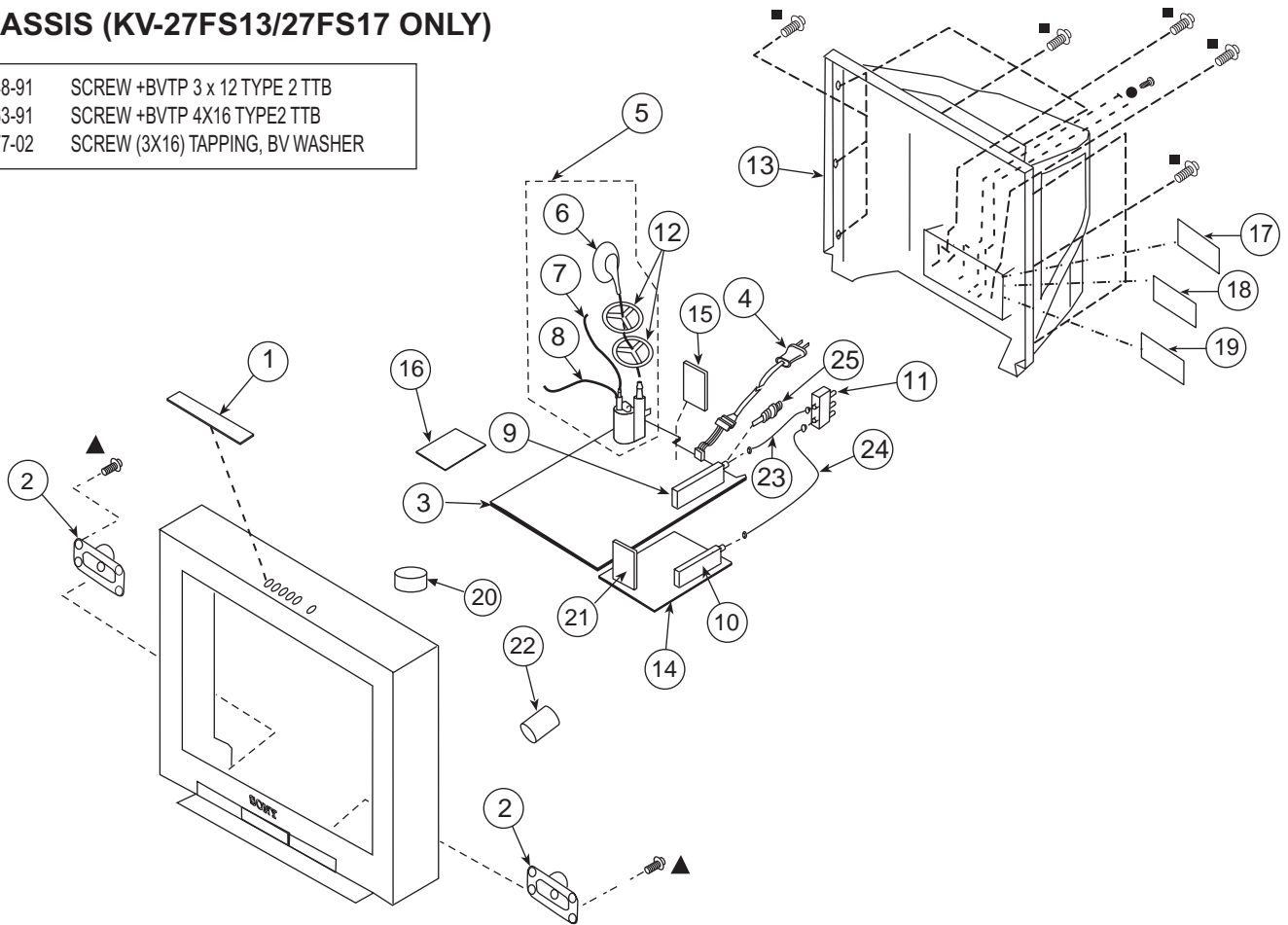

REF. NO.	PART NO.	DESCRIPTION	[Assembly Includes]	REF. NO.	PART NO.	DESCRIPTION
* 1	A-1372-817-A	HX MOUNTED PC BOARD		* 14	A-1304-198-A	MA (VAR) MOUNTED PC BOARD (KV-27FS17 ONLY)
2	1-529-638-11	SPEAKER (6X12CM)		* 15	A-1380-632-A	K (VAR) MOUNTED PC BOARD
* 3	A-1299-502-A	A COMPLETE PC BOARD (KV-27FS13 ONLY)		* 16	A-1343-875-A	D (VAR) MOUNTED PC BOARD
* 3	A-1299-503-A	A COMPLETE PC BOARD (KV-27FS17 ONLY)		17	4-075-666-01	LABEL, 2-TUNER ANTENNA (KV-27FS17 ONLY)
		The high-voltage leads associated with the FBT on this board are not included and must be ordered separately. (See 6-8.)		18	4-075-664-01	LABEL, 1-TUNER ANTENNA (KV-27FS13 ONLY)
⚠ 4	1-792-874-11	CORD, AC POWER (WITH CONNECTOR)		19	4-075-665-01	LABEL, TERMINAL
⚠ 5	1-453-310-11	FBT ASSY NX-4521//X4J4	[6-8]	20	1-452-094-00	CIRCULAR DISC MAGNET B
⚠ 6	1-251-374-13	HV CAP ASSY		* 21	A-1190-391-A	P MOUNTED PC BOARD (KV-27FS17 ONLY)
⚠ 7	1-900-800-82	FOCUS LEAD		22	1-500-586-11	FILTER, CLAMP (FERRITE CORE)
⚠ 8	1-900-803-22	G2 LEAD		23	1-557-056-31	CABLE, P-P (KV-27FS17 ONLY)
⚠ 9	8-598-542-20	TUNER, FSS BTF-WA412		24	1-783-800-11	CABLE, PIN (KV-27FS17 ONLY)
⚠ 10	8-598-501-30	TUNER, FSS BTF-FA402 (KV-27FS17 ONLY)		25	1-766-374-11	PLUG, F-PIN (KV-27FS13 ONLY)
11	8-598-414-20	CHANGER, ANTENNA AS-2F (KV-27FS17 ONLY)				
12	3-704-372-71	HOLDER, HV CABLE				
13	4-075-652-11	COVER, REAR				
		The labels associated with the rear cover are not included and must be ordered separately (See 17-19).				
* 14	A-1304-200-A	MA (VAR) MOUNTED PC BOARD (KV-27FS13 ONLY)				

NOTE: The components identified by shading and ⚠ mark are critical for safety. Replace only with part number specified.

NOTE: Les composants identifiés par un trame et une marque ⚠ sont critiques pour la sécurité. Ne les remplacer que par une pièce portant le numéro spécifié.

6-4. CHASSIS (KV-32FS13/32FS17/34FS13C/34FS17 ONLY)

- 7-685-648-91 SCREW +BVTP 3 x 12 TYPE 2 TTB
- 7-685-663-91 SCREW +BVTP 4X16 TYPE2 TTB
- ▲ 4-388-477-02 SCREW (3X16) TAPPING, BV WASHER

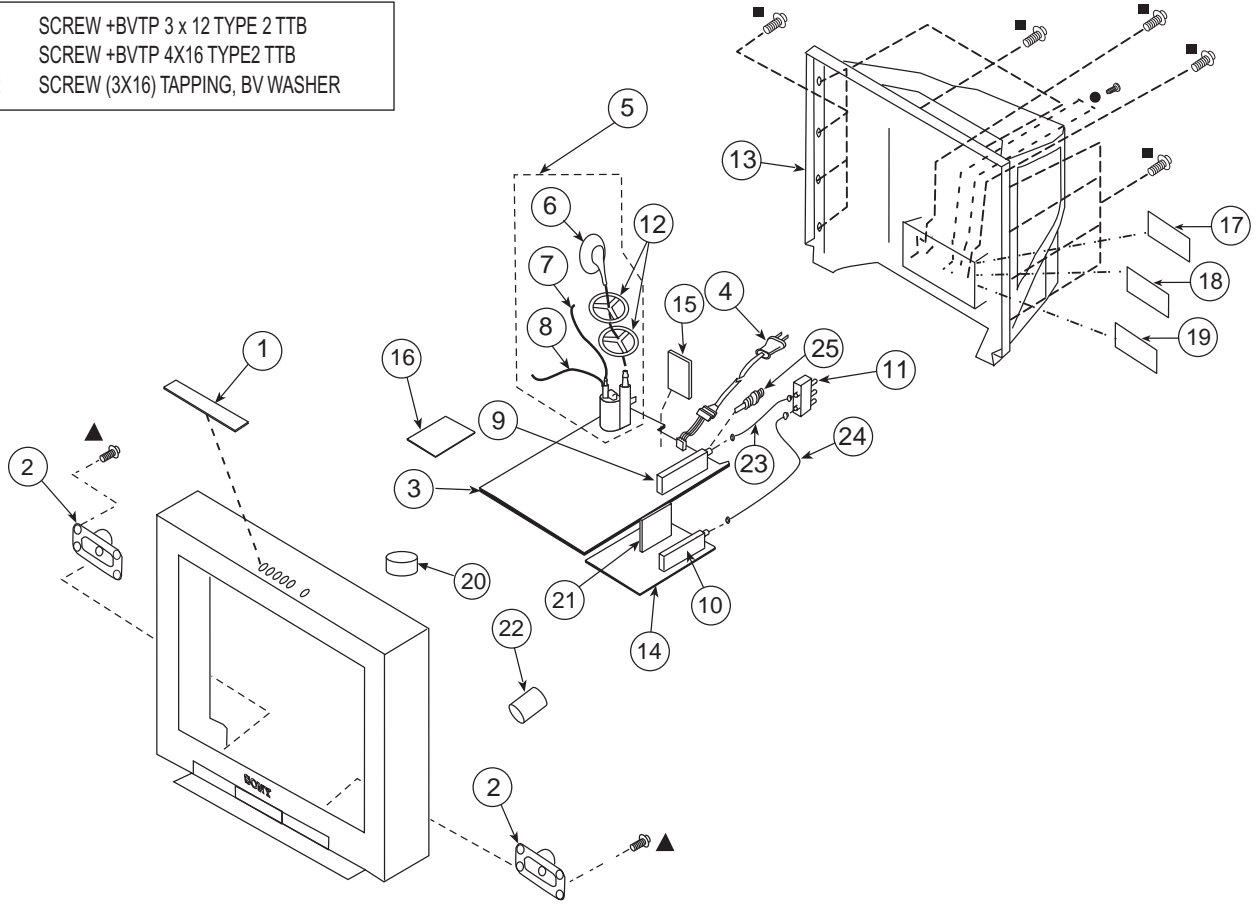

REF. NO.	PART NO.	DESCRIPTION	[Assembly Includes]	REF. NO.	PART NO.	DESCRIPTION
* 1	A-1372-817-A	HX MOUNTED PC BOARD		13	4-075-654-01	COVER, REAR
2	1-529-638-11	SPEAKER (6X12CM)		The labels associated with the rear cover are not included and must be ordered separately (See 17-19).		
* 3	A-1299-516-A	A COMPLETE PC BOARD (KV-32FS13 ONLY)		* 14	A-1304-196-A	MA (VAR) MOUNTED PC BOARD (KV-32FS17/34FS17 ONLY)
* 3	A-1299-504-A	A COMPLETE PC BOARD (KV-32FS17/34FS17 ONLY)		* 14	A-1304-203-A	MA (VAR) MOUNTED PC BOARD (KV-32FS13/34FS13C ONLY)
* 3	A-1299-506-A	A COMPLETE PC BOARD (KV-34FS13C ONLY)		* 15	A-1380-632-A	K (VAR) MOUNTED PC BOARD
The high-voltage leads associated with the FBT on this board are not included and must be ordered separately (See 6-8).				* 16	A-1343-874-A	D (VAR) MOUNTED PC BOARD
⚠ 4	1-792-874-11	CORD, AC POWER (WITH CONNECTOR) (KV-32FS13/32FS17/34FS17 ONLY)		17	4-075-666-01	LABEL, 2-TUNER ANTENNA (KV-32FS17/34FS17 ONLY)
⚠ 4	1-769-796-31	CORD, POWER (WITH CONNECTOR) (KV-34FS13C ONLY)		18	4-075-664-01	LABEL, 1-TUNER ANTENNA (KV-32FS13/34FS13C ONLY)
⚠ 5	1-453-338-11	FBT ASSY NX-4600//X4J4	[6-8]	19	4-075-665-01	LABEL, TERMINAL
⚠ 6	1-251-374-13	HV CAP ASSY		20	1-452-094-00	CIRCULAR DISC MAGNET B
⚠ 7	1-900-800-82	FOCUS LEAD		* 21	A-1190-391-A	P MOUNTED PC BOARD (KV-32FS17/34FS17 ONLY)
⚠ 8	1-900-803-50	G2 LEAD		22	1-500-586-11	FILTER, CLAMP (FERRITE CORE) (KV-32FS13/32FS17 ONLY)
⚠ 9	8-598-542-20	TUNER, FSS BTF-WA412		23	1-557-056-31	CABLE, P-P (KV-32FS17/34FS17 ONLY)
⚠ 10	8-598-501-30	TUNER, FSS BTF-FA402 (KV-32FS17/34FS17 ONLY)		24	1-783-800-11	CABLE, PIN (KV-32FS17/34FS17 ONLY)
11	8-598-414-20	CHANGER, ANTENNA AS-2F (KV-32FS17/34FS17 ONLY)		25	1-766-374-11	PLUG, F-PIN (KV-32FS13/34FS13C ONLY)
12	3-704-372-71	HOLDER, HV CABLE				

NOTE: The components identified by shading and ⚠ mark are critical for safety. Replace only with part number specified.

NOTE: Les composants identifiés par un trame et une marque ⚠ sont critiques pour la sécurité. Ne les remplacer que par une pièce portant le numéro spécifié.

6-5. PICTURE TUBE REMOVAL (KV-27FS13/27FS17/32FS13/32FS17/34FS13C/34FS17 ONLY)

▲ 4-046-765-12 SCREW, TAPPING 7+CROWN WASHER

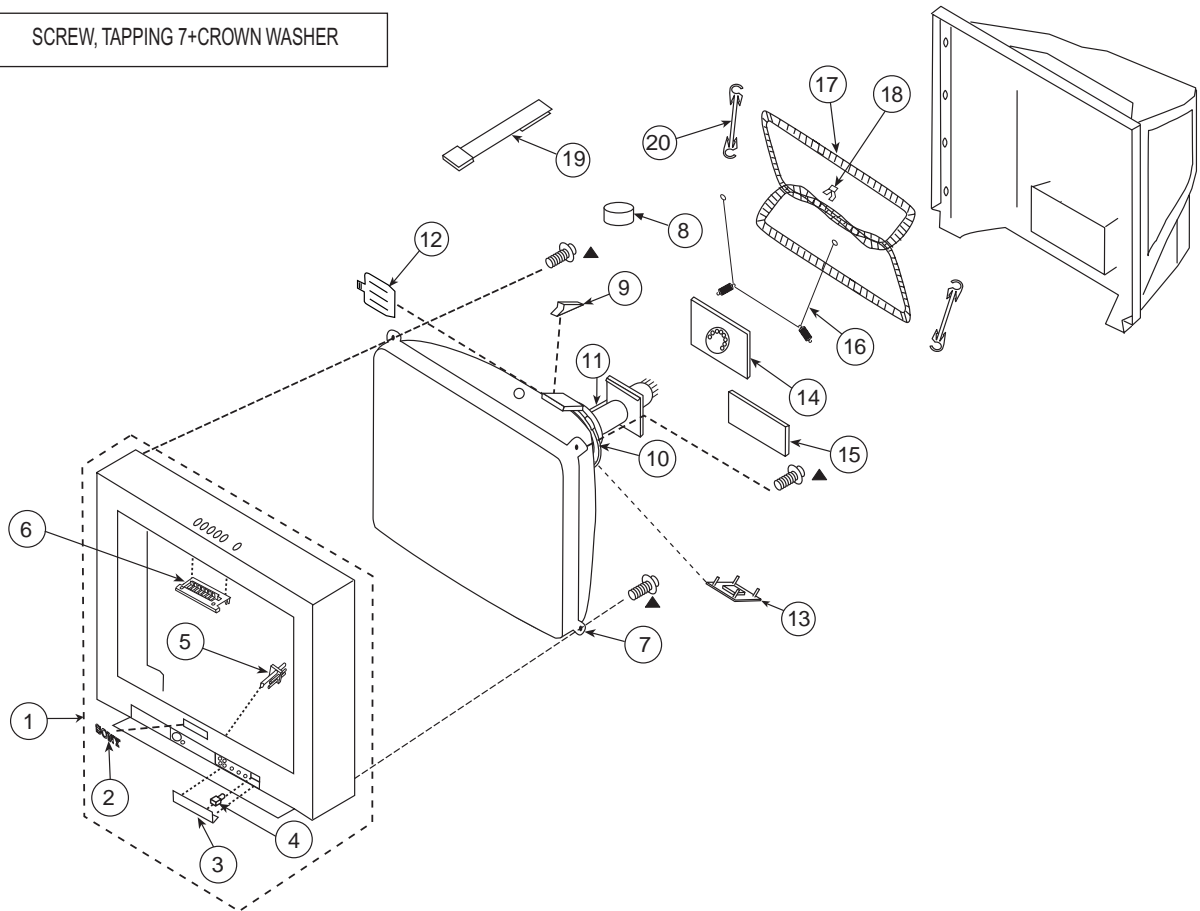

REF. NO.	PART NO.	DESCRIPTION	[Assembly Includes]	REF. NO.	PART NO.	DESCRIPTION
1	X-4038-955-1	BEZNET ASSY (KV-27FS13/27FS17 ONLY)	[2-5]	⚠ 11	8-453-011-11	NA299-M (NECK ASSEMBLY) (KV-27FS13/27FS17 ONLY)
1	X-4039-003-1	BEZNET ASSY (KV-32FS13/32FS17 ONLY)	[2-5]	⚠ 11	8-453-007-41	NA324-M4 (NECK ASSEMBLY) (KV-32FS13/32FS17/34FS13C/34FS17 ONLY)
1	X-4037-664-3	BEZNET ASSY (KV-34FS13/34FS17 ONLY)	[2-5]	12	4-081-170-01	PLATE, TLH CORRECTION
2	3-704-179-31	EMBLEM (NO.9), SONY		13	1-452-896-11	COIL, NA ROTATION (RT200)
3	4-075-658-21	DOOR (KV-34FS13C/34FS17 ONLY)		* 14	A-1332-063-A	CA (VAR) MOUNTED PC BOARD (KV-27FS13/27FS17 ONLY)
3	4-075-658-31	DOOR (KV-27FS13/27FS17/32FS13/32FS17 ONLY)		* 14	A-1332-061-A	CA (VAR) MOUNTED PC BOARD (KV-32FS13/32FS17/34FS13C/34FS17 ONLY)
4	4-047-464-01	CATCHER, PUSH		* 15	A-1342-550-A	VA (VAR) MOUNTED PC BOARD (KV-27FS13/27FS17 ONLY)
5	4-075-657-01	GUIDE, LED		* 15	A-1342-549-A	VA (VAR) MOUNTED PC BOARD (KV-32FS13/32FS17/34FS13C/34FS17 ONLY)
6	4-068-982-11	MULTI-BUTTON (TOP)		16	4-036-329-01	SPRING (B), TENSION
⚠ 7	8-735-082-05	CRT 29RSN(SDP) (KV-27FS13/27FS17 ONLY)		⚠ 17	1-419-156-21	COIL, DEGAUSSING (KV-27FS13/27FS17 ONLY)
⚠ 7	8-735-066-05	CRT 34RSN(SDP) (KV-32FS13/32FS17/34FS17 ONLY)		⚠ 17	1-416-827-21	COIL, DEGAUSSING (KV-32FS13/32FS17/34FS17 ONLY)
⚠ 7	8-735-084-05	CRT 34RSN(SDP)(SOUTH) (KV-34FS13C ONLY)		⚠ 17	1-416-866-11	COIL, DEGAUSSING (KV-34FS13C ONLY)
8	1-452-032-00	MAGNET,DISC		* 18	4-062-970-12	CLIP (29RSN), DGC (KV-27FS13/27FS17 ONLY)
9	4-053-005-01	SPACER, DY		19	4-062-047-02	PIECE A(110), CONV CORRECT
⚠ 10	8-451-494-41	DY Y29RSA-V (KV-27FS13/27FS17 ONLY)		20	4-065-895-11	HOLDER, DGC (KV-32FS13/32FS17/34FS13C/34FS17 ONLY)
⚠ 10	8-451-499-41	DY Y34RSA-V (KV-32FS13/32FS17/34FS13C/34FS17 ONLY)				

SECTION 7: ELECTRICAL PARTS LIST

PARTS LISTING TABLE OF CONTENTS

A BOARD <u>COMMON</u> PARTS LISTING FS SERIES: Parts common to all FS series models	62
A BOARD <u>COMMON</u> PARTS LISTING FV SERIES: Parts common to all FV series models	68
A BOARD <u>VARIANTS</u> PARTS LISTING - Parts that belong only to the model specified:	74

Refer to the designated variant parts list when seeking a part indicated by an asterick (*) on the A Board Schematic or by the phrase "VARIANT (SEE VARIANT PARTS LIST)" on the Common Parts Listing

<u>Model</u>	<u>Page</u>
KV-27FS13	74
KV-27FS17	75
KV-32FS13	76
KV-32FS17/34FS17	77
KV-34FS13C	78
KV-27FV17	79
KV-29FV17	80
KV-29FV17C	81

MA BOARD <u>COMMON</u> PARTS LISTING FS SERIES: Parts common to all FS series models	82
MA BOARD <u>VARIANTS</u> PARTS LISTING: Parts that belong only to the model specified:	87

Refer to the designated variant parts list when seeking a part indicated by an asterick (*) on the MA Board Schematic or by the phrase "VARIANT (SEE VARIANT PARTS LIST)" on the Common Parts Listing

<u>Model</u>	<u>Page</u>
KV-27FS13	87
KV-27FS17	88
KV-32FS13/34FS13C	89
KV-32FS17/34FS17	90

MA BOARD <u>COMPLETE</u> PARTS LISTING FV SERIES: (KV-27FV17/29FV17/29FV17C ONLY)	91
BC BOARD <u>COMPLETE</u> PARTS LISTING: (KV-27FV17/29FV17/29FV17C ONLY)	95
P BOARD <u>COMPLETE</u> PARTS LISTING: (KV-27FS17/27FV17/29FV17/29FV17C/32FS17/34FS17 ONLY)	97
CA BOARD <u>COMPLETE</u> PARTS LISTING: (ALL MODELS)	98
VA BOARD <u>COMPLETE</u> PARTS LISTING: (ALL MODELS)	99
D BOARD <u>COMPLETE</u> PARTS LISTING: (ALL MODELS)	99
HX BOARD <u>COMPLETE</u> PARTS LISTING: (ALL MODELS)	101
HA BOARD <u>COMPLETE</u> PARTS LISTING: (KV-27FV17/29FV17/29FV17C ONLY)	102
HB BOARD <u>COMPLETE</u> PARTS LISTING: (KV-27FV17/29FV17/29FV17C ONLY)	102
K BOARD <u>COMPLETE</u> PARTS LISTING: (ALL MODELS):	102
ACCESSORIES AND PACKAGING MATERIAL:	104
REMOTE COMMANDER:	104

COMMON PARTS LISTING FS SERIES



NOTE: The components identified by shading and \triangle mark are critical for safety. Replace only with part number specified.

NOTE: Les composants identifiés par un trame et une marque \triangle sont critiques pour la sécurité. Ne les remplacer que par une pièce portant le numéro spécifié.

The components in this manual identified by the following symbol: \boxtimes indicate parts that have been carefully factory-selected to satisfy regulations regarding X-ray radiation for each set.

Should replacement be required for one of these components, replace only with the value originally used.

* Items marked with an asterisk are not stocked since they are seldom required for routine service. Expect some delay when ordering these components.

RESISTORS

- All resistors are in ohms
- F : nonflammable
- All variable and adjustable resistors have characteristic curve B, unless otherwise noted.

When ordering parts by reference number, please include the board name.

REF. NO.	PART NO.	DESCRIPTION	VALUES	REF. NO.	PART NO.	DESCRIPTION	VALUES
A BOARD COMMON PARTS LISTING FS SERIES							
		A					
*	A-1299-502-A	A COMPLETE PC BOARD (KV-27FS13 ONLY)		C219	1-126-964-11	ELECT	10 μ F 20% 50V
*	A-1299-503-A	A COMPLETE PC BOARD (KV-27FS17 ONLY)		C401	1-126-968-11	ELECT	100 μ F 20% 50V
*	A-1299-516-A	A COMPLETE PC BOARD (KV-32FS13 ONLY)		C402	1-126-943-11	ELECT	2200 μ F 20% 25V
*	A-1299-504-A	A COMPLETE PC BOARD (KV-32FS17/34FS17 ONLY)		C403	1-126-957-11	ELECT	0.22 μ F 20% 50V
*	A-1299-506-A	A COMPLETE PC BOARD (KV-34FS13C ONLY)		C420	1-164-222-91	CERAMIC	0.22 μ F 25V
		The high-voltage leads associated with the FBT on the A board are not included and must be ordered separately. Order the following leads when requesting this A board:		C421	1-216-295-91	SHORT	
\triangle	1-251-374-13	HV CAP ASSY		C435	1-164-222-91	CERAMIC	0.22 μ F 25V
\triangle	1-900-800-82	FOCUS LEAD		C441	1-164-346-11	CERAMIC	1 μ F 16V
\triangle	1-900-803-22	G2 LEAD (KV-27FS13/ 27FS17 ONLY)		C442	1-126-963-11	ELECT	4.7 μ F 20% 50V
\triangle	1-900-803-50	G2 LEAD (KV-32FS13/32FS17/34FS17/ 34FS13C ONLY)		C496	1-216-295-91	SHORT	
*	1-508-784-21	PIN, CONNECTOR (5MM PITCH) 1P		C501	1-102-114-00	CERAMIC	470pF 10% 50V
	1-533-223-11	HOLDER, FUSE		C502	1-106-383-00	MYLAR	0.047 μ F 10% 200V
*	4-374-846-11	COVER, CAPACITOR, CAP TYPE		C503	1-102-228-00	CERAMIC	470pF 10% 500V
	4-382-854-11	SCREW (M3X10), P, SW (+)		C504	1-102-228-00	CERAMIC	470pF 10% 500V
	CAPACITOR			\triangle C505	1-162-116-00	CERAMIC	680pF 10% 2KV
C100	1-216-295-91	SHORT		C506	1-162-318-11	CERAMIC	0.001 μ F 10% 500V
C101	1-216-295-91	SHORT		C507		VARIANT (SEE VARIANT PARTS LIST)	
C102	1-126-933-11	ELECT	100 μ F 20% 16V	\triangle C508	1-137-150-11	MYLAR	0.01 μ F 10% 100V
C104	1-126-941-11	ELECT	470 μ F 20% 25V	\triangle C509	1-162-116-00	CERAMIC	680pF 10% 2KV
C105	1-104-664-11	ELECT	47 μ F 20% 25V	C510	1-107-649-11	ELECT	2.2 μ F 20% 250V
C204	1-163-017-00	CERAMIC	0.0047 μ F 10% 50V	C511		VARIANT (SEE VARIANT PARTS LIST)	
C205	1-126-963-11	ELECT	4.7 μ F 20% 50V	\triangle C512	1-106-387-00	MYLAR	0.068 μ F 10% 200V
C207	1-126-961-11	ELECT	2.2 μ F 20% 50V	C513	1-104-987-11	MYLAR	0.001 μ F 10% 100V
C208	1-126-961-11	ELECT	2.2 μ F 20% 50V	C514		VARIANT (SEE VARIANT PARTS LIST)	
C210	1-126-963-11	ELECT	4.7 μ F 20% 50V	\triangle C515	1-162-116-00	CERAMIC	680pF 10% 2KV
C214	1-164-346-11	CERAMIC	1 μ F 16V	C517		VARIANT (SEE VARIANT PARTS LIST)	
C215	1-164-346-11	CERAMIC	1 μ F 16V	C520		VARIANT (SEE VARIANT PARTS LIST)	
C216	1-126-963-11	ELECT	4.7 μ F 20% 50V	C521	1-164-646-11	CERAMIC	2200pF 10% 500V
				C523	1-126-941-11	ELECT	470 μ F 20% 25V
				C524	1-102-244-00	CERAMIC	220pF 10% 500V
				C525	1-107-612-11	CERAMIC	100pF 5% 500V
				C526	1-126-960-11	ELECT	1 μ F 20% 50V
				C527	1-126-965-91	ELECT	22 μ F 20% 50V
				C528	1-164-161-11	CERAMIC	0.0022 μ F 10% 50V
				C529	1-164-161-11	CERAMIC	0.0022 μ F 10% 50V
				C530		VARIANT (SEE VARIANT PARTS LIST)	
				C531	1-106-387-00	MYLAR	0.068 μ F 10% 200V
				C533	1-126-941-11	ELECT	470 μ F 20% 25V

NOTE: The components identified by shading and \triangle mark are critical for safety. Replace only with part number specified.

NOTE: Les composants identifiés par un trame et une marque \triangle sont critiques pour la sécurité. Ne les remplacer que par une pièce portant le numéro spécifique.



COMMON PARTS LISTING FS SERIES

REF. NO.	PART NO.	DESCRIPTION	VALUES			REF. NO.	PART NO.	DESCRIPTION	VALUES		
\triangle C534	1-126-964-11	ELECT	10 μ F	20%	50V	C636	1-126-970-11	ELECT	330 μ F	20%	50V
C535	1-126-959-11	ELECT	0.47 μ F	20%	50V	C637	1-163-009-91	CERAMIC	0.001 μ F	10%	50V
C536	1-102-228-00	CERAMIC	470pF	10%	500V	C638	1-163-005-91	CERAMIC	470pF	10%	50V
\triangle C537	1-126-965-91	ELECT	22 μ F	20%	50V	C639	1-126-965-91	ELECT	22 μ F	20%	50V
C539	1-107-662-11	ELECT	22 μ F	20%	250V	C641	1-107-679-91	ELECT	10 μ F	20%	450V
C540	1-107-645-11	ELECT	22 μ F	20%	160V	C643	1-104-760-11	CERAMIC	0.047 μ F	10%	50V
C541	1-126-969-11	ELECT	220 μ F	20%	50V	C647	1-161-964-91	CERAMIC	0.0047 μ F		250V
C542	1-126-967-11	ELECT	47 μ F	20%	50V	C648	1-136-346-21	MYLAR	0.22 μ F	20%	125V
C543	1-136-169-00	FILM	0.22 μ F	5%	50V	C652	1-130-471-00	MYLAR	0.001 μ F	5%	50V
\triangle C546	1-126-965-91	ELECT	22 μ F	20%	50V	C654	1-107-636-11	ELECT	10 μ F	20%	160V
\triangle C547	1-163-031-91	CERAMIC	0.01 μ F		50V	\triangle C655	1-136-311-11	MYLAR	0.47 μ F	20%	125V
C548		VARIANT (SEE VARIANT PARTS LIST)				C657	1-104-664-11	ELECT	47 μ F	20%	25V
C549	1-126-934-11	ELECT	220 μ F	20%	16V	C658		VARIANT (SEE VARIANT PARTS LIST)			
C550		VARIANT (SEE VARIANT PARTS LIST)				C659	1-135-573-51	ELECT	15000 μ F	20%	25V
\triangle C551	1-137-417-11	MYLAR	0.0047 μ F	10%	200V	C660		VARIANT (SEE VARIANT PARTS LIST)			
C553	1-107-662-11	ELECT	22 μ F	20%	250V	C661		VARIANT (SEE VARIANT PARTS LIST)			
C554	1-102-110-00	CERAMIC	220pF	10%	50V	C2001	1-104-664-11	ELECT	47 μ F	20%	25V
C555		VARIANT (SEE VARIANT PARTS LIST)				CONNECTOR					
C601	1-164-004-11	CERAMIC	0.1 μ F	10%	25V	* CN301	1-564-507-11	PLUG,CONNECTOR 4P			
C602	1-126-967-11	ELECT	47 μ F	20%	50V	* CN406	1-564-507-11	PLUG,CONNECTOR 4P			
C604	1-164-182-11	CERAMIC	0.0033 μ F	10%	50V	CN460	1-573-298-21	CONNECTOR, BOARD TO BOARD 20P			
\triangle C606	1-127-793-51	CERAMIC	2200pF	20%	250V	* CN501	1-580-798-11	CONNECTOR PIN (DY) 6P			
C607		VARIANT (SEE VARIANT PARTS LIST)				CN502	1-564-509-11	PLUG,CONNECTOR 6P			
C609	1-126-968-11	ELECT	100 μ F	20%	50V	* CN504	1-508-784-21	PIN,CONNECTOR (5MM PITCH) 1P			
C610	1-126-964-11	ELECT	10 μ F	20%	50V	* CN506	1-564-508-11	PLUG,CONNECTOR 5P			
\triangle C611	1-164-182-11	CERAMIC	2200pF	20%	250V	* CN515	1-564-510-11	PLUG,CONNECTOR 7P			
C612		VARIANT (SEE VARIANT PARTS LIST)				CN602	1-580-843-11	PIN,CONNECTOR (POWER)			
C613	1-126-964-11	ELECT	10 μ F	20%	50V	* CN603	1-573-963-11	PIN,CONNECTOR (PC BOARD) 3P			
C614	1-130-495-00	MYLAR	0.1 μ F	5%	50V	* CN604		VARIANT (SEE VARIANT PARTS LIST)			
C615		VARIANT (SEE VARIANT PARTS LIST)				* CN2001	1-564-511-11	PLUG,CONNECTOR 8P			
C616		VARIANT (SEE VARIANT PARTS LIST)				* CN2003	1-564-506-11	PLUG,CONNECTOR 3P			
C617	1-125-893-11	FILM	680pF	3%	1.5KV	* CN2005	1-764-333-11	PLUG,CONNECTOR 10P			
C618	1-164-081-11	CERAMIC	470pF	10%	50V	* CN2006	1-764-333-11	PLUG,CONNECTOR 10P			
C619	1-136-356-11	MYLAR	470pF	5%	50V	* CN2007	1-564-512-11	PLUG,CONNECTOR 9P			
C620	1-104-665-11	ELECT	100 μ F	20%	25V	* CN2008	1-564-512-11	PLUG,CONNECTOR 9P			
C621	1-125-772-91	CERAMIC	1500pF	10%	2KV	DIODE					
C622	1-164-625-11	CERAMIC	680pF	10%	500V	D201	8-719-108-12	DIODE RD9.1EW-T1			
C623	1-164-625-11	CERAMIC	680pF	10%	500V	D203	8-719-108-12	DIODE RD9.1EW-T1			
C624	1-131-867-51	ELECT	100 μ F		160V	D204	8-719-982-22	DIODE MTZJ-T-77-30D			
C625		VARIANT (SEE VARIANT PARTS LIST)				D205	8-719-108-12	DIODE RD9.1EW-T1			
C626	1-135-573-51	ELECT	15000 μ F	20%	25V	D206	8-719-108-12	DIODE RD9.1EW-T1			
C627	1-136-189-00	MYLAR	0.1 μ F	10%	250V	D208	8-719-108-12	DIODE RD9.1EW-T1			
C628	1-104-665-11	ELECT	100 μ F	20%	25V	D209	8-719-069-60	DIODE UDZSTE-179.1B			
C630		VARIANT (SEE VARIANT PARTS LIST)				D210	8-719-110-17	DIODE MTZJ-T-77-10B			
C631		VARIANT (SEE VARIANT PARTS LIST)				D211	8-719-108-12	DIODE RD9.1EW-T1			
C634	1-137-605-11	MYLAR	0.01 μ F	10%	250V	D212	8-719-110-17	DIODE MTZJ-T-77-10B			
C635	1-163-009-91	CERAMIC	0.001 μ F	10%	50V	D213	8-719-110-17	DIODE MTZJ-T-77-10B			

NOTE: The components identified by shading and \triangle mark are critical for safety. Replace only with part number specified.

NOTE: Les composants identifiés par un trame et une marque \triangle sont critiques pour la sécurité. Ne les remplacer que par une pièce portant le numéro spécifique.



COMMON PARTS LISTING FS SERIES

REF. NO.	PART NO.	DESCRIPTION	VALUES	REF. NO.	PART NO.	DESCRIPTION	VALUES
D214	8-719-108-12	DIODE RD9.1EW-T1		D620	8-719-510-37	DIODE D5LC20U	
D215	8-719-108-12	DIODE RD9.1EW-T1		D622	8-719-077-76	DIODE D2SB60A-F04	
D230	8-719-108-12	DIODE RD9.1EW-T1		D623	8-719-081-70	DIODE BA159DGPPKG3	
D231	8-719-108-12	DIODE RD9.1EW-T1		D624	8-719-991-33	DIODE 1SS133T-77	
D232	8-719-108-12	DIODE RD9.1EW-T1		D625	8-719-991-33	DIODE 1SS133T-77	
D233	8-719-108-12	DIODE RD9.1EW-T1		D626	8-719-046-74	DIODE 10ELS2N-TA1B2	
D401	8-719-110-17	DIODE MTZJ-T-77-10B		D627	8-719-110-03	DIODE MTZJ-T-77-7.5A	
\triangle D501	8-719-945-80	DIODE ERC06-15S		D628	8-719-510-48	DIODE D1N20R-TA	
D502	8-719-908-03	DIODE GP08DPKG23		D2001	8-719-070-80	DIODE LNK0120022G	
D503	8-719-908-03	DIODE GP08DPKG23		D2002	8-719-110-17	DIODE MTZJ-T-77-10B	
\triangle D504	8-719-945-80	DIODE ERC06-15S		D2003	8-719-108-12	DIODE RD9.1EW-T1	
D505	8-719-312-10	DIODE RU4AM-T3		D2004	8-719-921-44	DIODE MTZJ-T-77-5.1C	
D506	8-719-302-43	DIODE RGP10GPKG3		D2005	8-719-921-44	DIODE MTZJ-T-77-5.1C	
D507	8-719-991-33	DIODE 1SS133T-77		FUSE			
D508	8-719-991-33	DIODE 1SS133T-77		\triangle F601	1-576-193-11	FUSE 6.3A/125V	
D509	8-719-109-89	DIODE MTZJ-T-77-5.6C		FERRITE BEAD			
D510	8-719-908-03	DIODE GP08DPKG23		FB501	1-410-397-21	FERRITE	1.1 μ H
D511	8-719-302-43	DIODE RGP10GPKG23		FB502	1-410-397-21	FERRITE	1.1 μ H
D512	8-719-404-50	DIODE MA111-TX		FB503	1-410-397-21	FERRITE	1.1 μ H
D513	8-719-979-85	DIODE RGP15GPKG23		FB600	1-412-911-11	FERRITE	0 μ H
D514	8-719-979-85	DIODE RGP15GPKG23		FB601	1-412-911-11	FERRITE	0 μ H
D515	8-719-404-50	DIODE MA111-TX		FB602	1-412-911-11	FERRITE	0 μ H
\triangle D516	8-719-991-33	DIODE 1SS133T-77		FB603	1-412-911-11	FERRITE	0 μ H
\triangle D517	8-719-991-33	DIODE 1SS133T-77		FB604	1-412-911-11	FERRITE	0 μ H
\triangle D518	8-719-921-63	DIODE MTZJ-T-77-7.5X		FB605		VARIANT (SEE VARIANT PARTS LIST)	
\triangle D519	8-719-979-84	DIODE EGP20DPKG23		FB606	1-412-911-11	FERRITE	0 μ H
\triangle D520	8-719-404-50	DIODE MA111-TX		FB607		VARIANT (SEE VARIANT PARTS LIST)	
D521	8-719-991-33	DIODE 1SS133T-77		FB608		VARIANT (SEE VARIANT PARTS LIST)	
D522	8-719-404-50	DIODE MA111-TX		FB609	1-412-911-11	FERRITE	0 μ H
D601	8-719-991-33	DIODE 1SS133T-77		FB610	1-412-911-11	FERRITE	0 μ H
D602	8-719-991-33	DIODE 1SS133T-77		IC			
D603	8-719-982-26	DIODE MTZJ-T-77-33B		\triangle IC402	8-759-573-40	IC TDA8580Q/N1	
D604	8-719-028-72	DIODE RGP02-17PKG23		\triangle IC501	8-759-700-07	IC NJM2903M-TE2	
\triangle D605	8-719-510-53	DIODE D4SB60L-F		IC502		VARIANT (SEE VARIANT PARTS LIST)	
\triangle D606	8-719-108-18	DIODE TF541M		IC601		VARIANT (SEE VARIANT PARTS LIST)	
D607	8-719-991-33	DIODE 1SS133T-77		\triangle IC602	8-749-016-47	IC EA135-F12	
D608	8-719-110-53	DIODE MTZJ-T-77-20B		IC603	8-759-653-07	IC PQ09RD21	
D609		VARIANT (SEE VARIANT PARTS LIST)		IC604	8-759-924-12	IC LM7805CT	
D610	8-719-210-21	DIODE 11EQS04-NTA1B		IC2001	8-742-212-20	HYB IC SBX3081-71	
D611	8-719-046-74	DIODE 10ELS2N-TA1B2		JACK			
D612	8-719-110-17	DIODE MTZJ-T-77-10B		J201	1-794-119-11	TERMINAL BLOCK, S 4P	
D613	8-719-046-74	DIODE 10ELS2N-TA1B2		J202	1-794-267-11	JACK, PIN 3P	
D614	8-719-046-74	DIODE 10ELS2N-TA1B2		J203	1-794-118-11	JACK BLOCK, PIN 3P	
D615	8-719-312-10	DIODE RU4AM-T3		J205	1-794-116-11	JACK BLOCK, PIN 2P	
D616	8-719-510-37	DIODE D5LC20U					
D617	8-719-110-31	DIODE MTZJ-T-77-12C					
D618	8-719-991-33	DIODE 1SS133T-77					
D619	8-719-110-17	DIODE MTZJ-T-77-10B					

NOTE: The components identified by shading and \triangle mark are critical for safety. Replace only with part number specified.

NOTE: Les composants identifiés par un trame et une marque \triangle sont critiques pour la sécurité. Ne les remplacer que par une pièce portant le numéro spécifique.



COMMON PARTS LISTING FS SERIES

































REF. NO.	PART NO.	DESCRIPTION	VALUES			REF. NO.	PART NO.	DESCRIPTION	VALUES		
J206	1-794-117-11	JACK BLOCK, PIN 3P				Q502		VARIANT (SEE VARIANT PARTS LIST)			
J402	1-794-116-11	JACK BLOCK, PIN 2P				\triangle Q503	8-729-422-27	TRANSISTOR 2SD601A-QRS-TX			
CHIP CONDUCTOR						\triangle Q504	8-729-053-87	TRANSISTOR KTC4370A			
JR001	1-216-295-91	SHORT				\triangle Q505	8-729-200-17	TRANSISTOR 2SA10910-TPE2			
JR002	1-216-295-91	SHORT				\triangle Q506	8-729-422-27	TRANSISTOR 2SD601A-QRS-TX			
JR402	1-216-295-91	SHORT				\triangle Q507	8-729-424-02	TRANSISTOR 2SB709A-QRS-TX			
JR403	1-216-295-91	SHORT				Q601	8-729-922-37	TRANSISTOR 2SD2144S-TP-UVV			
JR404	1-216-295-91	SHORT				Q602	8-729-423-33	TRANSISTOR 2SC3311A-QRSTA			
JR405	1-216-295-91	SHORT				\triangle Q603	8-729-119-76	TRANSISTOR 2SA1309A-QRSTA			
JR410	1-216-295-91	SHORT				Q604	8-729-422-27	TRANSISTOR 2SD601A-QRS-TX			
JR411	1-216-295-91	SHORT				\triangle Q605	8-729-046-40	TRANSISTOR 2SK2663			
JR471	1-164-222-91	CERAMIC	0.22 μ F	25V		Q606	8-729-422-27	TRANSISTOR 2SD601A-QRS-TX			
JR472	1-216-295-91	SHORT				Q607	8-729-922-37	TRANSISTOR 2SD2144S-TP-UVV			
JR501	1-216-295-91	SHORT				Q608	8-729-422-27	TRANSISTOR 2SD601A-QRS-TX			
JR502	1-216-295-91	SHORT				Q609	8-729-423-33	TRANSISTOR 2SC3311A-QRSTA			
JR503	1-216-295-91	SHORT				RESISTOR					
JR505	1-216-295-91	SHORT				R105	1-208-798-11	METAL	4.7K	0.50%	1/10W
JR522	1-216-295-91	SHORT				R107	1-216-025-11	RES-CHIP	100	5%	1/10W
JR523	1-216-295-91	SHORT				R108	1-216-025-11	RES-CHIP	100	5%	1/10W
JR526	1-216-295-91	SHORT				R115	1-216-295-91	SHORT			
JR527	1-216-295-91	SHORT				R201	1-216-113-00	RES-CHIP	470K	5%	1/10W
JR2003	1-216-295-91	SHORT				R202	1-216-113-00	RES-CHIP	470K	5%	1/10W
COIL						R203	1-216-022-00	RES-CHIP	75	5%	1/10W
L101	1-412-029-11	INDUCTOR	10 μ H			R204	1-216-081-00	RES-CHIP	22K	5%	1/10W
L102	1-412-032-11	INDUCTOR	100 μ H			R205	1-216-085-91	RES-CHIP	33K	5%	1/10W
L103	1-412-029-11	INDUCTOR	10 μ H			R208	1-215-924-00	METAL	15K	5%	3W
L501	1-409-955-11	INDUCTOR	8mH			R210	1-216-022-00	RES-CHIP	75	5%	1/10W
L502	1-412-552-11	INDUCTOR	2.2mH			R214	1-216-113-00	RES-CHIP	470K	5%	1/10W
L503	1-406-677-11	INDUCTOR	10mH			R215	1-216-113-00	RES-CHIP	470K	5%	1/10W
L504	1-412-533-21	INDUCTOR	47 μ H			R235	1-216-113-00	RES-CHIP	470K	5%	1/10W
L505		VARIANT (SEE VARIANT PARTS LIST)				R237	1-216-033-00	RES-CHIP	220	5%	1/10W
L506	1-406-677-11	INDUCTOR	10mH			R238	1-216-033-00	RES-CHIP	220	5%	1/10W
L507	1-412-552-11	INDUCTOR	2.2mH			R239	1-216-113-00	RES-CHIP	470K	5%	1/10W
\triangle L510	1-412-528-11	INDUCTOR	18 μ H			R401	1-216-080-00	RES-CHIP	20K	5%	1/10W
L603	1-412-529-11	INDUCTOR	22 μ H			R402	1-216-073-91	RES-CHIP	10K	5%	1/10W
L604	1-412-525-31	INDUCTOR	10 μ H			R411	1-249-417-11	CARBON	1K	5%	1/4W
L605	1-412-529-11	INDUCTOR	22 μ H			R412	1-216-113-00	RES-CHIP	470K	5%	1/10W
PHOTO COUPLER						R413	1-216-113-00	RES-CHIP	470K	5%	1/10W
\triangle PH601	8-749-010-64	PHOTO COUPLER PC123FY2				R414	1-249-417-11	CARBON	1K	5%	1/4W
IC LINK						R421	1-249-425-11	CARBON	4.7K	5%	1/4W
\triangle PS401	1-532-686-21	LINK, IC 2.7A/150V				R422	1-249-389-11	CARBON	4.7	5%	1/4W
TRANSISTOR						R426	1-216-009-91	RES-CHIP	22	5%	1/10W
Q101	8-729-422-27	TRANSISTOR 2SD601A-QRS-TX				R429	1-216-113-00	RES-CHIP	470K	5%	1/10W
Q410	8-729-422-27	TRANSISTOR 2SD601A-QRS-TX				R430	1-216-049-11	RES-CHIP	1K	5%	1/10W
Q411	8-729-424-02	TRANSISTOR 2SB709A-QRS-TX				R431	1-216-049-11	RES-CHIP	1K	5%	1/10W
Q501	8-729-140-50	TRANSISTOR 2SC3209LK-TP				R433	1-216-113-00	RES-CHIP	470K	5%	1/10W
						R436		VARIANT (SEE VARIANT PARTS LIST)			
						R437		VARIANT (SEE VARIANT PARTS LIST)			

NOTE: The components identified by shading and  mark are critical for safety. Replace only with part number specified.

NOTE: Les composants identifiés par un trame et une marque  sont critiques pour la sécurité. Ne les remplacer que par une pièce portant le numéro spécifique.



COMMON PARTS LISTING FS SERIES









REF. NO.	PART NO.	DESCRIPTION	VALUES			REF. NO.	PART NO.	DESCRIPTION	VALUES		
R438		VARIANT (SEE VARIANT PARTS LIST)				 R544	1-249-377-11	CARBON	0.47	5%	1/4W
R440	1-216-097-11	RES-CHIP	100K	5%	1/10W	R545	1-215-873-00	METAL	4.7K	5%	1W
R441	1-216-081-00	RES-CHIP	22K	5%	1/10W	 R546	1-249-377-11	CARBON	0.47	5%	1/4W
R442	1-208-758-11	METAL	100	0.50%	1/10W	R547	1-216-455-21	METAL	560	5%	2W
R445	1-216-073-91	RES-CHIP	10K	5%	1/10W	R548	1-216-377-11	METAL	4.7	5%	2W
R446	1-215-457-00	METAL	33K	1%	1/4W	 R549	1-260-288-11	CARBON	0.47	5%	1/2W
R447	1-216-065-91	RES-CHIP	4.7K	5%	1/10W	 R550	1-260-288-11	CARBON	0.47	5%	1/2W
R454	1-216-025-11	RES-CHIP	100	5%	1/10W	R551	1-215-907-11	METAL	22	5%	3W
R490		VARIANT (SEE VARIANT PARTS LIST)				 R553	1-216-363-00	METAL	0.33	5%	2W
R501	1-249-425-11	CARBON	4.7K	5%	1/4W	 R554	1-249-429-11	CARBON	10K	5%	1/4W
 R502	1-216-455-21	METAL	560	5%	2W	 R555	1-247-895-91	CARBON	470K	5%	1/4W
 R503	1-249-425-11	CARBON	4.7K	5%	1/4W	 R556	1-249-417-11	CARBON	1K	5%	1/4W
R505	1-249-401-11	CARBON	47	5%	1/4W	 R557	1-247-895-91	CARBON	470K	5%	1/4W
 R506	1-215-883-11	METAL	33	5%	2W	 R558	1-216-097-11	RES-CHIP	100K	5%	1/10W
 R507	1-260-328-11	CARBON	1K	5%	1/2W	 R559	1-216-073-91	RES-CHIP	10K	5%	1/10W
R508	1-249-433-11	CARBON	22K	5%	1/4W	 R560	1-215-879-11	METAL	47K	5%	1W
 R509	1-215-891-11	METAL	680	5%	2W	 R561	1-249-406-11	CARBON	120	5%	1/4W
R510	1-249-411-11	CARBON	330	5%	1/4W	R562	1-208-808-11	METAL	12K	0.50%	1/10W
R511	1-249-377-11	CARBON	0.47	5%	1/4W	 R563	1-249-433-11	CARBON	22K	5%	1/4W
R512	1-215-910-00	METAL	68	5%	3W	R564		VARIANT (SEE VARIANT PARTS LIST)			
R513		VARIANT (SEE VARIANT PARTS LIST)				 R565	1-249-429-11	CARBON	10K	5%	1/4W
R514		VARIANT (SEE VARIANT PARTS LIST)				 R566	1-216-073-91	RES-CHIP	10K	5%	1/10W
R516	1-249-425-11	CARBON	4.7K	5%	1/4W	 R567	1-216-073-91	RES-CHIP	10K	5%	1/10W
R517	1-215-445-00	METAL	10K	1%	1/4W	 R568	1-215-882-00	METAL	22	5%	2W
R518		VARIANT (SEE VARIANT PARTS LIST)				R569	1-214-798-21	METAL	1.8	1%	1/2W
R519		VARIANT (SEE VARIANT PARTS LIST)				R570	1-249-433-11	CARBON	22K	5%	1/4W
 R520	1-215-884-11	METAL	47	5%	2W	R571	1-216-065-91	RES-CHIP	4.7K	5%	1/10W
 R521	1-249-413-11	CARBON	470	5%	1/4W	R572	1-216-065-91	RES-CHIP	4.7K	5%	1/10W
R522	1-249-417-11	CARBON	1K	5%	1/4W	R601		VARIANT (SEE VARIANT PARTS LIST)			
R523	1-216-073-91	RES-CHIP	10K	5%	1/10W	 R602	1-249-389-11	CARBON	4.7	5%	1/4W
R524	1-249-429-11	CARBON	10K	5%	1/4W	R603	1-215-485-00	METAL	470K	1%	1/4W
 R525	1-208-804-11	METAL	8.2K	0.50%	1/10W	R607	1-215-859-00	METAL	22	5%	1W
R526	1-208-814-91	METAL	22K	0.50%	1/10W	R608	1-240-205-11	CARBON	22M	5%	1/2W
R528	1-215-429-00	METAL	2.2K	1%	1/4W	R609	1-216-049-11	RES-CHIP	1K	5%	1/10W
R529		VARIANT (SEE VARIANT PARTS LIST)				R610	1-216-073-91	RES-CHIP	10K	5%	1/10W
R530		VARIANT (SEE VARIANT PARTS LIST)				R611	1-216-089-91	RES-CHIP	47K	5%	1/10W
R532	1-215-437-00	METAL	4.7K	1%	1/4W	R612	1-216-045-00	RES-CHIP	680	5%	1/10W
R533		VARIANT (SEE VARIANT PARTS LIST)				 R613	1-219-512-11	CARBON	2.2M	5%	1/2W
R534		VARIANT (SEE VARIANT PARTS LIST)				R614	1-249-413-11	CARBON	470	5%	1/4W
R535	1-249-441-11	CARBON	100K	5%	1/4W	R615		VARIANT (SEE VARIANT PARTS LIST)			
 R536	1-214-798-21	METAL	1.8	1%	1/2W	 R616	1-260-302-51	CARBON	6.8	5%	1/2W
R537		VARIANT (SEE VARIANT PARTS LIST)				R617	1-216-009-91	RES-CHIP	22	5%	1/10W
 R538	1-215-889-00	METAL	330	5%	2W	R618	1-249-440-11	CARBON	82K	5%	1/4W
 R539	1-249-385-11	CARBON	2.2	5%	1/4W	R619	1-249-437-11	CARBON	47K	5%	1/4W
R540	1-215-445-00	METAL	10K	1%	1/4W	R620	1-249-417-11	CARBON	1K	5%	1/4W
R541	1-249-429-11	CARBON	10K	5%	1/4W	 R621	1-240-251-11	CEMENTED	6.8	5%	10W
R543	1-247-887-00	CARBON	220K	5%	1/4W	R622	1-249-441-11	CARBON	100K	5%	1/4W

NOTE: The components identified by shading and  mark are critical for safety. Replace only with part number specified.

NOTE: Les composants identifiés par un trame et une marque  sont critiques pour la sécurité. Ne les remplacer que par une pièce portant le numéro spécifique.



COMMON PARTS LISTING FS SERIES

REF. NO.	PART NO.	DESCRIPTION	VALUES			REF. NO.	PART NO.	DESCRIPTION	VALUES	
	R623	1-260-324-11	CARBON	470	5%	1/2W	SWITCH			
	R624	1-249-429-11	CARBON	10K	5%	1/4W	SW501	1-572-707-11	SWITCH LEVER	
	R625	1-249-437-11	CARBON	47K	5%	1/4W	SW502	1-572-707-11	SWITCH LEVER	
	R626	VARIANT (SEE VARIANT PARTS LIST)				TRANSFORMER				
	R627	VARIANT (SEE VARIANT PARTS LIST)					T501	1-437-195-11	TRANSFORMER, HORIZONTAL DRIVE	
	R628	VARIANT (SEE VARIANT PARTS LIST)					T503	1-426-981-11	TRANSFORMER, FERRITE (PMT)	
	R629	VARIANT (SEE VARIANT PARTS LIST)					T504	VARIANT (SEE VARIANT PARTS LIST)		
	R630	1-249-421-11	CARBON	2.2K	5%	1/4W		T505	VARIANT (SEE VARIANT PARTS LIST)	
	R631	VARIANT (SEE VARIANT PARTS LIST)					T602	VARIANT (SEE VARIANT PARTS LIST)		
	R632	VARIANT (SEE VARIANT PARTS LIST)					T603	VARIANT (SEE VARIANT PARTS LIST)		
	R633	1-249-415-11	CARBON	680	5%	1/4W		T604	1-431-852-11	TRANSFORMER, CONVERTER (SRT)
	R634	1-216-073-91	RES-CHIP	10K	5%	1/10W	THERMISTOR			
	R635	1-216-057-00	RES-CHIP	2.2K	5%	1/10W		TH501	1-800-193-00	THERMISTOR
	R637	VARIANT (SEE VARIANT PARTS LIST)					TH601	1-803-586-11	THERMISTOR, NTC	
	R638	VARIANT (SEE VARIANT PARTS LIST)				THERMISTOR				
	R639	1-249-421-11	CARBON	2.2K	5%	1/4W		THP601	VARIANT (SEE VARIANT PARTS LIST)	
	R640	1-249-417-11	CARBON	1K	5%	1/4W	TUNER			
	R641	VARIANT (SEE VARIANT PARTS LIST)					TU101	8-598-542-20	TUNER, FSS BTF-WA412	
	R642	1-216-089-91	RES-CHIP	47K	5%	1/10W	VARISTOR			
	R643	1-249-419-11	CARBON	1.5K	5%	1/4W		VDR601	VARIANT (SEE VARIANT PARTS LIST)	
	R644	1-247-843-11	CARBON	3.3K	5%	1/4W				
	R645	1-215-898-11	METAL	10K	5%	2W				
	R646	VARIANT (SEE VARIANT PARTS LIST)								
	R648	1-215-908-00	METAL	33	5%	3W				
	R649	1-249-417-11	CARBON	1K	5%	1/4W				
	R650	1-216-387-11	METAL	0.68	5%	3W				
	R651	1-249-429-11	CARBON	10K	5%	1/4W				
	R653	1-216-049-11	RES-CHIP	1K	5%	1/10W				
	R655	1-216-049-11	RES-CHIP	1K	5%	1/10W				
	R656	1-249-429-11	CARBON	10K	5%	1/4W				
	R658	1-216-387-11	METAL	0.68	5%	3W				
	R659	1-215-857-71	METAL	10	5%	1W				
	R660	VARIANT (SEE VARIANT PARTS LIST)								
	R661	1-216-057-00	RES-CHIP	2.2K	5%	1/10W				
	R662	VARIANT (SEE VARIANT PARTS LIST)								
	R663	1-216-081-00	RES-CHIP	22K	5%	1/10W				
	R2001	1-216-057-00	RES-CHIP	2.2K	5%	1/10W				
	R2002	1-216-053-00	RES-CHIP	1.5K	5%	1/10W				
	R2003	1-249-425-11	CARBON	4.7K	5%	1/4W				
	R2004	1-216-069-00	RES-CHIP	6.8K	5%	1/10W				
	R2005	1-216-295-91	SHORT							
RELAY										
	RY601	1-755-198-11	RELAY							
	RY602	1-755-266-11	RELAY, AC POWER							
SWITCH										
	S2007	1-762-816-11	SWITCH TACTILE							
	S2008	1-762-816-11	SWITCH TACTILE							

NOTE: The components identified by shading and \triangle mark are critical for safety. Replace only with part number specified.

NOTE: Les composants identifiés par un trame et une marque \triangle sont critiques pour la sécurité. Ne les remplacer que par une pièce portant le numéro spécifique.



COMMON PARTS LISTING FV SERIES

REF. NO.	PART NO.	DESCRIPTION	VALUES			REF. NO.	PART NO.	DESCRIPTION	VALUES		
A BOARD COMMON PARTS LISTING FV SERIES											
A											
*	A-1299-243-A	A COMPLETE PC BOARD (KV-27FV17 ONLY)									
*	A-1299-498-A	A COMPLETE PC BOARD (KV-29FV17 ONLY)									
*	A-1299-244-A	A COMPLETE PC BOARD (KV-27FV17C ONLY)									
		The high-voltage leads associated with the FBT on the A board are not included and must be ordered separately. Order the following leads when requesting this A board:									
\triangle	1-251-374-13	HV CAP ASSY									
\triangle	1-900-800-82	FOCUS LEAD									
\triangle	1-900-803-22	G2 LEAD									
*	1-508-784-21	PIN, CONNECTOR (5MM PITCH)	1P								
	1-533-223-11	HOLDER, FUSE									
*	4-374-846-11	COVER, CAPACITOR, CAP TYPE									
	4-382-854-11	SCREW (M3X10), P, SW (+)									
	CAPACITOR										
	C100	1-216-295-91	SHORT								
	C101	1-216-295-91	SHORT								
	C102	1-126-933-11	ELECT	100 μ F	20%	16V					
	C104	1-126-941-11	ELECT	470 μ F	20%	25V					
	C105	1-104-664-11	ELECT	47 μ F	20%	25V					
	C204	1-163-017-00	CERAMIC CHIP	0.0047 μ F	10%	50V					
	C205	1-126-963-11	ELECT	4.7 μ F	20%	50V					
	C207	1-126-961-11	ELECT	2.2 μ F	20%	50V					
	C208	1-126-961-11	ELECT	2.2 μ F	20%	50V					
	C211	1-126-935-11	ELECT	470 μ F	20%	16V					
	C212	1-126-963-11	ELECT	4.7 μ F	20%	50V					
	C213	1-126-963-11	ELECT	4.7 μ F	20%	50V					
	C214	1-164-346-11	CERAMIC CHIP	1 μ F		16V					
	C215	1-164-346-11	CERAMIC CHIP	1 μ F		16V					
	C219	1-126-964-11	ELECT	10 μ F	20%	50V					
	C401	1-126-968-11	ELECT	100 μ F	20%	50V					
	C402	1-126-972-11	ELECT	1000 μ F	20%	50V					
	C403	1-126-957-11	ELECT	0.22 μ F	20%	50V					
	C420	1-164-222-91	CERAMIC CHIP	0.22 μ F		25V					
	C421	1-216-295-91	SHORT								
	C435	1-164-222-91	CERAMIC CHIP	0.22 μ F		25V					
	C441	1-164-346-11	CERAMIC CHIP	1 μ F		16V					
	C442	1-126-963-11	ELECT	4.7 μ F	20%	50V					
	C496	1-216-295-91	SHORT								
	C501	1-102-114-00	CERAMIC	470pF	10%	50V					
	C502	1-106-383-00	MYLAR	0.047 μ F	10%	200V					
	C503	1-102-228-00	CERAMIC	470pF	10%	500V					
	C504	1-102-228-00	CERAMIC	470pF	10%	500V					
\triangle	C505	1-162-116-00	CERAMIC	680pF	10%	2KV					
	C506	1-162-318-11	CERAMIC	0.001 μ F	10%	500V					
\triangle	C507	1-117-717-11	FILM	17000pF	3%	1.2KV					
\triangle	C508	1-137-150-11	MYLAR	0.01 μ F	10%	100V					
\triangle	C509	1-162-116-00	CERAMIC	680pF	10%	2KV					
	C510	1-107-649-11	ELECT	2.2 μ F	20%	250V					
\triangle	C511	1-115-522-11	FILM	1 μ F	5%	250V					
\triangle	C512	1-106-387-00	MYLAR	0.068 μ F	10%	200V					
	C513	1-104-987-11	MYLAR	0.001 μ F	10%	100V					
	C514	1-109-844-11	FILM	0.68 μ F	5%	250V					
\triangle	C515	1-162-116-00	CERAMIC	680pF	10%	2KV					
\triangle	C520	1-129-722-00	FILM	0.047 μ F	5%	630V					
	C521	1-164-646-11	CERAMIC	2200pF	10%	500V					
	C523	1-126-941-11	ELECT	470 μ F	20%	25V					
	C524	1-102-244-00	CERAMIC	220pF	10%	500V					
	C525	1-107-612-11	CERAMIC	100pF	5%	500V					
	C526	1-126-960-11	ELECT	1 μ F	20%	50V					
	C527	1-126-965-91	ELECT	22 μ F	20%	50V					
	C528	1-164-161-11	CERAMIC CHIP	0.0022 μ F	10%	50V					
	C529	1-164-161-11	CERAMIC CHIP	0.0022 μ F	10%	50V					
	C530	1-164-161-11	CERAMIC CHIP	0.0022 μ F	10%	50V					
	C531	1-106-387-00	MYLAR	0.068 μ F	10%	200V					
	C533	1-126-941-11	ELECT	470 μ F	20%	25V					
\triangle	C534	1-126-964-11	ELECT	10 μ F	20%	50V					
	C535	1-126-959-11	ELECT	0.47 μ F	20%	50V					
	C536	1-102-228-00	CERAMIC	470pF	10%	500V					
\triangle	C537	1-126-965-91	ELECT	22 μ F	20%	50V					
	C539	1-107-662-11	ELECT	22 μ F	20%	250V					
	C540	1-107-645-11	ELECT	22 μ F	20%	160V					
	C541	1-126-969-11	ELECT	220 μ F	20%	50V					
	C542	1-126-967-11	ELECT	47 μ F	20%	50V					
	C543	1-136-169-00	FILM	0.22 μ F	5%	50V					
\triangle	C546	1-126-965-91	ELECT	22 μ F	20%	50V					
\triangle	C547	1-163-031-91	CERAMIC CHIP	0.01 μ F		50V					
	C548	1-104-710-11	ELECT	22 μ F		160V					
	C549	1-126-934-11	ELECT	220 μ F	20%	16V					
	C550	1-107-846-11	FILM	0.1 μ F	5%	250V					
\triangle	C551	1-137-417-11	MYLAR	0.0047 μ F	10%	200V					
	C553	1-107-662-11	ELECT	22 μ F	20%	250V					
	C554	1-102-110-00	CERAMIC	220pF	10%	50V					
\triangle	C555	1-117-629-11	FILM	2700pF	3%	1.2KV					
	C601	1-164-004-11	CERAMIC CHIP	0.1 μ F	10%	25V					
	C602	1-126-967-11	ELECT	47 μ F	20%	50V					
	C604	1-164-182-11	CERAMIC CHIP	0.0033 μ F	10%	50V					
\triangle	C606	1-113-920-11	CERAMIC	0.0022 μ F	20%	250V					
	C607		VARIANT (SEE VARIANT PARTS LIST)								
	C609	1-126-968-11	ELECT	100 μ F	20%	50V					

NOTE: The components identified by shading and \triangle mark are critical for safety. Replace only with part number specified.

NOTE: Les composants identifiés par un trame et une marque \triangle sont critiques pour la sécurité. Ne les remplacer que par une pièce portant le numéro spécifique.



COMMON PARTS LISTING FV SERIES

REF. NO.	PART NO.	DESCRIPTION	VALUES	REF. NO.	PART NO.	DESCRIPTION	VALUES
\triangle D517	8-719-991-33	DIODE 1SS133T-77		FB605	1-412-911-11	FERRITE	0 μ H
\triangle D518	8-719-921-63	DIODE MTZJ-T-77-7.5X		FB606	1-412-911-11	FERRITE	0 μ H
\triangle D519	8-719-979-84	DIODE EGP20DPKG23		FB607	1-412-911-11	FERRITE	0 μ H
\triangle D520	8-719-404-50	DIODE MA111-TX		FB608	1-412-911-11	FERRITE	0 μ H
D521	8-719-991-33	DIODE 1SS133T-77		FB609	1-412-911-11	FERRITE	0 μ H
D522	8-719-404-50	DIODE MA111-TX		FB610	1-412-911-11	FERRITE	0 μ H
D601	8-719-991-33	DIODE 1SS133T-77		IC			
D602	8-719-991-33	DIODE 1SS133T-77		\triangle IC402	8-759-573-40	IC TDA8580Q/N1	
D603	8-719-982-26	DIODE MTZJ-T-77-33B		\triangle IC501	8-759-700-07	IC NJM2903M-TE2	
D604	8-719-028-72	DIODE RGP02-17PKG23		IC502	8-759-980-58	IC TDA8172	
\triangle D605	8-719-510-53	DIODE D4SB60L-F		IC601		VARIANT (SEE VARIANT PARTS LIST)	
\triangle D606	8-719-108-18	DIODE TF541M		\triangle IC602	8-749-016-47	IC EA135-F12	
D607	8-719-991-33	DIODE 1SS133T-77		IC603	8-759-653-07	IC PQ09RD21	
D608	8-719-110-53	DIODE MTZJ-T-77-20B		IC604	8-759-924-12	IC LM7805CT	
D609	8-719-311-31	DIODE RU-1P		JACK			
D610	8-719-210-21	DIODE 11EQS04-NTA1B		J201	1-794-119-11	TERMINAL BLOCK, S 4P	
D611	8-719-046-74	DIODE 10ELS2N-TA1B2		J203	1-794-118-11	JACK BLOCK, PIN 3P	
D612	8-719-110-17	DIODE MTZJ-T-77-10B		J204	1-794-118-11	JACK BLOCK, PIN 3P	
D613	8-719-046-74	DIODE 10ELS2N-TA1B2		J205	1-794-116-11	JACK BLOCK, PIN 2P	
D614	8-719-046-74	DIODE 10ELS2N-TA1B2		J206	1-794-117-11	JACK BLOCK, PIN 3P	
D615	8-719-312-10	DIODE RU4AM-T3		J402	1-794-116-11	JACK BLOCK, PIN 2P	
D616	8-719-510-37	DIODE D5LC20U		CHIP CONDUCTOR			
D617	8-719-110-31	DIODE MTZJ-T-77-12C		JR001	1-216-295-91	SHORT	
D618	8-719-991-33	DIODE 1SS133T-77		JR002	1-216-295-91	SHORT	
D619	8-719-110-17	DIODE MTZJ-T-77-10B		JR402	1-216-295-91	SHORT	
D620	8-719-510-37	DIODE D5LC20U		JR403	1-216-295-91	SHORT	
D622	8-719-077-76	DIODE D2SB60A-F04		JR404	1-216-295-91	SHORT	
D623	8-719-081-70	DIODE BA159DGPPKG3		JR405	1-216-295-91	SHORT	
D624	8-719-991-33	DIODE 1SS133T-77		JR410	1-216-295-91	SHORT	
D625	8-719-991-33	DIODE 1SS133T-77		JR411	1-216-295-91	SHORT	
D626	8-719-046-74	DIODE 10ELS2N-TA1B2		JR471	1-164-222-91	CERAMIC CHIP	0.22 μ F 25V
D627	8-719-110-03	DIODE MTZJ-T-77-7.5A		JR472	1-216-295-91	SHORT	
D628	8-719-510-48	DIODE D1N20R-TA		JR501	1-216-295-91	SHORT	
D2002	8-719-110-17	DIODE MTZJ-T-77-10B		JR502	1-216-295-91	SHORT	
D2004	8-719-921-44	DIODE MTZJ-T-77-5.1C		JR503	1-216-295-91	SHORT	
D2005	8-719-921-44	DIODE MTZJ-T-77-5.1C		JR505	1-216-295-91	SHORT	
				JR522	1-216-295-91	SHORT	
FUSE				JR523	1-216-295-91	SHORT	
F601		VARIANT (SEE VARIANT PARTS LIST)		JR526	1-216-295-91	SHORT	
FERRITE BEAD				JR527	1-216-295-91	SHORT	
FB501	1-410-397-21	FERRITE	1.1 μ H	JR2003	1-216-295-91	SHORT	
FB502	1-410-397-21	FERRITE	1.1 μ H	COIL			
FB503	1-410-397-21	FERRITE	1.1 μ H	L101	1-412-029-11	INDUCTOR	10 μ H
FB600	1-412-911-11	FERRITE	0 μ H	L102	1-412-032-11	INDUCTOR	100 μ H
FB601	1-412-911-11	FERRITE	0 μ H	L103	1-412-029-11	INDUCTOR	10 μ H
FB602	1-412-911-11	FERRITE	0 μ H	L501	1-409-955-11	INDUCTOR	8mH
FB603	1-412-911-11	FERRITE	0 μ H	L502	1-412-552-11	INDUCTOR	2.2mH
FB604	1-412-911-11	FERRITE	0 μ H				

NOTE: The components identified by shading and \triangle mark are critical for safety. Replace only with part number specified.

NOTE: Les composants identifiés par un trame et une marque \triangle sont critiques pour la sécurité. Ne les remplacer que par une pièce portant le numéro spécifique.



COMMON PARTS LISTING FV SERIES

REF. NO.	PART NO.	DESCRIPTION	VALUES	REF. NO.	PART NO.	DESCRIPTION	VALUES
L503	1-406-677-11	INDUCTOR	10mH	R204	1-216-081-00	RES-CHIP	22K 5% 1/10W
L504	1-412-533-21	INDUCTOR	47 μ H	R205	1-216-085-91	RES-CHIP	33K 5% 1/10W
L505	1-406-978-11	INDUCTOR	150 μ H	R208	1-215-924-00	METAL OXIDE	15K 5% 3W
L506	1-406-677-11	INDUCTOR	10mH	R210	1-216-022-00	RES-CHIP	75 5% 1/10W
L507	1-412-552-11	INDUCTOR	2.2mH	R214	1-216-113-00	RES-CHIP	470K 5% 1/10W
\triangle L510	1-412-528-11	INDUCTOR	18 μ H	R215	1-216-113-00	RES-CHIP	470K 5% 1/10W
L603	1-412-529-11	INDUCTOR	22 μ H	R218		VARIANT (SEE VARIANT PARTS LIST)	
L604	1-412-525-31	INDUCTOR	10 μ H	R221	1-216-033-00	RES-CHIP	220 5% 1/10W
L605	1-412-529-11	INDUCTOR	22 μ H	R224	1-208-798-11	METAL CHIP	4.7K 0.50% 1/10W
PHOTO COUPLER				R225	1-208-798-11	METAL CHIP	4.7K 0.50% 1/10W
\triangle PH601	8-749-010-64	PHOTO COUPLER PC123FY2		R226	1-216-022-00	RES-CHIP	75 5% 1/10W
IC LINK				R227	1-216-113-00	RES-CHIP	470K 5% 1/10W
\triangle PS401	1-532-686-21	LINK, IC 2.7A/150V		R228	1-216-113-00	RES-CHIP	470K 5% 1/10W
TRANSISTOR				R229	1-216-113-00	RES-CHIP	470K 5% 1/10W
Q101	8-729-422-27	TRANSISTOR 2SD601A-QRS-TX		R231	1-216-069-00	RES-CHIP	6.8K 5% 1/10W
Q201	8-729-424-02	TRANSISTOR 2SB709A-QRS-TX		R232	1-216-069-00	RES-CHIP	6.8K 5% 1/10W
Q205	8-729-422-27	TRANSISTOR 2SD601A-QRS-TX		R401	1-216-080-00	RES-CHIP	20K 5% 1/10W
Q206	8-729-422-27	TRANSISTOR 2SD601A-QRS-TX		R402	1-216-073-91	RES-CHIP	10K 5% 1/10W
Q401	8-729-424-02	TRANSISTOR 2SB709A-QRS-TX		R403	1-208-798-11	METAL CHIP	4.7K 0.50% 1/10W
Q402	8-729-424-02	TRANSISTOR 2SB709A-QRS-TX		R404	1-208-798-11	METAL CHIP	4.7K 0.50% 1/10W
Q410	8-729-422-27	TRANSISTOR 2SD601A-QRS-TX		R407	1-208-758-11	METAL CHIP	100 0.50% 1/10W
Q411	8-729-424-02	TRANSISTOR 2SB709A-QRS-TX		R408	1-208-758-11	METAL CHIP	100 0.50% 1/10W
Q501	8-729-140-50	TRANSISTOR 2SC3209LK-TP		R411	1-249-417-11	CARBON	1K 5% 1/4W
\triangle Q502	8-729-046-07	TRANSISTOR 2SD2578-YB		R412	1-216-113-00	RES-CHIP	470K 5% 1/10W
\triangle Q503	8-729-422-27	TRANSISTOR 2SD601A-QRS-TX		R413	1-216-113-00	RES-CHIP	470K 5% 1/10W
\triangle Q504	8-729-053-87	TRANSISTOR KTC4370A		R414	1-249-417-11	CARBON	1K 5% 1/4W
\triangle Q505	8-729-200-17	TRANSISTOR 2SA10910-TPE2		R421	1-249-425-11	CARBON	4.7K 5% 1/4W
\triangle Q506	8-729-422-27	TRANSISTOR 2SD601A-QRS-TX		R422	1-249-389-11	CARBON	4.7 5% 1/4W
\triangle Q507	8-729-424-02	TRANSISTOR 2SB709A-QRS-TX		R426	1-216-009-91	RES-CHIP	22 5% 1/10W
Q601	8-729-922-37	TRANSISTOR 2SD2144S-TP-UVV		R429	1-216-113-00	RES-CHIP	470K 5% 1/10W
Q602	8-729-423-33	TRANSISTOR 2SC3311A-QRSTA		R430	1-216-049-11	RES-CHIP	1K 5% 1/10W
\triangle Q603	8-729-119-76	TRANSISTOR 2SA1309A-QRSTA		R431	1-216-049-11	RES-CHIP	1K 5% 1/10W
Q604	8-729-422-27	TRANSISTOR 2SD601A-QRS-TX		R433	1-216-113-00	RES-CHIP	470K 5% 1/10W
\triangle Q605	8-729-046-40	TRANSISTOR 2SK2663		R436	1-208-798-11	METAL CHIP	4.7K 0.50% 1/10W
Q606	8-729-422-27	TRANSISTOR 2SD601A-QRS-TX		R437	1-216-073-91	RES-CHIP	10K 5% 1/10W
Q607	8-729-922-37	TRANSISTOR 2SD2144S-TP-UVV		R438	1-208-798-11	METAL CHIP	4.7K 0.50% 1/10W
Q608	8-729-422-27	TRANSISTOR 2SD601A-QRS-TX		R440	1-216-097-11	RES-CHIP	100K 5% 1/10W
Q609	8-729-423-33	TRANSISTOR 2SC3311A-QRSTA		R441	1-216-081-00	RES-CHIP	22K 5% 1/10W
RESISTOR				R442	1-208-758-11	METAL CHIP	100 0.50% 1/10W
R105	1-208-798-11	METAL CHIP	4.7K 0.50% 1/10W	R445	1-216-073-91	RES-CHIP	10K 5% 1/10W
R107	1-216-025-11	RES-CHIP	100 5% 1/10W	R446	1-215-457-00	METAL	33K 1% 1/4W
R108	1-216-025-11	RES-CHIP	100 5% 1/10W	R447	1-216-065-91	RES-CHIP	4.7K 5% 1/10W
R115	1-216-295-91	SHORT		R454	1-216-025-11	RES-CHIP	100 5% 1/10W
R201	1-216-113-00	RES-CHIP	470K 5% 1/10W	R490	1-216-073-91	RES-CHIP	10K 5% 1/10W
R202	1-216-113-00	RES-CHIP	470K 5% 1/10W	R501	1-249-425-11	CARBON	4.7K 5% 1/4W
R203	1-216-022-00	RES-CHIP	75 5% 1/10W	\triangle R502	1-216-455-21	METAL OXIDE	560 5% 2W
				\triangle R503	1-249-425-11	CARBON	4.7K 5% 1/4W

NOTE: The components identified by shading and \triangle mark are critical for safety. Replace only with part number specified.

A component identified by this \boxtimes symbol indicates that it has been carefully factory-selected to satisfy regulations regarding X-ray radiation. Should replacement be required, replace only with the value originally used.



COMMON PARTS LISTING FV SERIES

REF. NO.	PART NO.	DESCRIPTION	VALUES			REF. NO.	PART NO.	DESCRIPTION	VALUES				
	R505	1-249-401-11	CARBON	47	5%	1/4W							
\triangle	R506	1-215-883-11	METAL OXIDE	33	5%	2W	\triangle	R560	1-215-879-11	METAL OXIDE	47K	5%	1W
\triangle	R507	1-260-328-11	CARBON	1K	5%	1/2W	\triangle	R561	1-249-406-11	CARBON	120	5%	1/4W
	R508	1-249-433-11	CARBON	22K	5%	1/4W	\triangle	R562	1-208-808-11	METAL CHIP	12K	0.50%	1/10W
\triangle	R509	1-215-891-11	METAL OXIDE	680	5%	2W							
	R510	1-249-411-11	CARBON	330	5%	1/4W	\triangle	R563	1-249-433-11	CARBON	22K	5%	1/4W
	R511	1-249-377-11	CARBON	0.47	5%	1/4W	\triangle	\boxtimes R564	1-208-836-11	METAL CHIP	180K	0.50%	1/10W
	R512	1-215-910-00	METAL OXIDE	68	5%	3W	\triangle	R565	1-249-429-11	CARBON	10K	5%	1/4W
\triangle	R513	1-215-907-11	METAL OXIDE	22	5%	3W	\triangle	R566	1-216-073-91	RES-CHIP	10K	5%	1/10W
	R514	1-216-683-11	METAL CHIP	22K	0.50%	1/10W	\triangle	R567	1-216-073-91	RES-CHIP	10K	5%	1/10W
	R516	1-249-425-11	CARBON	4.7K	5%	1/4W	\triangle	R568	1-215-882-00	METAL OXIDE	22	5%	2W
	R517	1-215-445-00	METAL	10K	1%	1/4W							
	R518	1-249-427-11	CARBON	6.8K	5%	1/4W		R569	1-214-798-21	METAL	1.8	1%	1/2W
	R519	1-249-427-11	CARBON	6.8K	5%	1/4W		R570	1-249-433-11	CARBON	22K	5%	1/4W
\triangle	R520	1-215-884-11	METAL OXIDE	47	5%	2W		R571	1-216-065-91	RES-CHIP	4.7K	5%	1/10W
\triangle	R521	1-249-413-11	CARBON	470	5%	1/4W		R572	1-216-065-91	RES-CHIP	4.7K	5%	1/10W
	R522	1-249-417-11	CARBON	1K	5%	1/4W		R601		VARIANT (SEE VARIANT PARTS LIST)			
	R523	1-216-073-91	RES-CHIP	10K	5%	1/10W	\triangle	R602	1-249-389-11	CARBON	4.7	5%	1/4W
	R524	1-249-429-11	CARBON	10K	5%	1/4W		R603	1-215-485-00	METAL	470K	1%	1/4W
\triangle	R525	1-208-804-11	METAL CHIP	8.2K	0.50%	1/10W		R607	1-215-859-00	METAL OXIDE	22	5%	1W
	R526	1-208-814-91	METAL CHIP	22K	0.50%	1/10W		R608	1-240-205-11	CARBON	22M	5%	1/2W
	R528	1-215-429-00	METAL	2.2K	1%	1/4W		R609	1-216-049-11	RES-CHIP	1K	5%	1/10W
	R529	1-216-109-00	RES-CHIP	330K	5%	1/10W		R610	1-216-073-91	RES-CHIP	10K	5%	1/10W
	R530	1-216-077-91	RES-CHIP	15K	5%	1/10W		R611	1-216-089-91	RES-CHIP	47K	5%	1/10W
	R532	1-215-437-00	METAL	4.7K	1%	1/4W		R612	1-216-045-00	RES-CHIP	680	5%	1/10W
	R533	1-215-457-00	METAL	33K	1%	1/4W	\triangle	R613	1-219-512-11	CARBON	2.2M	5%	1/2W
	R534	1-215-458-00	METAL	36K	1%	1/4W		R614	1-249-413-11	CARBON	470	5%	1/4W
	R535	1-249-441-11	CARBON	100K	5%	1/4W		R615		VARIANT (SEE VARIANT PARTS LIST)			
\triangle	R536	1-214-798-21	METAL	1.8	1%	1/2W	\triangle	R616	1-260-302-51	CARBON	6.8	5%	1/2W
\triangle	R538	1-215-889-00	METAL OXIDE	330	5%	2W		R617	1-216-009-91	RES-CHIP	22	5%	1/10W
\triangle	R539	1-249-385-11	CARBON	2.2	5%	1/4W		R618	1-249-440-11	CARBON	82K	5%	1/4W
	R540	1-215-445-00	METAL	10K	1%	1/4W		R619	1-249-437-11	CARBON	47K	5%	1/4W
	R541	1-249-429-11	CARBON	10K	5%	1/4W		R620	1-249-417-11	CARBON	1K	5%	1/4W
	R543	1-247-887-00	CARBON	220K	5%	1/4W	\triangle	R621	1-240-251-11	CEMENTED	6.8	5%	10W
\triangle	R544	1-249-377-11	CARBON	0.47	5%	1/4W		R622	1-249-441-11	CARBON	100K	5%	1/4W
	R545	1-215-873-00	METAL OXIDE	4.7K	5%	1W	\triangle	R623	1-260-324-11	CARBON	470	5%	1/2W
\triangle	R546	1-249-377-11	CARBON	0.47	5%	1/4W							
	R547	1-216-455-21	METAL OXIDE	560	5%	2W	\triangle	R624	1-249-429-11	CARBON	10K	5%	1/4W
	R548	1-216-377-11	METAL OXIDE	4.7	5%	2W		R625	1-249-437-11	CARBON	47K	5%	1/4W
\triangle	R549	1-260-288-11	CARBON	0.47	5%	1/2W	\triangle	R626	1-202-933-61	FUSIBLE	0.1	10%	1/2W
\triangle	R550	1-260-288-11	CARBON	0.47	5%	1/2W		R627		VARIANT (SEE VARIANT PARTS LIST)			
	R551	1-215-907-11	METAL OXIDE	22	5%	3W		R628		VARIANT (SEE VARIANT PARTS LIST)			
\triangle	R553	1-216-363-00	METAL OXIDE	0.33	5%	2W		R629		VARIANT (SEE VARIANT PARTS LIST)			
\triangle	R554	1-249-429-11	CARBON	10K	5%	1/4W		R630	1-249-421-11	CARBON	2.2K	5%	1/4W
\triangle	R555	1-247-895-91	CARBON	470K	5%	1/4W		R631		VARIANT (SEE VARIANT PARTS LIST)			
\triangle	R556	1-249-417-11	CARBON	1K	5%	1/4W	\triangle	R632	1-217-611-00	METAL	0.1	10%	2W
\triangle	R557	1-247-895-91	CARBON	470K	5%	1/4W		R633	1-249-415-11	CARBON	680	5%	1/4W
\triangle	R558	1-216-097-11	RES-CHIP	100K	5%	1/10W		R634	1-216-073-91	RES-CHIP	10K	5%	1/10W
\triangle	R559	1-216-073-91	RES-CHIP	10K	5%	1/10W		R635	1-216-057-00	RES-CHIP	2.2K	5%	1/10W
								R637		VARIANT (SEE VARIANT PARTS LIST)			
								R638		VARIANT (SEE VARIANT PARTS LIST)			

NOTE: The components identified by shading and \triangle mark are critical for safety. Replace only with part number specified.

NOTE: Les composants identifiés par un trame et une marque \triangle sont critiques pour la sécurité. Ne les remplacer que par une pièce portant le numéro spécifique.



COMMON PARTS LISTING FV SERIES

REF. NO.	PART NO.	DESCRIPTION	VALUES			REF. NO.	PART NO.	DESCRIPTION	VALUES
R639	1-249-421-11	CARBON	2.2K	5%	1/4W				
R640	1-249-417-11	CARBON	1K	5%	1/4W				
\triangle R641	1-216-369-00	METAL OXIDE	1	5%	2W				
R642	1-216-089-91	RES-CHIP	47K	5%	1/10W				
R643	1-249-419-11	CARBON	1.5K	5%	1/4W				
R644	1-247-843-11	CARBON	3.3K	5%	1/4W				
R645	1-215-898-11	METAL OXIDE	10K	5%	2W				
R646		VARIANT (SEE VARIANT PARTS LIST)							
R648	1-216-398-11	METAL OXIDE	5.6	5%	3W				
R649	1-249-417-11	CARBON	1K	5%	1/4W				
R650	1-216-387-11	METAL OXIDE	0.68	5%	3W				
R651	1-249-429-11	CARBON	10K	5%	1/4W				
R653	1-216-049-11	RES-CHIP	1K	5%	1/10W				
R655	1-216-049-11	RES-CHIP	1K	5%	1/10W				
R656	1-249-429-11	CARBON	10K	5%	1/4W				
R658	1-216-387-11	METAL OXIDE	0.68	5%	3W				
R659	1-215-857-71	METAL OXIDE	10	5%	1W				
R660		VARIANT (SEE VARIANT PARTS LIST)							
R661	1-216-057-00	RES-CHIP	2.2K	5%	1/10W				
R662		VARIANT (SEE VARIANT PARTS LIST)							
R663	1-216-081-00	RES-CHIP	22K	5%	1/10W				
R664	1-216-398-11	METAL OXIDE	5.6	5%	3W				
R2003	1-249-425-11	CARBON	4.7K	5%	1/4W				
RELAY									
\triangle RY601	1-755-198-11	RELAY							
\triangle RY602	1-755-266-11	RELAY, AC POWER							
SWITCH									
SW501	1-572-707-11	SWITCH LEVER							
SW502	1-572-707-11	SWITCH LEVER							
TRANSFORMER									
\triangle T501	1-437-195-11	TRANSFORMER, HORIZONTAL DRIVE							
\triangle T503	1-426-981-11	TRANSFORMER, FERRITE (PMT)							
\triangle T504	1-431-693-11	TRANSFORMER, HORIZONTAL LINEAR							
\triangle T505	1-453-310-11	FBT ASSY NX-4521//X4J4							
T602		VARIANT (SEE VARIANT PARTS LIST)							
T603		VARIANT (SEE VARIANT PARTS LIST)							
\triangle T604	1-431-852-11	TRANSFORMER, CONVERTER (SRT)							
THERMISTOR									
TH501	1-800-193-00	THERMISTOR							
\triangle TH601	1-803-586-11	THERMISTOR, NTC							
THERMISTOR									
\triangle THP601	1-803-540-11	THERMISTOR							
TUNER									
\triangle TU101	8-598-542-20	TUNER, FSS BTF-WA412							

REF. NO.	PART NO.	DESCRIPTION	VALUES
	VARISTOR		
VDR601		VARIANT (SEE VARIANT PARTS LIST)	

NOTE: The components identified by shading and \triangle mark are critical for safety. Replace only with part number specified.

A component identified by this \boxtimes symbol indicates that it has been carefully factory-selected to satisfy regulations regarding X-ray radiation. Should replacement be required, replace only with the value originally used.

VARIANT PARTS LISTING



The parts on this page belong to the following model(s) only:
KV-27FS13

REF. NO.	PART NO.	DESCRIPTION	VALUES			REF. NO.	PART NO.	DESCRIPTION	VALUES		
A BOARD VARIANT PARTS LIST (KV-27FS13)											
*	A-1299-502-A	A COMPLETE PC BOARD									
CAPACITOR											
\triangle	C507	1-117-717-11	FILM	17000pF	3%	1.2KV					
\triangle	C511	1-115-522-11	FILM	1 μ F	5%	250V					
	C514	1-109-844-11	FILM	0.68 μ F	5%	250V					
\triangle	C520	1-129-722-00	FILM	0.047 μ F	5%	630V					
	C530	1-164-161-11	CERAMIC CHIP	0.0022 μ F	10%	50V					
	C548	1-104-710-11	ELECT	22 μ F		160V					
	C550	1-107-846-11	FILM	0.1 μ F	5%	250V					
\triangle	C555	1-117-629-11	FILM	2700pF	3%	1.2KV					
\triangle	C607	1-136-311-11	MYLAR	0.47 μ F	20%	125V					
\triangle	C612	1-128-717-11	ELECT	680 μ F	20%	250V					
	C625	1-135-412-51	ELECT	1000 μ F	20%	25V					
	C630	1-127-795-51	CERAMIC	3300pF	20%	250V					
	C631	1-113-924-11	CERAMIC	4700pF	20%	250V					
	C658	1-135-412-51	ELECT	1000 μ F	20%	25V					
FERRITE BEAD											
	FB605	1-412-911-11	FERRITE	0 μ H							
IC											
	IC502	8-759-980-58	IC TDA8172								
\triangle	IC601	8-749-018-43	IC STR-F6426								
COIL											
	L505	1-406-978-11	INDUCTOR	150 μ H							
TRANSISTOR											
\triangle	Q502	8-729-046-07	TRANSISTOR 2SD2578-YB								
RESISTOR											
	R436	1-216-069-00	RES-CHIP	6.8K	5%	1/10W					
	R437	1-216-065-91	RES-CHIP	4.7K	5%	1/10W					
	R438	1-216-069-00	RES-CHIP	6.8K	5%	1/10W					
	R490	1-208-798-11	METAL CHIP	4.7K	1%	1/10W					
\triangle	R513	1-215-907-11	METAL OXIDE	22	5%	3W					
	R514	1-216-683-11	METAL CHIP	22K	1%	1/10W					
	R518	1-249-427-11	CARBON	6.8K	5%	1/4W					
	R519	1-249-427-11	CARBON	6.8K	5%	1/4W					
	R529	1-216-109-00	RES-CHIP	330K	5%	1/10W					
	R530	1-216-077-91	RES-CHIP	15K	5%	1/10W					
	R533	1-215-457-00	METAL	33K	1%	1/4W					
	R534	1-215-458-00	METAL	36K	1%	1/4W					
\triangle	\boxtimes R564	1-208-836-11	METAL CHIP	180K	1%	1/10W					
\triangle	R601	1-219-513-11	CARBON	4.7M	5%	1/2W					
\triangle	R626	1-220-926-11	FUSIBLE	0.47	10%	1/2W					
	R627	1-215-483-00	METAL	390K	1%	1/4W					
\triangle	R632	1-216-361-00	METAL OXIDE	0.22	5%	2W					
	R638	1-249-399-11	CARBON	33	5%	1/4W					
\triangle	R641	1-216-362-11	METAL OXIDE	0.27	5%	2W					
	R646	1-249-419-11	CARBON	1.5K	5%	1/4W					
\triangle	R660	1-215-924-00	METAL OXIDE	15K	5%	3W					
TRANSFORMER											
\triangle	T504	1-431-693-11	TRANSFORMER, HORIZONTAL LINEAR								
\triangle	T505	1-453-310-11	FBT ASSY NX-4521//X4J4								
\triangle	T602	1-435-617-11	TRANSFORMER, LINE FILTER								
\triangle	T603	1-433-806-21	TRANSFORMER, REGULAT								
THERMISTOR											
\triangle	THP601	1-803-540-11	THERMISTOR								
VARISTOR											
\triangle	VDR601	1-803-585-11	VARISTOR ENE271D-10A								

NOTE: The components identified by shading and \triangle mark are critical for safety. Replace only with part number specified.

A component identified by this \boxtimes symbol indicates that it has been carefully factory-selected to satisfy regulations regarding X-ray radiation. Should replacement be required, replace only with the value originally used.

VARIANT PARTS LISTING



The parts on this page belong to the following model(s) only:
KV-27FS17

REF. NO.	PART NO.	DESCRIPTION	VALUES	REF. NO.	PART NO.	DESCRIPTION	VALUES
A BOARD VARIANT PARTS LIST (KV-27FS17)							
*	A-1299-503-A	A COMPLETE PC BOARD					
<u>CAPACITOR</u>							
\triangle	C507	1-117-717-11	FILM	17000pF	3%	1.2KV	
\triangle	C511	1-115-522-11	FILM	1 μ F	5%	250V	
	C514	1-109-844-11	FILM	0.68 μ F	5%	250V	
\triangle	C520	1-129-722-00	FILM	0.047 μ F	5%	630V	
	C530	1-164-161-11	CERAMIC CHIP	0.0022 μ F	10%	50V	
	C548	1-104-710-11	ELECT	22 μ F		160V	
	C550	1-107-846-11	FILM	0.1 μ F	5%	250V	
\triangle	C555	1-117-629-11	FILM	2700pF	3%	1.2KV	
\triangle	C607	1-136-311-11	MYLAR	0.47 μ F	20%	125V	
\triangle	C612	1-128-717-11	ELECT	680 μ F	20%	250V	
	C615	1-130-202-00	FILM	0.022 μ F	10%	400V	
	C616	1-107-824-11	CERAMIC	220pF	5%	1KV	
	C625	1-135-412-51	ELECT	1000 μ F	20%	25V	
	C630	1-127-795-51	CERAMIC	3300pF	20%	250V	
	C631	1-113-924-11	CERAMIC	4700pF	20%	250V	
	C658	1-135-412-51	ELECT	1000 μ F	20%	25V	
<u>DIODE</u>							
	D609	8-719-311-31	DIODE RU-1P				
<u>FERRITE BEAD</u>							
	FB605	1-412-911-11	FERRITE	0 μ H			
	FB607	1-412-911-11	FERRITE	0 μ H			
	FB608	1-412-911-11	FERRITE	0 μ H			
<u>IC</u>							
	IC502	8-759-980-58	IC TDA8172				
\triangle	IC601	8-749-018-43	IC STR-F6426				
<u>COIL</u>							
	L505	1-406-978-11	INDUCTOR	150 μ H			
<u>TRANSISTOR</u>							
\triangle	Q502	8-729-046-07	TRANSISTOR 2SD2578-YB				
<u>RESISTOR</u>							
	R436	1-216-069-00	RES-CHIP	6.8K	5%	1/10W	
	R437	1-216-065-91	RES-CHIP	4.7K	5%	1/10W	
	R438	1-216-069-00	RES-CHIP	6.8K	5%	1/10W	
	R490	1-208-798-11	METAL CHIP	4.7K	1%	1/10W	
\triangle	R513	1-215-907-11	METAL OXIDE	22	5%	3W	
	R514	1-216-683-11	METAL CHIP	22K	0.50%	1/10W	
	R518	1-249-427-11	CARBON	6.8K	5%	1/4W	
	R519	1-249-427-11	CARBON	6.8K	5%	1/4W	
	R529	1-216-109-00	RES-CHIP	330K	5%	1/10W	
	R530	1-216-077-91	RES-CHIP	15K	5%	1/10W	
	R533	1-215-457-00	METAL	33K	1%	1/4W	
	R534	1-215-458-00	METAL	36K	1%	1/4W	
\triangle	\boxtimes R564	1-208-836-11	METAL CHIP	180K	0.50%	1/10W	
\triangle	R601	1-219-513-11	CARBON	4.7M	5%	1/2W	
\triangle	R626	1-220-926-11	FUSIBLE	0.47	10%	1/2W	
	R627	1-215-483-00	METAL	390K	1%	1/4W	
	R631	1-215-929-11	METAL OXIDE	100K	5%	3W	
\triangle	R632	1-216-361-00	METAL OXIDE	0.22	5%	2W	
	R638	1-249-399-11	CARBON	33	5%	1/4W	
\triangle	R641	1-216-362-11	METAL OXIDE	0.27	5%	2W	
	R646	1-249-419-11	CARBON	1.5K	5%	1/4W	
\triangle	R660	1-215-924-00	METAL OXIDE	15K	5%	3W	
<u>TRANSFORMER</u>							
\triangle	T504	1-431-693-11	TRANSFORMER, HORIZONTAL LINEAR				
\triangle	T505	1-453-310-11	FBT ASSY NX-4521//X4J4				
\triangle	T602	1-435-617-11	TRANSFORMER, LINE FILTER				
\triangle	T603	1-433-806-21	TRANSFORMER, REGULAT				
<u>THERMISTOR</u>							
\triangle	THP601	1-803-540-11	THERMISTOR				
<u>VARISTOR</u>							
\triangle	VDR601	1-803-585-11	VARISTOR ENE271D-10A				

NOTE: The components identified by shading and \triangle mark are critical for safety. Replace only with part number specified.

A component identified by this \boxtimes symbol indicates that it has been carefully factory-selected to satisfy regulations regarding X-ray radiation. Should replacement be required, replace only with the value originally used.

VARIANT PARTS LISTING



The parts on this page belong to the following model(s) only:
KV-32FS13

REF. NO.	PART NO.	DESCRIPTION	VALUES	REF. NO.	PART NO.	DESCRIPTION	VALUES
A BOARD VARIANT PARTS LIST (KV-32FS13)							
*	A-1299-516-A	A COMPLETE PC BOARD					
<u>CAPACITOR</u>							
\triangle	C507	1-117-652-11	FILM 22000pF 3% 1.2KV				
\triangle	C511	1-115-521-11	FILM 0.82μF 5% 250V				
	C514	1-115-521-11	FILM 0.82μF 5% 250V				
	C517	1-107-846-11	FILM 0.1μF 5% 250V				
\triangle	C520	1-130-118-91	FILM 0.051μF 5% 400V				
	C530	1-163-009-91	CERAMIC CHIP 0.001μF 10% 50V				
	C548	1-107-995-11	ELECT 100μF 160V				
	C550	1-117-667-11	FILM 0.47μF 5% 250V				
\triangle	C555	1-117-635-11	FILM 4700pF 3% 1.2KV				
\triangle	C607	1-136-311-11	MYLAR 0.47μF 20% 125V				
\triangle	C612	1-113-611-11	ELECT(BLOCK) 820μF 20% 250V				
	C625	1-135-412-51	ELECT 1000μF 20% 25V				
	C630	1-127-795-51	CERAMIC 3300pF 20% 250V				
	C631	1-113-924-11	CERAMIC 4700pF 20% 250V				
	C658	1-135-412-51	ELECT 1000μF 20% 25V				
<u>CONNECTOR</u>							
*	CN604	1-573-963-11	PIN,CONNECTOR (PC BOARD) 3P				
<u>FERRITE BEAD</u>							
	FB605	1-412-911-11	FERRITE 0μH				
<u>IC</u>							
	IC502	8-759-192-71	IC STV9379				
\triangle	IC601	8-749-018-43	IC STR-F6426				
<u>COIL</u>							
	L505	1-406-976-11	INDUCTOR 68μH				
<u>TRANSISTOR</u>							
\triangle	Q502	8-729-045-26	TRANSISTOR 2SD2580-YB				
<u>RESISTOR</u>							
	R436	1-216-073-91	RES-CHIP 10K 5% 1/10W				
	R437	1-216-073-91	RES-CHIP 10K 5% 1/10W				
	R438	1-216-073-91	RES-CHIP 10K 5% 1/10W				
	R490	1-216-073-91	RES-CHIP 10K 5% 1/10W				
\triangle	R513	1-215-905-11	METAL OXIDE 10 5% 3W				
	R514	1-216-071-00	RES-CHIP 8.2K 5% 1/10W				
	R518	1-215-439-00	METAL 5.6K 1% 1/4W				
	R519	1-215-439-00	METAL 5.6K 1% 1/4W				
	R529	1-216-107-00	RES-CHIP 270K 5% 1/10W				
	R530	1-208-812-11	METAL CHIP 18K 0.50% 1/10W				
	R533	1-215-453-00	METAL 22K 1% 1/4W				
	R534	1-215-457-00	METAL 33K 1% 1/4W				
	R537	1-215-373-31	METAL 10 1% 1/4W				
\triangle	\boxtimes R564	1-208-824-11	METAL CHIP 56K 1% 1/10W				
\triangle	R601	1-219-513-11	CARBON 4.7M 5% 1/2W				
\triangle	R626	1-202-933-61	FUSIBLE 0.1 10% 1/2W				
	R627	1-215-483-00	METAL 390K 1% 1/4W				
\triangle	R632	1-217-611-00	METAL 0.1 10% 2W				
	R638	1-249-399-11	CARBON 33 5% 1/4W				
\triangle	R641	1-216-369-00	METAL OXIDE 1 5% 2W				
	R646	1-249-419-11	CARBON 1.5K 5% 1/4W				
\triangle	R660	1-215-924-00	METAL OXIDE 15K 5% 3W				
<u>TRANSFORMER</u>							
\triangle	T504	1-435-098-11	TRANSFORMER, HORIZONTAL LINEAR				
\triangle	T505	1-453-338-11	FBT ASSY, NX-4600//X4J4				
\triangle	T602	1-435-617-11	TRANSFORMER, LINE FILTER				
\triangle	T603	1-435-403-11	TRANSFORMER, CONVERTER (S.R.T)				
<u>THERMISTOR</u>							
\triangle	THP601	1-803-629-11	THERMISTOR, POSITIVE				
<u>VARISTOR</u>							
\triangle	VDR601	1-803-585-11	VARISTOR ENE271D-10A				

NOTE: The components identified by shading and \triangle mark are critical for safety. Replace only with part number specified.

A component identified by this \boxtimes symbol indicates that it has been carefully factory-selected to satisfy regulations regarding X-ray radiation. Should replacement be required, replace only with the value originally used.

VARIANT PARTS LISTING



The parts on this page belong to the following model(s) only:
KV-32FS17/34FS17

REF. NO.	PART NO.	DESCRIPTION	VALUES	REF. NO.	PART NO.	DESCRIPTION	VALUES
A BOARD VARIANT PARTS LIST (KV-32FS17/34FS17)							
*	A-1299-504-A	A COMPLETE PC BOARD					
CAPACITOR							
\triangle	C507	1-117-652-11	FILM 22000pF 3% 1.2KV				
\triangle	C511	1-115-521-11	FILM 0.82 μ F 5% 250V				
	C514	1-115-521-11	FILM 0.82 μ F 5% 250V				
	C517	1-107-846-11	FILM 0.1 μ F 5% 250V				
\triangle	C520	1-130-118-91	FILM 0.051 μ F 5% 400V				
	C530	1-163-009-91	CERAMIC CHIP 0.001 μ F 10% 50V				
	C548	1-107-995-11	ELECT 100 μ F 160V				
	C550	1-117-667-11	FILM 0.47 μ F 5% 250V				
\triangle	C555	1-117-635-11	FILM 4700pF 3% 1.2KV				
\triangle	C607	1-136-311-11	MYLAR 0.47 μ F 20% 125V				
\triangle	C612	1-113-611-11	ELECT(BLOCK) 820 μ F 20% 250V				
	C625	1-135-412-51	ELECT 1000 μ F 20% 25V				
	C630	1-127-795-51	CERAMIC 3300pF 20% 250V				
	C631	1-113-924-11	CERAMIC 4700pF 20% 250V				
	C658	1-135-412-51	ELECT 1000 μ F 20% 25V				
CONNECTOR							
*	CN604	1-573-963-11	PIN,CONNECTOR (PC BOARD) 3P				
FERRITE BEAD							
	FB605	1-412-911-11	FERRITE 0 μ H				
	FB607	1-412-911-11	FERRITE 0 μ H				
	FB608	1-412-911-11	FERRITE 0 μ H				
IC							
	IC502	8-759-192-71	IC STV9379				
\triangle	IC601	8-749-018-43	IC STR-F6426				
COIL							
	L505	1-406-976-11	INDUCTOR 68 μ H				
TRANSISTOR							
\triangle	Q502	8-729-045-26	TRANSISTOR 2SD2580-YB				
RESISTOR							
	R436	1-216-073-91	RES-CHIP 10K 5% 1/10W				
	R437	1-216-073-91	RES-CHIP 10K 5% 1/10W				
	R438	1-216-073-91	RES-CHIP 10K 5% 1/10W				
	R490	1-216-073-91	RES-CHIP 10K 5% 1/10W				
\triangle	R513	1-215-905-11	METAL OXIDE 10 5% 3W				
	R514	1-216-071-00	RES-CHIP 8.2K 5% 1/10W				
	R518	1-215-439-00	METAL 5.6K 1% 1/4W				
	R519	1-215-439-00	METAL 5.6K 1% 1/4W				
	R529	1-216-107-00	RES-CHIP 270K 5% 1/10W				
	R530	1-208-812-11	METAL CHIP 18K 0.50% 1/10W				
	R533	1-215-453-00	METAL 22K 1% 1/4W				
	R534	1-215-457-00	METAL 33K 1% 1/4W				
	R537	1-215-373-31	METAL 10 1% 1/4W				
\triangle	\boxtimes R564	1-208-824-11	METAL CHIP 56K 0.50% 1/10W				
\triangle	R601	1-219-513-11	CARBON 4.7M 5% 1/2W				
\triangle	R626	1-202-933-61	FUSIBLE 0.1 10% 1/2W				
	R627	1-215-483-00	METAL 390K 1% 1/4W				
\triangle	R632	1-217-611-00	METAL 0.1 10% 2W				
	R638	1-249-399-11	CARBON 33 5% 1/4W				
\triangle	R641	1-216-369-00	METAL OXIDE 1 5% 2W				
	R646	1-249-419-11	CARBON 1.5K 5% 1/4W				
\triangle	R660	1-215-924-00	METAL OXIDE 15K 5% 3W				
TRANSFORMER							
\triangle	T504	1-435-098-11	TRANSFORMER, HORIZONTAL LINEAR				
\triangle	T505	1-453-338-11	FBT ASSY, NX-4600//X4J4				
\triangle	T602	1-435-617-11	TRANSFORMER, LINE FILTER				
\triangle	T603	1-435-403-11	TRANSFORMER, CONVERTER (S.R.T)				
THERMISTOR							
\triangle	THP601	1-803-629-11	THERMISTOR, POSITIVE				
VARISTOR							
\triangle	VDR601	1-803-585-11	VARISTOR ENE271D-10A				

NOTE: The components identified by shading and \triangle mark are critical for safety. Replace only with part number specified.

A component identified by this \boxtimes symbol indicates that it has been carefully factory-selected to satisfy regulations regarding X-ray radiation. Should replacement be required, replace only with the value originally used.

VARIANT PARTS LISTING



The parts on this page belong to the following model(s) only:
KV-34FS13C

REF. NO.	PART NO.	DESCRIPTION	VALUES	REF. NO.	PART NO.	DESCRIPTION	VALUES
A BOARD VARIANT PARTS LIST (KV-34FS13C)							
*	A-1299-506-A	A COMPLETE PC BOARD		R530	1-208-812-11	METAL CHIP	18K 0.50% 1/10W
	CAPACITOR			R533	1-215-453-00	METAL	22K 1% 1/4W
\triangle	C507	1-117-652-11	FILM 22000pF 3% 1.2KV	R534	1-215-457-00	METAL	33K 1% 1/4W
\triangle	C511	1-115-521-11	FILM 0.82 μ F 5% 250V	R537	1-215-373-31	METAL	10 1% 1/4W
	C514	1-115-521-11	FILM 0.82 μ F 5% 250V	\triangle \boxtimes R564	1-208-824-11	METAL CHIP	56K 0.50% 1/10W
	C517	1-107-846-11	FILM 0.1 μ F 5% 250V	\triangle	R615	1-218-265-11	METAL 8.2M 5% 1W
\triangle	C520	1-130-118-91	FILM 0.051 μ F 5% 400V	\triangle	R626	1-202-933-61	FUSIBLE 0.1 10% 1/2W
	C530	1-163-009-91	CERAMIC CHIP 0.001 μ F 10% 50V	R627	1-215-479-00	METAL	270K 1% 1/4W
	C548	1-107-995-11	ELECT 100 μ F 160V	R628	1-215-479-00	METAL	270K 1% 1/4W
	C550	1-117-667-11	FILM 0.47 μ F 5% 250V	R629	1-215-929-11	METAL OXIDE	100K 5% 3W
\triangle	C555	1-117-635-11	FILM 4700pF 3% 1.2KV	\triangle	R632	1-217-611-00	METAL 0.1 10% 2W
	C615	1-130-202-00	FILM 0.022 μ F 10% 400V	\triangle	R637	1-216-485-11	METAL OXIDE 5.6K 5% 3W
	C616	1-107-824-11	CERAMIC 220pF 5% 1KV	R638	1-249-402-11	CARBON	56 5% 1/4W
	C625	1-135-572-51	ELECT 1000 μ F 20% 50V	\triangle	R641	1-216-369-00	METAL OXIDE 1 5% 2W
	C658	1-135-572-51	ELECT 1000 μ F 20% 50V	R646	1-249-418-11	CARBON	1.2K 5% 1/4W
\triangle	C660	1-128-714-11	ELECT 330 μ F 20% 400V	\triangle	R660	1-216-485-11	METAL OXIDE 5.6K 5% 3W
\triangle	C661	1-128-714-11	ELECT 330 μ F 20% 400V	\triangle	R662	1-216-485-11	METAL OXIDE 5.6K 5% 3W
	CONNECTOR			TRANSFORMER			
*	CN604	1-573-963-11	PIN,CONNECTOR (PC BOARD) 3P	\triangle	T504	1-435-098-11	TRANSFORMER, HORIZONTAL LINEAR
	DIODE			\triangle	T505	1-453-338-11	FBT ASSY, NX-4600//X4J4
	D609	8-719-311-31	DIODE RU-1P	\triangle	T602	1-426-717-11	TRANSFORMER, LINE FILTER (LFT)
	FERRITE BEAD			\triangle	T603	1-435-402-11	TRANSFORMER, CONVERTER (SRT)
	FB605	1-410-397-21	FERRITE 1.1 μ H	THERMISTOR			
	IC			\triangle	THP601	1-803-540-11	THERMISTOR
	IC502	8-759-192-71	IC STV9379	VARISTOR			
\triangle	IC601	8-749-014-48	IC STR-F6656	\triangle	VDR601	1-803-967-11	VARISTOR (ENE621D-14A)
	COIL						
	L505	1-406-976-11	INDUCTOR 68 μ H				
	TRANSISTOR						
\triangle	Q502	8-729-045-26	TRANSISTOR 2SD2580-YB				
	RESISTOR						
	R436	1-216-073-91	RES-CHIP 10K 5% 1/10W				
	R437	1-216-073-91	RES-CHIP 10K 5% 1/10W				
	R438	1-216-073-91	RES-CHIP 10K 5% 1/10W				
	R490	1-216-073-91	RES-CHIP 10K 5% 1/10W				
\triangle	R513	1-215-905-11	METAL OXIDE 10 5% 3W				
	R514	1-216-071-00	RES-CHIP 8.2K 5% 1/10W				
	R518	1-215-439-00	METAL 5.6K 1% 1/4W				
	R519	1-215-439-00	METAL 5.6K 1% 1/4W				
	R529	1-216-107-00	RES-CHIP 270K 5% 1/10W				

NOTE: The components identified by shading and \triangle mark are critical for safety. Replace only with part number specified.

NOTE: Les composants identifiés par un trame et une marque \triangle sont critiques pour la sécurité. Ne les remplacer que par une pièce portant le numéro spécifique.

VARIANT PARTS LISTING



The parts on this page belong to the following model(s) only:
KV-27FV17

REF. NO.	PART NO.	DESCRIPTION	VALUES			REF. NO.	PART NO.	DESCRIPTION	VALUES		
A BOARD VARIANT PARTS LIST (KV-27FV17)											
*	A-1299-243-A	A COMPLETE PC BOARD									
<u>CAPACITOR</u>											
\triangle	C607	1-136-311-11	MYLAR	0.47 μ F	20%	125V					
\triangle	C612	1-113-611-11	ELECT(BLOCK)	820 μ F	20%	250V					
	C630	1-113-923-11	CERAMIC	0.0033 μ F	20%	250V					
	C631	1-113-924-11	CERAMIC	0.0047 μ F	20%	250V					
<u>FUSE</u>											
\triangle	F601	1-576-193-11	FUSE	6.3A/125V							
<u>IC</u>											
\triangle	IC601	8-749-018-43	IC STR-F6426								
<u>RESISTOR</u>											
	R218	1-216-049-11	RES-CHIP	1K	5%	1/10W					
\triangle	R601	1-219-513-11	CARBON	4.7M	5%	1/2W					
	R627	1-215-483-00	METAL	390K	1%	1/4W					
	R631	1-215-929-11	METAL OXIDE	100K	5%	3W					
	R638	1-249-399-11	CARBON	33	5%	1/4W					
	R646	1-249-419-11	CARBON	1.5K	5%	1/4W					
\triangle	R660	1-215-924-00	METAL OXIDE	15K	5%	3W					
<u>TRANSFORMER</u>											
\triangle	T602	1-435-617-11	TRANSFORMER, LINE FILTER								
\triangle	T603	1-435-403-11	TRANSFORMER, CONVERTER (S.R.T)								
<u>VARISTOR</u>											
\triangle	VDR601	1-803-585-11	VARISTOR ENE271D-10A								









NOTE: The components identified by shading and  mark are critical for safety. Replace only with part number specified.

NOTE: Les composants identifiés par un trame et une marque  sont critiques pour la securite. Ne les remplacer que par une piece portant le numero specifique.

VARIANT PARTS LISTING



The parts on this page belong to the following model(s) only:
KV-29FV17

REF. NO.	PART NO.	DESCRIPTION	VALUES			REF. NO.	PART NO.	DESCRIPTION	VALUES		
A BOARD VARIANT PARTS LIST (KV-29FV17)											
*	A-1299-498-A	A COMPLETE PC BOARD									
<u>CAPACITOR</u>											
	C607	1-136-311-11	MYLAR	0.47μF	20%	125V					
	C612	1-113-611-11	ELECT(BLOCK)	820μF	20%	250V					
<u>FUSE</u>											
	F601	1-576-193-11	FUSE 6.3A/125V								
<u>IC</u>											
	IC601	8-749-018-43	IC STR-F6426								
<u>RESISTOR</u>											
	R218	1-208-758-11	METAL CHIP	100	0.50%	1/10W					
	R601	1-219-513-11	CARBON	4.7M	5%	1/2W					
	R627	1-215-483-00	METAL	390K	1%	1/4W					
	R631	1-215-929-11	METAL OXIDE	100K	5%	3W					
	R638	1-249-399-11	CARBON	33	5%	1/4W					
	R646	1-249-419-11	CARBON	1.5K	5%	1/4W					
	R660	1-215-924-00	METAL OXIDE	15K	5%	3W					
<u>TRANSFORMER</u>											
	T602	1-426-717-11	TRANSFORMER, LINE FILTER (LFT)								
	T603	1-435-403-11	TRANSFORMER, CONVERTER (S.R.T)								
<u>VARISTOR</u>											
	VDR601	1-803-585-11	VARISTOR ENE271D-10A								











NOTE: The components identified by shading and  mark are critical for safety. Replace only with part number specified.

NOTE: Les composants identifiés par un trame et une marque  sont critiques pour la sécurité. Ne les remplacer que par une pièce portant le numéro spécifique.

VARIANT PARTS LISTING



The parts on this page belong to the following model(s) only:
KV-29FV17C

REF. NO.	PART NO.	DESCRIPTION	VALUES			REF. NO.	PART NO.	DESCRIPTION	VALUES		
A BOARD VARIANT PARTS LIST (KV-29FV17C)											
*	A-1299-244-A	A COMPLETE PC BOARD									
<u>CAPACITOR</u>											
	C660	1-128-714-11	ELECT	330µF	20%	400V					
	C661	1-128-714-11	ELECT	330µF	20%	400V					
<u>FUSE</u>											
	F601	1-532-506-51	FUSE 6.3A/250V								
<u>IC</u>											
	IC601	8-749-018-44	IC STR-F6456								
<u>RESISTOR</u>											
	R218	1-216-049-11	RES-CHIP	1K	5%	1/10W					
	R615	1-218-265-11	METAL	8.2M	5%	1W					
	R627	1-215-479-00	METAL	270K	1%	1/4W					
	R637	1-216-485-11	METAL OXIDE	5.6K	5%	3W					
	R638	1-249-402-11	CARBON	56	5%	1/4W					
	R646	1-249-418-11	CARBON	1.2K	5%	1/4W					
	R660	1-216-485-11	METAL OXIDE	5.6K	5%	3W					
	R662	1-216-485-11	METAL OXIDE	5.6K	5%	3W					
<u>TRANSFORMER</u>											
	T602	1-426-717-11	TRANSFORMER, LINE FILTER (LFT)								
	T603	1-435-402-11	TRANSFORMER, CONVERTER (SRT)								
<u>VARISTOR</u>											
	VDR601	1-803-967-11	VARISTOR (ENE621D-14A)								



COMMON PARTS LISTING FS SERIES

REF. NO.	PART NO.	DESCRIPTION	VALUES	REF. NO.	PART NO.	DESCRIPTION	VALUES
JR355	1-216-295-91	SHORT		Q369	8-729-424-02	TRANSISTOR 2SB709A-QRS-TX	
JR378	1-216-295-91	SHORT		Q370	8-729-424-02	TRANSISTOR 2SB709A-QRS-TX	
JR379	1-216-295-91	SHORT		Q375	8-729-422-27	TRANSISTOR 2SD601A-QRS-TX	
JR391	1-216-295-91	SHORT		Q378		VARIANT (SEE VARIANT PARTS LIST)	
JR399	1-216-295-91	SHORT		Q379		VARIANT (SEE VARIANT PARTS LIST)	
JR402	1-216-295-91	SHORT		Q380		VARIANT (SEE VARIANT PARTS LIST)	
JR501	1-216-295-91	SHORT		Q387	8-729-424-02	TRANSISTOR 2SB709A-QRS-TX	
JR502	1-216-295-91	SHORT		Q388	8-729-424-02	TRANSISTOR 2SB709A-QRS-TX	
				Q389	8-729-424-02	TRANSISTOR 2SB709A-QRS-TX	
	COIL				RESISTOR		
L002	1-412-064-11	INDUCTOR	100μH	R001	1-216-043-91	RES-CHIP	560 5% 1/10W
L003	1-412-064-11	INDUCTOR	100μH	R002	1-216-041-00	RES-CHIP	470 5% 1/10W
L040	1-408-963-11	INDUCTOR	2.7μH	R003	1-247-807-31	CARBON	100 5% 1/4W
L150		VARIANT (SEE VARIANT PARTS LIST)		R004	1-216-061-91	RES-CHIP	3.3K 5% 1/10W
L151		VARIANT (SEE VARIANT PARTS LIST)		R005	1-216-295-91	SHORT	
L301	1-412-029-11	INDUCTOR	10μH	R006	1-216-025-11	RES-CHIP	100 5% 1/10W
L302	1-412-031-11	INDUCTOR	47μH	R007	1-216-025-11	RES-CHIP	100 5% 1/10W
L303	1-414-856-11	INDUCTOR	10μH	R008	1-216-049-11	RES-CHIP	1K 5% 1/10W
L304	1-414-856-11	INDUCTOR	10μH	R009	1-216-121-11	RES-CHIP	1M 5% 1/10W
L305	1-412-029-11	INDUCTOR	10μH	R010	1-216-033-00	RES-CHIP	220 5% 1/10W
L308	1-412-064-11	INDUCTOR	100μH	R011	1-216-033-00	RES-CHIP	220 5% 1/10W
L310	1-412-064-11	INDUCTOR	100μH	R012	1-216-045-00	RES-CHIP	680 5% 1/10W
L350	1-414-856-11	INDUCTOR	10μH	R013	1-249-417-11	CARBON	1K 5% 1/4W
L351	1-414-856-11	INDUCTOR	10μH	R014	1-216-073-91	RES-CHIP	10K 5% 1/10W
	TRANSISTOR			R015	1-216-073-91	RES-CHIP	10K 5% 1/10W
Q001	8-729-424-02	TRANSISTOR 2SB709A-QRS-TX		R016	1-216-041-00	RES-CHIP	470 5% 1/10W
Q002	8-729-422-27	TRANSISTOR 2SD601A-QRS-TX		R017	1-208-798-11	METAL	4.7K 0.50% 1/10W
Q003	8-729-422-27	TRANSISTOR 2SD601A-QRS-TX		R018	1-249-409-11	CARBON	220 5% 1/4W
Q004	8-729-424-02	TRANSISTOR 2SB709A-QRS-TX		R019	1-216-113-00	RES-CHIP	470K 5% 1/10W
Q006	8-729-424-02	TRANSISTOR 2SB709A-QRS-TX		R020	1-216-033-00	RES-CHIP	220 5% 1/10W
Q082	8-729-422-27	TRANSISTOR 2SD601A-QRS-TX		R021	1-216-073-91	RES-CHIP	10K 5% 1/10W
Q151		VARIANT (SEE VARIANT PARTS LIST)		R022	1-249-409-11	CARBON	220 5% 1/4W
Q152		VARIANT (SEE VARIANT PARTS LIST)		R023	1-249-429-11	CARBON	10K 5% 1/4W
Q302	8-729-422-27	TRANSISTOR 2SD601A-QRS-TX		R024	1-249-409-11	CARBON	220 5% 1/4W
Q303	8-729-424-02	TRANSISTOR 2SB709A-QRS-TX		R025	1-249-426-11	CARBON	5.6K 5% 1/4W
Q305	8-729-424-02	TRANSISTOR 2SB709A-QRS-TX		R026	1-249-426-11	CARBON	5.6K 5% 1/4W
Q310	8-729-424-02	TRANSISTOR 2SB709A-QRS-TX		R027	1-249-426-11	CARBON	5.6K 5% 1/4W
Q349	8-729-422-27	TRANSISTOR 2SD601A-QRS-TX		R028	1-216-049-11	RES-CHIP	1K 5% 1/10W
Q350	8-729-424-02	TRANSISTOR 2SB709A-QRS-TX		R029	1-216-065-91	RES-CHIP	4.7K 5% 1/10W
Q351	8-729-424-02	TRANSISTOR 2SB709A-QRS-TX		R030	1-216-065-91	RES-CHIP	4.7K 5% 1/10W
Q352	8-729-422-27	TRANSISTOR 2SD601A-QRS-TX		R031	1-216-355-11	METAL	3.3 5% 1W
Q354	8-729-424-02	TRANSISTOR 2SB709A-QRS-TX		R032	1-216-033-00	RES-CHIP	220 5% 1/10W
Q355	8-729-424-02	TRANSISTOR 2SB709A-QRS-TX		R033	1-216-033-00	RES-CHIP	220 5% 1/10W
Q356	8-729-422-27	TRANSISTOR 2SD601A-QRS-TX		R034	1-216-033-00	RES-CHIP	220 5% 1/10W
Q358	8-729-422-27	TRANSISTOR 2SD601A-QRS-TX		R035	1-216-033-00	RES-CHIP	220 5% 1/10W
Q359	8-729-424-02	TRANSISTOR 2SB709A-QRS-TX		R036	1-216-049-11	RES-CHIP	1K 5% 1/10W
Q365	8-729-422-27	TRANSISTOR 2SD601A-QRS-TX		R037	1-249-409-11	CARBON	220 5% 1/4W
Q368	8-729-422-27	TRANSISTOR 2SD601A-QRS-TX		R038	1-216-049-11	RES-CHIP	1K 5% 1/10W



COMMON PARTS LISTING FS SERIES

REF. NO.	PART NO.	DESCRIPTION	VALUES			REF. NO.	PART NO.	DESCRIPTION	VALUES		
R039	1-216-045-00	RES-CHIP	680	5%	1/10W	R159		VARIANT (SEE VARIANT PARTS LIST)			
R040	1-249-409-11	CARBON	220	5%	1/4W	R251	1-216-065-91	RES-CHIP	4.7K	5%	1/10W
R041	1-216-045-00	RES-CHIP	680	5%	1/10W	R253	1-216-049-11	RES-CHIP	1K	5%	1/10W
R042	1-216-071-00	RES-CHIP	8.2K	5%	1/10W	R256	1-216-073-91	RES-CHIP	10K	5%	1/10W
R043	1-249-417-11	CARBON	1K	5%	1/4W	R257	1-216-049-11	RES-CHIP	1K	5%	1/10W
R044	1-216-033-00	RES-CHIP	220	5%	1/10W	R258	1-216-065-91	RES-CHIP	4.7K	5%	1/10W
R045	1-216-065-91	RES-CHIP	4.7K	5%	1/10W	R259	1-249-429-11	CARBON	10K	5%	1/4W
R046	1-216-033-00	RES-CHIP	220	5%	1/10W	R260	1-249-409-11	CARBON	220	5%	1/4W
R047	1-216-065-91	RES-CHIP	4.7K	5%	1/10W	R261	1-216-113-00	RES-CHIP	470K	5%	1/10W
R048		VARIANT (SEE VARIANT PARTS LIST)				R262	1-247-807-31	CARBON	100	5%	1/4W
R050	1-216-033-00	RES-CHIP	220	5%	1/10W	R263	1-216-025-11	RES-CHIP	100	5%	1/10W
R051	1-216-033-00	RES-CHIP	220	5%	1/10W	R264		VARIANT (SEE VARIANT PARTS LIST)			
R052	1-249-417-11	CARBON	1K	5%	1/4W	R266		VARIANT (SEE VARIANT PARTS LIST)			
R054	1-216-065-91	RES-CHIP	4.7K	5%	1/10W	R267	1-216-049-11	RES-CHIP	1K	5%	1/10W
R055	1-216-065-91	RES-CHIP	4.7K	5%	1/10W	R268	1-216-045-00	RES-CHIP	680	5%	1/10W
R056	1-208-798-11	METAL	4.7K	0.50%	1/10W	R269	1-216-049-11	RES-CHIP	1K	5%	1/10W
R057	1-216-097-11	RES-CHIP	100K	5%	1/10W	R270		VARIANT (SEE VARIANT PARTS LIST)			
R058	1-216-097-11	RES-CHIP	100K	5%	1/10W	R271		VARIANT (SEE VARIANT PARTS LIST)			
R060	1-249-409-11	CARBON	220	5%	1/4W	R272		VARIANT (SEE VARIANT PARTS LIST)			
R061	1-216-033-00	RES-CHIP	220	5%	1/10W	R273	1-216-073-91	RES-CHIP	10K	5%	1/10W
R064	1-216-295-91	SHORT				R274	1-216-295-91	SHORT			
R069		VARIANT (SEE VARIANT PARTS LIST)				R275	1-216-081-00	RES-CHIP	22K	5%	1/10W
R070	1-216-065-91	RES-CHIP	4.7K	5%	1/10W	R276	1-216-085-91	RES-CHIP	33K	5%	1/10W
R071	1-216-065-91	RES-CHIP	4.7K	5%	1/10W	R277		VARIANT (SEE VARIANT PARTS LIST)			
R073	1-249-425-11	CARBON	4.7K	5%	1/4W	R279	1-247-807-31	CARBON	100	5%	1/4W
R074	1-216-065-91	RES-CHIP	4.7K	5%	1/10W	R280	1-216-069-00	RES-CHIP	6.8K	5%	1/10W
R077	1-216-097-11	RES-CHIP	100K	5%	1/10W	R281	1-208-798-11	METAL	4.7K	0.50%	1/10W
R086	1-216-045-00	RES-CHIP	680	5%	1/10W	R282	1-208-790-11	METAL	2.2K	0.50%	1/10W
R087	1-216-045-00	RES-CHIP	680	5%	1/10W	R283	1-216-689-11	RES-CHIP	39K	5%	1/10W
R088	1-216-045-00	RES-CHIP	680	5%	1/10W	R300	1-216-295-91	SHORT			
R091	1-216-073-91	RES-CHIP	10K	5%	1/10W	R301	1-216-022-00	RES-CHIP	75	5%	1/10W
R092	1-208-798-11	METAL	4.7K	0.50%	1/10W	R303	1-216-073-91	RES-CHIP	10K	5%	1/10W
R093	1-216-065-91	RES-CHIP	4.7K	5%	1/10W	R304	1-247-807-31	CARBON	100	5%	1/4W
R094	1-216-065-91	RES-CHIP	4.7K	5%	1/10W	R305	1-216-295-91	SHORT			
R095	1-216-065-91	RES-CHIP	4.7K	5%	1/10W	R306	1-216-025-11	RES-CHIP	100	5%	1/10W
R096	1-216-065-91	RES-CHIP	4.7K	5%	1/10W	R308	1-216-022-00	RES-CHIP	75	5%	1/10W
R097	1-249-414-11	CARBON	560	5%	1/4W	R310	1-249-417-11	CARBON	1K	5%	1/4W
R099	1-216-089-91	RES-CHIP	47K	5%	1/10W	R311	1-216-025-11	RES-CHIP	100	5%	1/10W
R100		VARIANT (SEE VARIANT PARTS LIST)				R312	1-249-417-11	CARBON	1K	5%	1/4W
R101		VARIANT (SEE VARIANT PARTS LIST)				R313	1-216-049-11	RES-CHIP	1K	5%	1/10W
R150		VARIANT (SEE VARIANT PARTS LIST)				R314		VARIANT (SEE VARIANT PARTS LIST)			
R151		VARIANT (SEE VARIANT PARTS LIST)				R316	1-216-067-00	RES-CHIP	5.6K	5%	1/10W
R154		VARIANT (SEE VARIANT PARTS LIST)				R317	1-247-807-31	CARBON	100	5%	1/4W
R155		VARIANT (SEE VARIANT PARTS LIST)				R318	1-216-091-00	RES-CHIP	56K	5%	1/10W
R156		VARIANT (SEE VARIANT PARTS LIST)				R319	1-216-081-00	RES-CHIP	22K	5%	1/10W
R157		VARIANT (SEE VARIANT PARTS LIST)				R320	1-216-025-11	RES-CHIP	100	5%	1/10W
R158		VARIANT (SEE VARIANT PARTS LIST)				R321	1-216-043-91	RES-CHIP	560	5%	1/10W

VARIANT PARTS LISTING

MA

The parts on this page belong to the following model(s) only: KV-27FS13

REF. NO.	PART NO.	DESCRIPTION	VALUES	REF. NO.	PART NO.	DESCRIPTION	VALUES
MA BOARD VARIANT PARTS LIST (KV-27FS13)							
*	A-1304-200-A	MA (VAR) MOUNTED PC BOARD					
		<u>CAPACITOR</u>					
C380	1-163-021-91	CERAMIC CHIP	0.01 μ F 10% 50V				
C381	1-163-021-91	CERAMIC CHIP	0.01 μ F 10% 50V				
C382	1-163-021-91	CERAMIC CHIP	0.01 μ F 10% 50V				
C389	1-115-185-11	CERAMIC CHIP	0.033 μ F 10% 50V				
		<u>RESISTOR</u>					
R277	1-216-129-00	RES-CHIP	2.2M 5% 1/10W				
R398	1-216-091-00	RES-CHIP	56K 5% 1/10W				
R399	1-216-109-00	RES-CHIP	330K 5% 1/10W				

NOTE: The components identified by shading and \triangle mark are critical for safety. Replace only with part number specified.

NOTE: Les composants identifiés par un trame et une marque \triangle sont critiques pour la sécurité. Ne les remplacer que par une pièce portant le numéro spécifique.

VARIANT PARTS LISTING

The parts on this page belong to the following model(s) only:
KV-27FS17

REF. NO.	PART NO.	DESCRIPTION	VALUES			REF. NO.	PART NO.	DESCRIPTION	VALUES		
MA BOARD VARIANT PARTS LIST (KV-27FS17)						R158	1-216-025-11	RES-CHIP	100	5%	1/10W
	A-1304-198-A	MA (VAR) MOUNTED PC BOARD				R159	1-216-025-11	RES-CHIP	100	5%	1/10W
	CAPACITOR					R264	1-216-081-00	RES-CHIP	22K	5%	1/10W
C005	1-164-005-11	CERAMIC CHIP	0.47 μ F		25V	R266	1-216-081-00	RES-CHIP	22K	5%	1/10W
C151	1-126-960-11	ELECT	1 μ F	20%	50V	R270	1-216-081-00	RES-CHIP	22K	5%	1/10W
C153	1-163-017-00	CERAMIC CHIP	0.0047 μ F	10%	50V	R271	1-216-081-00	RES-CHIP	22K	5%	1/10W
C154	1-126-967-11	ELECT	47 μ F	20%	50V	R272	1-216-081-00	RES-CHIP	22K	5%	1/10W
C155	1-126-964-11	ELECT	10 μ F	20%	50V	R277	1-216-129-00	RES-CHIP	2.2M	5%	1/10W
C156	1-104-664-11	ELECT	47 μ F	20%	25V	R314	1-216-081-00	RES-CHIP	22K	5%	1/10W
C157	1-126-968-11	ELECT	100 μ F	20%	50V	R398	1-216-091-00	RES-CHIP	56K	5%	1/10W
C345	1-163-021-91	CERAMIC CHIP	0.01 μ F	10%	50V	R399	1-216-109-00	RES-CHIP	330K	5%	1/10W
C346	1-163-021-91	CERAMIC CHIP	0.01 μ F	10%	50V	R434	1-216-065-91	RES-CHIP	4.7K	5%	1/10W
C347	1-163-021-91	CERAMIC CHIP	0.01 μ F	10%	50V	R435	1-216-065-91	RES-CHIP	4.7K	5%	1/10W
C364	1-164-004-11	CERAMIC CHIP	0.1 μ F	10%	25V	TUNER					
C389	1-115-185-11	CERAMIC CHIP	0.033 μ F	10%	50V	\triangle TU150	8-598-501-30	TUNER, FSS BTF-FA402			
C451	1-163-038-91	CERAMIC CHIP	0.1 μ F		25V						
C452	1-163-038-91	CERAMIC CHIP	0.1 μ F		25V						
C453	1-163-038-91	CERAMIC CHIP	0.1 μ F		25V						
C454	1-163-038-91	CERAMIC CHIP	0.1 μ F		25V						
CONNECTOR											
* CN304	1-564-507-11	PLUG,CONNECTOR 4P									
* CN305	1-573-298-21	CONNECTOR, BOARD TO BOARD 20P									
* CN401	1-564-505-11	PLUG,CONNECTOR 2P									
DIODE											
D303	8-719-991-33	DIODE 1SS133T-77									
COIL											
L150	1-412-058-11	INDUCTOR	10 μ H								
L151	1-412-064-11	INDUCTOR	100 μ H								
TRANSISTOR											
Q151	8-729-424-02	TRANSISTOR 2SB709A-QRS-TX									
Q152	8-729-422-27	TRANSISTOR 2SD601A-QRS-TX									
Q378	8-729-424-02	TRANSISTOR 2SB709A-QRS-TX									
Q379	8-729-424-02	TRANSISTOR 2SB709A-QRS-TX									
Q380	8-729-424-02	TRANSISTOR 2SB709A-QRS-TX									
RESISTOR											
R048	1-216-025-11	RES-CHIP	100	5%	1/10W						
R069	1-249-409-11	CARBON	220	5%	1/4W						
R100	1-216-295-91	SHORT									
R101	1-216-295-91	SHORT									
R150	1-216-053-00	RES-CHIP	1.5K	5%	1/10W						
R151	1-216-025-11	RES-CHIP	100	5%	1/10W						
R154	1-216-043-91	RES-CHIP	560	5%	1/10W						
R155	1-216-043-91	RES-CHIP	560	5%	1/10W						
R156	1-216-085-91	RES-CHIP	33K	5%	1/10W						
R157	1-216-081-00	RES-CHIP	22K	5%	1/10W						

VARIANT PARTS LISTING

MA

The parts on this page belong to the following model(s) only:

KV-32FS13/34FS13C

REF. NO.	PART NO.	DESCRIPTION	VALUES			REF. NO.	PART NO.	DESCRIPTION	VALUES		
MA BOARD VARIANT PARTS LIST (KV-32FS13/34FS13C)											
*	A-1304-203-A	MA (VAR) MOUNTED PC BOARD									
<u>CAPACITOR</u>											
C380	1-163-021-91	CERAMIC CHIP	0.01 μ F	10%	50V						
C381	1-163-021-91	CERAMIC CHIP	0.01 μ F	10%	50V						
C382	1-163-021-91	CERAMIC CHIP	0.01 μ F	10%	50V						
C389	1-104-760-11	CERAMIC CHIP	0.047 μ F	10%	50V						
<u>RESISTOR</u>											
R277	1-216-133-91	RES-CHIP	3.3M	5%	1/10W						
R398	1-216-109-00	RES-CHIP	330K	5%	1/10W						
R399	1-216-689-11	RES-CHIP	39K	5%	1/10W						

NOTE: The components identified by shading and \triangle mark are critical for safety. Replace only with part number specified.

NOTE: Les composants identifiés par un trame et une marque \triangle sont critiques pour la sécurité. Ne les remplacer que par une pièce portant le numéro spécifique.

VARIANT PARTS LISTING

The parts on this page belong to the following model(s) only:
KV-32FS17/34FS17

REF. NO.	PART NO.	DESCRIPTION	VALUES			REF. NO.	PART NO.	DESCRIPTION	VALUES		
MA BOARD VARIANT PARTS LIST (KV-32FS17/34FS17)						R157	1-216-081-00	RES-CHIP	22K	5%	1/10W
A-1304-196-A MA (VAR) MOUNTED PC BOARD						R158	1-216-025-11	RES-CHIP	100	5%	1/10W
						CAPACITOR					
C005	1-164-005-11	CERAMIC CHIP	0.47 μ F		25V	R264	1-216-081-00	RES-CHIP	22K	5%	1/10W
C151	1-126-960-11	ELECT	1 μ F	20%	50V	R266	1-216-081-00	RES-CHIP	22K	5%	1/10W
C153	1-163-017-00	CERAMIC CHIP	0.0047 μ F	10%	50V	R270	1-216-081-00	RES-CHIP	22K	5%	1/10W
C154	1-126-967-11	ELECT	47 μ F	20%	50V	R271	1-216-081-00	RES-CHIP	22K	5%	1/10W
C155	1-126-964-11	ELECT	10 μ F	20%	50V	R272	1-216-081-00	RES-CHIP	22K	5%	1/10W
C156	1-104-664-11	ELECT	47 μ F	20%	25V	R277	1-216-133-91	RES-CHIP	3.3M	5%	1/10W
C157	1-126-968-11	ELECT	100 μ F	20%	50V	R314	1-216-081-00	RES-CHIP	22K	5%	1/10W
C345	1-163-021-91	CERAMIC CHIP	0.01 μ F	10%	50V	R398	1-216-109-00	RES-CHIP	330K	5%	1/10W
C346	1-163-021-91	CERAMIC CHIP	0.01 μ F	10%	50V	R399	1-216-689-11	RES-CHIP	39K	5%	1/10W
C347	1-163-021-91	CERAMIC CHIP	0.01 μ F	10%	50V	R434	1-216-065-91	RES-CHIP	4.7K	5%	1/10W
C389	1-104-760-11	CERAMIC CHIP	0.047 μ F	10%	50V	R435	1-216-065-91	RES-CHIP	4.7K	5%	1/10W
C451	1-163-038-91	CERAMIC CHIP	0.1 μ F		25V	TUNER					
C452	1-163-038-91	CERAMIC CHIP	0.1 μ F		25V	\triangle TU150	8-598-501-30	TUNER, FSS BTF-FA402			
C453	1-163-038-91	CERAMIC CHIP	0.1 μ F		25V						
C454	1-163-038-91	CERAMIC CHIP	0.1 μ F		25V						
CONNECTOR											
* CN304	1-564-507-11	PLUG,CONNECTOR 4P									
* CN305	1-573-298-21	CONNECTOR, BOARD TO BOARD 20P									
* CN401	1-564-505-11	PLUG,CONNECTOR 2P									
DIODE											
D303	8-719-991-33	DIODE 1SS133T-77									
COIL											
L150	1-412-058-11	INDUCTOR	10 μ H								
L151	1-412-064-11	INDUCTOR	100 μ H								
TRANSISTOR											
Q151	8-729-424-02	TRANSISTOR 2SB709A-QRS-TX									
Q152	8-729-422-27	TRANSISTOR 2SD601A-QRS-TX									
Q378	8-729-424-02	TRANSISTOR 2SB709A-QRS-TX									
Q379	8-729-424-02	TRANSISTOR 2SB709A-QRS-TX									
Q380	8-729-424-02	TRANSISTOR 2SB709A-QRS-TX									
RESISTOR											
R048	1-216-025-11	RES-CHIP	100	5%	1/10W						
R069	1-249-409-11	CARBON	220	5%	1/4W						
R100	1-216-295-91	SHORT									
R101	1-216-295-91	SHORT									
R150	1-216-053-00	RES-CHIP	1.5K	5%	1/10W						
R151	1-216-025-11	RES-CHIP	100	5%	1/10W						
R154	1-216-043-91	RES-CHIP	560	5%	1/10W						
R155	1-216-043-91	RES-CHIP	560	5%	1/10W						
R156	1-216-085-91	RES-CHIP	33K	5%	1/10W						



COMPLETE PARTS LISTING FV SERIES

REF. NO.	PART NO.	DESCRIPTION	VALUES			REF. NO.	PART NO.	DESCRIPTION	VALUES		
					A-1304-202-A MA (VAR) MOUNTED PC BOARD (KV-27FV17/29FV17/29FV17C ONLY)						
					CAPACITOR						
C003	1-126-959-11	ELECT	0.47μF	20%	50V	C097	1-163-009-91	CERAMIC CHIP	0.001μF	10%	50V
C005	1-164-005-11	CERAMIC CHIP	0.47μF		25V	C099	1-126-960-11	ELECT	1μF	20%	50V
C006	1-126-964-11	ELECT	10μF	20%	50V	C151	1-126-960-11	ELECT	1μF	20%	50V
C009	1-163-259-91	CERAMIC CHIP	220pF	5%	50V	C153	1-163-017-00	CERAMIC CHIP	0.0047μF	10%	50V
C010	1-163-035-00	CERAMIC CHIP	0.047μF		50V	C154	1-126-967-11	ELECT	47μF	20%	50V
C011	1-163-259-91	CERAMIC CHIP	220pF	5%	50V	C155	1-126-964-11	ELECT	10μF	20%	50V
C012	1-163-009-91	CERAMIC CHIP	0.001μF	10%	50V	C156	1-104-664-11	ELECT	47μF	20%	25V
C015	1-163-231-11	CERAMIC CHIP	15pF	5%	50V	C157	1-126-968-11	ELECT	100μF	20%	50V
C016	1-163-231-11	CERAMIC CHIP	15pF	5%	50V	C306	1-164-346-11	CERAMIC CHIP	1μF		16V
C017	1-126-960-11	ELECT	1μF	20%	50V	C312	1-164-005-11	CERAMIC CHIP	0.47μF		25V
C019	1-163-259-91	CERAMIC CHIP	220pF	5%	50V	C313	1-163-021-91	CERAMIC CHIP	0.01μF	10%	50V
C020	1-163-038-91	CERAMIC CHIP	0.1μF		25V	C315	1-104-664-11	ELECT	47μF	20%	25V
C021	1-163-259-91	CERAMIC CHIP	220pF	5%	50V	C316	1-163-243-11	CERAMIC CHIP	47pF	5%	50V
C022	1-163-135-00	CERAMIC CHIP	560pF	5%	50V	C318	1-163-021-91	CERAMIC CHIP	0.01μF	10%	50V
C027	1-163-009-91	CERAMIC CHIP	0.001μF	10%	50V	C319	1-126-767-11	ELECT	1000μF	20%	16V
C028	1-163-259-91	CERAMIC CHIP	220pF	5%	50V	C320	1-164-005-11	CERAMIC CHIP	0.47μF		25V
C032	1-164-004-11	CERAMIC CHIP	0.1μF	10%	25V	C321	1-164-005-11	CERAMIC CHIP	0.47μF		25V
C033	1-163-259-91	CERAMIC CHIP	220pF	5%	50V	C322	1-164-005-11	CERAMIC CHIP	0.47μF		25V
C034	1-163-037-11	CERAMIC CHIP	0.022μF	10%	50V	C323	1-164-004-11	CERAMIC CHIP	0.1μF	10%	25V
C037	1-164-161-11	CERAMIC CHIP	0.0022μF	10%	50V	C325	1-164-005-11	CERAMIC CHIP	0.47μF		25V
C038	1-126-935-11	ELECT	470μF	20%	16V	C326	1-164-004-11	CERAMIC CHIP	0.1μF	10%	25V
C039	1-126-964-11	ELECT	10μF	20%	50V	C328	1-164-004-11	CERAMIC CHIP	0.1μF	10%	25V
C040	1-163-229-11	CERAMIC CHIP	12pF	5%	50V	C329	1-164-004-11	CERAMIC CHIP	0.1μF	10%	25V
C041	1-163-237-11	CERAMIC CHIP	27pF	5%	50V	C330	1-126-960-11	ELECT	1μF	20%	50V
C042	1-163-259-91	CERAMIC CHIP	220pF	5%	50V	C331	1-163-021-91	CERAMIC CHIP	0.01μF	10%	50V
C043	1-163-009-91	CERAMIC CHIP	0.001μF	10%	50V	C334	1-163-003-11	CERAMIC CHIP	330pF	10%	50V
C044	1-163-009-91	CERAMIC CHIP	0.001μF	10%	50V	C335	1-126-963-11	ELECT	4.7μF	20%	50V
C045	1-164-161-11	CERAMIC CHIP	0.0022μF	10%	50V	C338	1-164-004-11	CERAMIC CHIP	0.1μF	10%	25V
C046	1-104-664-11	ELECT	47μF	20%	25V	C339	1-126-960-11	ELECT	1μF	20%	50V
C047	1-163-259-91	CERAMIC CHIP	220pF	5%	50V	C341	1-163-233-91	CERAMIC CHIP	18pF	5%	50V
C048	1-163-259-91	CERAMIC CHIP	220pF	5%	50V	C345	1-163-021-91	CERAMIC CHIP	0.01μF	10%	50V
C051	1-126-943-11	ELECT	2200μF	20%	25V	C346	1-163-021-91	CERAMIC CHIP	0.01μF	10%	50V
C060	1-163-005-91	CERAMIC CHIP	470pF	10%	50V	C347	1-163-021-91	CERAMIC CHIP	0.01μF	10%	50V
C062	1-126-959-11	ELECT	0.47μF	20%	50V	C348	1-164-005-11	CERAMIC CHIP	0.47μF		25V
C063	1-137-194-81	FILM	0.47μF	5%	50V	C352	1-163-021-91	CERAMIC CHIP	0.01μF	10%	50V
C064	1-163-017-00	CERAMIC CHIP	0.0047μF	10%	50V	C353	1-163-021-91	CERAMIC CHIP	0.01μF	10%	50V
C070	1-163-009-91	CERAMIC CHIP	0.001μF	10%	50V	C356	1-164-004-11	CERAMIC CHIP	0.1μF	10%	25V
C071	1-163-009-91	CERAMIC CHIP	0.001μF	10%	50V	C357	1-104-664-11	ELECT	47μF	20%	25V
C076	1-163-259-91	CERAMIC CHIP	220pF	5%	50V	C358	1-104-664-11	ELECT	47μF	20%	25V
C077	1-163-259-91	CERAMIC CHIP	220pF	5%	50V	C359	1-163-038-91	CERAMIC CHIP	0.1μF		25V
C091	1-115-185-11	CERAMIC CHIP	0.033μF	10%	50V	C360	1-126-959-11	ELECT	0.47μF	20%	50V
C093	1-163-259-91	CERAMIC CHIP	220pF	5%	50V	C361	1-163-038-91	CERAMIC CHIP	0.1μF		25V
						C362	1-104-664-11	ELECT	47μF	20%	25V
						C363	1-163-038-91	CERAMIC CHIP	0.1μF		25V
						C364	1-164-004-11	CERAMIC CHIP	0.1μF	10%	25V
						C365	1-137-194-81	FILM	0.47μF	5%	50V
						C367	1-163-005-91	CERAMIC CHIP	470pF	10%	50V
						C370	1-126-933-11	ELECT	100μF	20%	16V



NOTE: The components identified by shading and \triangle mark are critical for safety. Replace only with part number specified.

NOTE: Les composants identifiés par un trame et une marque \triangle sont critiques pour la sécurité. Ne les remplacer que par une pièce portant le numéro spécifique.

COMPLETE PARTS LISTING FV SERIES

REF. NO.	PART NO.	DESCRIPTION	VALUES			REF. NO.	PART NO.	DESCRIPTION	VALUES		
C371	1-163-243-11	CERAMIC CHIP	47pF	5%	50V	JR003	1-216-295-91	SHORT			
C377	1-126-963-11	ELECT	4.7 μ F	20%	50V	JR005	1-216-295-91	SHORT			
C389	1-115-185-11	CERAMIC CHIP	0.033 μ F	10%	50V	JR006	1-216-295-91	SHORT			
C395	1-163-021-91	CERAMIC CHIP	0.01 μ F	10%	50V	JR007	1-216-295-91	SHORT			
C396	1-164-004-11	CERAMIC CHIP	0.1 μ F	10%	25V	JR008	1-216-295-91	SHORT			
C398	1-126-964-11	ELECT	10 μ F	20%	50V	JR010	1-216-295-91	SHORT			
C451	1-163-038-91	CERAMIC CHIP	0.1 μ F		25V	JR011	1-216-295-91	SHORT			
C452	1-163-038-91	CERAMIC CHIP	0.1 μ F		25V	JR090	1-216-295-91	SHORT			
C453	1-163-038-91	CERAMIC CHIP	0.1 μ F		25V	JR100	1-216-295-91	SHORT			
C454	1-163-038-91	CERAMIC CHIP	0.1 μ F		25V	JR101	1-216-295-91	SHORT			
CONNECTOR						JR296	1-216-295-91	SHORT			
CN001	1-764-334-11	PLUG,CONNECTOR 11P				JR297	1-216-295-91	SHORT			
* CN002	1-560-124-00	PLUG,CONNECTOR (2.5MM) 4P				JR298	1-216-295-91	SHORT			
* CN003	1-564-512-11	PLUG,CONNECTOR 9P				JR299	1-216-295-91	SHORT			
* CN004	1-564-512-11	PLUG,CONNECTOR 9P				JR300	1-216-295-91	SHORT			
* CN005	1-764-333-11	PLUG,CONNECTOR 10P				JR310	1-216-295-91	SHORT			
* CN006	1-764-333-11	PLUG,CONNECTOR 10P				JR311	1-216-295-91	SHORT			
* CN302	1-564-507-11	PLUG,CONNECTOR 4P				JR355	1-216-295-91	SHORT			
* CN304	1-564-507-11	PLUG,CONNECTOR 4P				JR359	1-216-295-91	SHORT			
CN305	1-573-298-21	CONNECTOR, BOARD TO BOARD 20P				JR378	1-216-295-91	SHORT			
* CN306	1-691-616-21	CONNECTOR, BOARD TO BOARD 15P				JR379	1-216-295-91	SHORT			
* CN309	1-564-506-11	PLUG,CONNECTOR 3P				JR399	1-216-295-91	SHORT			
CN401	1-564-505-11	PLUG,CONNECTOR 2P				JR402	1-216-295-91	SHORT			
DIODE						JR501	1-216-295-91	SHORT			
\triangle D001	8-719-069-54	DIODE UDZSTE-175.1B				JR502	1-216-295-91	SHORT			
D002	8-719-110-17	DIODE MTZJ-T-77-10B				COIL					
D003	8-719-404-50	DIODE MA111-TX				L002	1-412-064-11	INDUCTOR	100 μ H		
D004	8-719-069-54	DIODE UDZSTE-175.1B				L003	1-412-064-11	INDUCTOR	100 μ H		
D005	8-719-109-89	DIODE MTZJ-T-77-5.6C				L040	1-408-963-11	INDUCTOR	2.7 μ H		
D006	8-719-069-60	DIODE UDZSTE-179.1B				L150	1-412-058-11	INDUCTOR	10 μ H		
D075	8-719-404-50	DIODE MA111-TX				L151	1-412-064-11	INDUCTOR	100 μ H		
D301	8-719-921-44	DIODE MTZJ-T-77-5.1C				L301	1-412-029-11	INDUCTOR	10 μ H		
D303	8-719-991-33	DIODE 1SS133T-77				L302	1-412-031-11	INDUCTOR	47 μ H		
D304	8-719-981-99	DIODE MTZJ-T-77-3.3				L305	1-412-029-11	INDUCTOR	10 μ H		
D305	8-719-921-44	DIODE MTZJ-T-77-5.1C				L308	1-412-064-11	INDUCTOR	100 μ H		
D360	8-719-914-44	DIODE DAP202K-T-146				L310	1-412-064-11	INDUCTOR	100 μ H		
FERRITE BEAD						TRANSISTOR					
FB001	1-414-234-22	FERRITE	0 μ H			Q001	8-729-424-02	TRANSISTOR 2SB709A-QRS-TX			
FB002	1-414-234-22	FERRITE	0 μ H			Q002	8-729-422-27	TRANSISTOR 2SD601A-QRS-TX			
IC						Q003	8-729-422-27	TRANSISTOR 2SD601A-QRS-TX			
IC001	8-759-827-83	IC M37280MK-114SP				Q004	8-729-424-02	TRANSISTOR 2SB709A-QRS-TX			
IC002	8-759-663-29	IC MM1476AF(TP)				Q006	8-729-424-02	TRANSISTOR 2SB709A-QRS-TX			
IC003	8-759-699-33	IC M24C16-MN6T(A)				Q082	8-729-422-27	TRANSISTOR 2SD601A-QRS-TX			
\triangle IC301	8-752-100-49	IC CXA2154AS				Q151	8-729-424-02	TRANSISTOR 2SB709A-QRS-TX			
CHIP CONDUCTOR						Q152	8-729-422-27	TRANSISTOR 2SD601A-QRS-TX			
JR001	1-216-295-91	SHORT				Q301	8-729-422-27	TRANSISTOR 2SD601A-QRS-TX			
JR002	1-216-295-91	SHORT				Q303	8-729-424-02	TRANSISTOR 2SB709A-QRS-TX			
						Q304	8-729-422-27	TRANSISTOR 2SD601A-QRS-TX			



COMPLETE PARTS LISTING FV SERIES

REF. NO.	PART NO.	DESCRIPTION	VALUES			REF. NO.	PART NO.	DESCRIPTION	VALUES		
Q305	8-729-424-02	TRANSISTOR 2SB709A-QRS-TX				R035	1-216-033-00	RES-CHIP	220	5%	1/10W
Q306	8-729-424-02	TRANSISTOR 2SB709A-QRS-TX				R036	1-216-049-11	RES-CHIP	1K	5%	1/10W
Q356	8-729-422-27	TRANSISTOR 2SD601A-QRS-TX				R037	1-249-409-11	CARBON	220	5%	1/4W
Q357	8-729-424-02	TRANSISTOR 2SB709A-QRS-TX				R038	1-216-049-11	RES-CHIP	1K	5%	1/10W
Q365	8-729-422-27	TRANSISTOR 2SD601A-QRS-TX				R039	1-216-045-00	RES-CHIP	680	5%	1/10W
Q368	8-729-422-27	TRANSISTOR 2SD601A-QRS-TX				R040	1-249-409-11	CARBON	220	5%	1/4W
Q375	8-729-422-27	TRANSISTOR 2SD601A-QRS-TX				R041	1-216-045-00	RES-CHIP	680	5%	1/10W
Q378	8-729-424-02	TRANSISTOR 2SB709A-QRS-TX				R042	1-216-071-00	RES-CHIP	8.2K	5%	1/10W
Q379	8-729-424-02	TRANSISTOR 2SB709A-QRS-TX				R043	1-249-417-11	CARBON	1K	5%	1/4W
Q380	8-729-424-02	TRANSISTOR 2SB709A-QRS-TX				R044	1-216-033-00	RES-CHIP	220	5%	1/10W
Q387	8-729-424-02	TRANSISTOR 2SB709A-QRS-TX				R045	1-216-065-91	RES-CHIP	4.7K	5%	1/10W
Q388	8-729-424-02	TRANSISTOR 2SB709A-QRS-TX				R046	1-216-033-00	RES-CHIP	220	5%	1/10W
Q389	8-729-424-02	TRANSISTOR 2SB709A-QRS-TX				R047	1-216-065-91	RES-CHIP	4.7K	5%	1/10W
		RESISTOR				R048	1-216-025-11	RES-CHIP	100	5%	1/10W
R001	1-216-043-91	RES-CHIP	560	5%	1/10W	R050	1-216-033-00	RES-CHIP	220	5%	1/10W
R002	1-216-041-00	RES-CHIP	470	5%	1/10W	R051	1-216-033-00	RES-CHIP	220	5%	1/10W
R003	1-247-807-31	CARBON	100	5%	1/4W	R052	1-249-417-11	CARBON	1K	5%	1/4W
R004	1-216-061-91	RES-CHIP	3.3K	5%	1/10W	R054	1-216-065-91	RES-CHIP	4.7K	5%	1/10W
R005	1-216-295-91	SHORT				R055	1-216-065-91	RES-CHIP	4.7K	5%	1/10W
R006	1-216-025-11	RES-CHIP	100	5%	1/10W	R056	1-208-798-11	METAL CHIP	4.7K	0.50%	1/10W
R007	1-216-025-11	RES-CHIP	100	5%	1/10W	R057	1-216-097-11	RES-CHIP	100K	5%	1/10W
R008	1-216-049-11	RES-CHIP	1K	5%	1/10W	R058	1-216-097-11	RES-CHIP	100K	5%	1/10W
R009	1-216-121-11	RES-CHIP	1M	5%	1/10W	R060	1-249-409-11	CARBON	220	5%	1/4W
R010	1-216-033-00	RES-CHIP	220	5%	1/10W	R061	1-216-033-00	RES-CHIP	220	5%	1/10W
R011	1-216-033-00	RES-CHIP	220	5%	1/10W	R064	1-216-295-91	SHORT			
R012	1-216-045-00	RES-CHIP	680	5%	1/10W	R069	1-249-409-11	CARBON	220	5%	1/4W
R013	1-249-417-11	CARBON	1K	5%	1/4W	R070	1-216-065-91	RES-CHIP	4.7K	5%	1/10W
R014	1-216-073-91	RES-CHIP	10K	5%	1/10W	R071	1-216-065-91	RES-CHIP	4.7K	5%	1/10W
R015	1-216-073-91	RES-CHIP	10K	5%	1/10W	R073	1-249-425-11	CARBON	4.7K	5%	1/4W
R016	1-216-041-00	RES-CHIP	470	5%	1/10W	R074	1-216-065-91	RES-CHIP	4.7K	5%	1/10W
R017	1-208-798-11	METAL CHIP	4.7K	0.50%	1/10W	R077	1-216-097-11	RES-CHIP	100K	5%	1/10W
R018	1-249-409-11	CARBON	220	5%	1/4W	R085	1-216-065-91	RES-CHIP	4.7K	5%	1/10W
R019	1-216-113-00	RES-CHIP	470K	5%	1/10W	R086	1-216-045-00	RES-CHIP	680	5%	1/10W
R020	1-216-033-00	RES-CHIP	220	5%	1/10W	R087	1-216-045-00	RES-CHIP	680	5%	1/10W
R021	1-216-073-91	RES-CHIP	10K	5%	1/10W	R088	1-216-045-00	RES-CHIP	680	5%	1/10W
R022	1-249-409-11	CARBON	220	5%	1/4W	R089	1-216-033-00	RES-CHIP	220	5%	1/10W
R023	1-249-429-11	CARBON	10K	5%	1/4W	R091	1-216-073-91	RES-CHIP	10K	5%	1/10W
R024	1-249-409-11	CARBON	220	5%	1/4W	R092	1-208-798-11	METAL CHIP	4.7K	0.50%	1/10W
R025	1-249-426-11	CARBON	5.6K	5%	1/4W	R093	1-216-065-91	RES-CHIP	4.7K	5%	1/10W
R026	1-249-426-11	CARBON	5.6K	5%	1/4W	R094	1-216-065-91	RES-CHIP	4.7K	5%	1/10W
R027	1-249-426-11	CARBON	5.6K	5%	1/4W	R095	1-216-065-91	RES-CHIP	4.7K	5%	1/10W
R028	1-216-049-11	RES-CHIP	1K	5%	1/10W	R096	1-216-065-91	RES-CHIP	4.7K	5%	1/10W
R029	1-216-065-91	RES-CHIP	4.7K	5%	1/10W	R097	1-249-414-11	CARBON	560	5%	1/4W
R030	1-216-065-91	RES-CHIP	4.7K	5%	1/10W	R099	1-216-089-91	RES-CHIP	47K	5%	1/10W
R031	1-216-355-11	METAL OXIDE	3.3	5%	1W	R100	1-216-295-91	SHORT			
R032	1-216-033-00	RES-CHIP	220	5%	1/10W	R101	1-216-295-91	SHORT			
R033	1-216-033-00	RES-CHIP	220	5%	1/10W	R150	1-216-053-00	RES-CHIP	1.5K	5%	1/10W
R034	1-216-033-00	RES-CHIP	220	5%	1/10W	R151	1-216-025-11	RES-CHIP	100	5%	1/10W



COMPLETE PARTS LISTING FV SERIES

REF. NO.	PART NO.	DESCRIPTION	VALUES			REF. NO.	PART NO.	DESCRIPTION	VALUES		
R154	1-216-043-91	RES-CHIP	560	5%	1/10W	R303	1-216-073-91	RES-CHIP	10K	5%	1/10W
R155	1-216-043-91	RES-CHIP	560	5%	1/10W	R304	1-247-807-31	CARBON	100	5%	1/4W
R156	1-216-085-91	RES-CHIP	33K	5%	1/10W	R306	1-216-025-11	RES-CHIP	100	5%	1/10W
R157	1-216-081-00	RES-CHIP	22K	5%	1/10W	R308	1-216-022-00	RES-CHIP	75	5%	1/10W
R158	1-216-025-11	RES-CHIP	100	5%	1/10W	R310	1-249-417-11	CARBON	1K	5%	1/4W
R159	1-216-025-11	RES-CHIP	100	5%	1/10W	R312	1-249-417-11	CARBON	1K	5%	1/4W
R199	1-216-295-91	SHORT				R313	1-216-049-11	RES-CHIP	1K	5%	1/10W
R251	1-216-065-91	RES-CHIP	4.7K	5%	1/10W	R314	1-216-081-00	RES-CHIP	22K	5%	1/10W
R253	1-216-049-11	RES-CHIP	1K	5%	1/10W	R322	1-216-025-11	RES-CHIP	100	5%	1/10W
R256	1-216-073-91	RES-CHIP	10K	5%	1/10W	R323	1-216-025-11	RES-CHIP	100	5%	1/10W
R257	1-216-049-11	RES-CHIP	1K	5%	1/10W	R324	1-216-065-91	RES-CHIP	4.7K	5%	1/10W
R258	1-216-065-91	RES-CHIP	4.7K	5%	1/10W	R326	1-208-806-11	METAL CHIP	10K	0.50%	1/10W
R259	1-249-429-11	CARBON	10K	5%	1/4W	R327	1-216-025-11	RES-CHIP	100	5%	1/10W
R260	1-249-409-11	CARBON	220	5%	1/4W	R329	1-216-025-11	RES-CHIP	100	5%	1/10W
R261	1-216-113-00	RES-CHIP	470K	5%	1/10W	R332	1-216-022-00	RES-CHIP	75	5%	1/10W
R262	1-247-807-31	CARBON	100	5%	1/4W	R335	1-216-057-00	RES-CHIP	2.2K	5%	1/10W
R263	1-216-025-11	RES-CHIP	100	5%	1/10W	R336	1-216-057-00	RES-CHIP	2.2K	5%	1/10W
R264	1-216-081-00	RES-CHIP	22K	5%	1/10W	R337	1-216-057-00	RES-CHIP	2.2K	5%	1/10W
R266	1-216-081-00	RES-CHIP	22K	5%	1/10W	R338	1-216-073-91	RES-CHIP	10K	5%	1/10W
R267	1-216-049-11	RES-CHIP	1K	5%	1/10W	R340	1-216-025-11	RES-CHIP	100	5%	1/10W
R268	1-216-045-00	RES-CHIP	680	5%	1/10W	R341	1-216-089-91	RES-CHIP	47K	5%	1/10W
R269	1-216-049-11	RES-CHIP	1K	5%	1/10W	R342	1-216-049-11	RES-CHIP	1K	5%	1/10W
R270	1-216-081-00	RES-CHIP	22K	5%	1/10W	R343	1-216-097-11	RES-CHIP	100K	5%	1/10W
R271	1-216-081-00	RES-CHIP	22K	5%	1/10W	R344	1-216-295-91	SHORT			
R272	1-216-081-00	RES-CHIP	22K	5%	1/10W	R345	1-216-097-11	RES-CHIP	100K	5%	1/10W
R273	1-216-073-91	RES-CHIP	10K	5%	1/10W	R346	1-216-097-11	RES-CHIP	100K	5%	1/10W
R274	1-216-295-91	SHORT				R347	1-216-025-11	RES-CHIP	100	5%	1/10W
R276	1-216-085-91	RES-CHIP	33K	5%	1/10W	R348	1-216-022-00	RES-CHIP	75	5%	1/10W
R277	1-216-129-00	RES-CHIP	2.2M	5%	1/10W	R349	1-216-025-11	RES-CHIP	100	5%	1/10W
R278	1-216-295-91	SHORT				R350	1-216-022-00	RES-CHIP	75	5%	1/10W
R279	1-247-807-31	CARBON	100	5%	1/4W	R356	1-216-025-11	RES-CHIP	100	5%	1/10W
R280	1-216-069-00	RES-CHIP	6.8K	5%	1/10W	R357	1-216-022-00	RES-CHIP	75	5%	1/10W
R281	1-208-798-11	METAL CHIP	4.7K	0.50%	1/10W	R358	1-216-093-91	RES-CHIP	68K	5%	1/10W
R282	1-208-790-11	METAL CHIP	2.2K	0.50%	1/10W	R360	1-216-093-91	RES-CHIP	68K	5%	1/10W
R283	1-216-689-11	RES-CHIP	39K	5%	1/10W	R361	1-216-022-00	RES-CHIP	75	5%	1/10W
R284	1-216-049-11	RES-CHIP	1K	5%	1/10W	R370	1-249-429-11	CARBON	10K	5%	1/4W
R285	1-216-049-11	RES-CHIP	1K	5%	1/10W	R376	1-216-022-00	RES-CHIP	75	5%	1/10W
R286	1-216-089-91	RES-CHIP	47K	5%	1/10W	R380	1-216-295-91	SHORT			
R287	1-216-097-11	RES-CHIP	100K	5%	1/10W	R381	1-216-069-00	RES-CHIP	6.8K	5%	1/10W
R288	1-216-041-00	RES-CHIP	470	5%	1/10W	R382	1-216-295-91	SHORT			
R289	1-216-041-00	RES-CHIP	470	5%	1/10W	R383	1-216-295-91	SHORT			
R290	1-216-043-91	RES-CHIP	560	5%	1/10W	R384	1-216-295-91	SHORT			
R291	1-216-025-11	RES-CHIP	100	5%	1/10W	R387	1-216-025-11	RES-CHIP	100	5%	1/10W
R296	1-216-057-00	RES-CHIP	2.2K	5%	1/10W	R388	1-216-025-11	RES-CHIP	100	5%	1/10W
R297	1-216-025-11	RES-CHIP	100	5%	1/10W	R398	1-216-091-00	RES-CHIP	56K	5%	1/10W
R298	1-216-065-91	RES-CHIP	4.7K	5%	1/10W	R399	1-216-109-00	RES-CHIP	330K	5%	1/10W
R299	1-216-033-00	RES-CHIP	220	5%	1/10W	R434	1-216-065-91	RES-CHIP	4.7K	5%	1/10W
R301	1-216-022-00	RES-CHIP	75	5%	1/10W	R435	1-216-065-91	RES-CHIP	4.7K	5%	1/10W

NOTE: The components identified by shading and \triangle mark are critical for safety. Replace only with part number specified.

NOTE: Les composants identifiés par un trame et une marque \triangle sont critiques pour la sécurité. Ne les remplacer que par une pièce portant le numéro spécifique.

MA BC

COMPLETE PARTS LISTING FV SERIES

REF. NO.	PART NO.	DESCRIPTION	VALUES			REF. NO.	PART NO.	DESCRIPTION	VALUES		
TUNER											
\triangle	TU150	8-598-501-30	TUNER, FSS BTF-FA402			C3539	1-163-231-11	CERAMIC CHIP	15pF	5%	50V
CRYSTAL											
X001	1-767-487-11	VIBRATOR, CRYSTAL			C3541	1-163-106-00	CERAMIC CHIP	36pF	5%	50V	
X301	1-567-505-11	OSCILLATOR, CRYSTAL			C3542	1-126-964-11	ELECT	10 μ F	20%	50V	
BC											
*	A-1131-593-A	BC BOARD, MOUNTED (KV-27FV17/29FV17/29FV17C ONLY)			C3543	1-164-505-11	CERAMIC CHIP	2.2 μ F		16V	
CAPACITOR											
C3500	1-165-319-11	CERAMIC CHIP	0.1 μ F		50V	C3546	1-163-231-11	CERAMIC CHIP	15pF	5%	50V
C3501	1-163-231-11	CERAMIC CHIP	15pF	5%	50V	C3547	1-126-934-11	ELECT	220 μ F	20%	10V
C3502	1-165-319-11	CERAMIC CHIP	0.1 μ F		50V	C3548	1-164-004-11	CERAMIC CHIP	0.1 μ F	10%	25V
C3504	1-163-102-00	CERAMIC CHIP	24pF	5%	50V	C3549	1-104-660-91	ELECT	47 μ F	20%	16V
C3505	1-163-102-00	CERAMIC CHIP	24pF	5%	50V	C3550	1-163-031-91	CERAMIC CHIP	0.01 μ F		50V
C3506	1-165-319-11	CERAMIC CHIP	0.1 μ F		50V	C3551	1-104-660-91	ELECT	47 μ F	20%	16V
C3507	1-165-319-11	CERAMIC CHIP	0.1 μ F		50V	C3552	1-163-031-91	CERAMIC CHIP	0.01 μ F		50V
C3509	1-163-038-91	CERAMIC CHIP	0.1 μ F		25V	C3553	1-163-031-91	CERAMIC CHIP	0.01 μ F		50V
C3510	1-163-131-00	CERAMIC CHIP	390pF	5%	50V	C3554	1-104-660-91	ELECT	47 μ F	20%	16V
C3511	1-163-038-91	CERAMIC CHIP	0.1 μ F		25V	C3555	1-126-934-11	ELECT	220 μ F	20%	10V
C3512	1-165-319-11	CERAMIC CHIP	0.1 μ F		50V	C3556	1-164-004-11	CERAMIC CHIP	0.1 μ F	10%	25V
C3513	1-216-295-91	SHORT				C3557	1-163-031-91	CERAMIC CHIP	0.01 μ F		50V
C3514	1-163-031-91	CERAMIC CHIP	0.01 μ F		50V	C3558	1-104-660-91	ELECT	47 μ F	20%	16V
C3515	1-165-319-11	CERAMIC CHIP	0.1 μ F		50V	C3559	1-163-031-91	CERAMIC CHIP	0.01 μ F		50V
C3516	1-165-319-11	CERAMIC CHIP	0.1 μ F		50V	C3560	1-104-660-91	ELECT	47 μ F	20%	16V
C3517	1-126-924-11	ELECT	330 μ F	20%	6.3V	C3561	1-163-031-91	CERAMIC CHIP	0.01 μ F		50V
C3518	1-163-038-91	CERAMIC CHIP	0.1 μ F		25V	C3562	1-163-031-91	CERAMIC CHIP	0.01 μ F		50V
C3519	1-165-319-11	CERAMIC CHIP	0.1 μ F		50V	C3563	1-104-660-91	ELECT	47 μ F	20%	16V
C3520	1-165-319-11	CERAMIC CHIP	0.1 μ F		50V	C3564	1-104-660-91	ELECT	47 μ F	20%	16V
C3521	1-163-237-11	CERAMIC CHIP	27pF	5%	50V	C3565	1-163-031-91	CERAMIC CHIP	0.01 μ F		50V
C3522	1-104-660-91	ELECT	47 μ F	20%	16V	C3566	1-163-031-91	CERAMIC CHIP	0.01 μ F		50V
C3523	1-165-319-11	CERAMIC CHIP	0.1 μ F		50V	CONNECTOR					
C3524	1-165-319-11	CERAMIC CHIP	0.1 μ F		50V	*	CN3500	1-691-632-21	CONNECTOR, BOARD TO BOARD 15P		
C3525	1-163-038-91	CERAMIC CHIP	0.1 μ F		25V	FERRITE BEAD					
C3526	1-165-319-11	CERAMIC CHIP	0.1 μ F		50V	FB3500	1-414-234-22	FERRITE		0 μ H	
C3527	1-165-319-11	CERAMIC CHIP	0.1 μ F		50V	FB3501	1-414-234-22	FERRITE		0 μ H	
C3528	1-165-319-11	CERAMIC CHIP	0.1 μ F		50V	FB3502	1-414-234-22	FERRITE		0 μ H	
C3529	1-165-319-11	CERAMIC CHIP	0.1 μ F		50V	FB3503	1-414-234-22	FERRITE		0 μ H	
C3530	1-104-660-91	ELECT	47 μ F	20%	16V	FB3504	1-414-234-22	FERRITE		0 μ H	
C3531	1-165-319-11	CERAMIC CHIP	0.1 μ F		50V	FB3505	1-414-234-22	FERRITE		0 μ H	
C3532	1-126-964-11	ELECT	10 μ F	20%	50V	FB3506	1-414-234-22	FERRITE		0 μ H	
C3533	1-163-133-00	CERAMIC CHIP	470pF	5%	50V	FB3507	1-414-234-22	FERRITE		0 μ H	
C3534	1-126-960-11	ELECT	1 μ F	20%	50V	FB3508	1-414-234-22	FERRITE		0 μ H	
C3535	1-163-231-11	CERAMIC CHIP	15pF	5%	50V	FILTER					
C3536	1-126-960-11	ELECT	1 μ F	20%	50V	FL3500	1-239-848-21	FILTER, LOW PASS			
						FL3502	1-239-848-21	FILTER, LOW PASS			
						FL3503	1-239-848-21	FILTER, LOW PASS			
						FL3504	1-233-512-21	FERRITE		37 μ H	
						FL3505	1-233-512-21	FERRITE		37 μ H	
						FL3506	1-233-512-21	FERRITE		37 μ H	



COMPLETE PARTS LISTING

REF. NO.	PART NO.	DESCRIPTION	VALUES	REF. NO.	PART NO.	DESCRIPTION	VALUES
	IC			R3523	1-216-049-11	RES-CHIP	1K 5% 1/10W
IC3500	8-759-568-27	IC UPD424210LE-60-E2		R3524	1-216-089-91	RES-CHIP	47K 5% 1/10W
IC3501	8-759-594-44	IC UPD64082GF-3BA		R3525	1-216-057-00	RES-CHIP	2.2K 5% 1/10W
IC3502	8-759-583-47	IC UPC2933T-E1		R3526	1-216-105-91	RES-CHIP	220K 5% 1/10W
	COIL			R3527	1-216-033-00	RES-CHIP	220 5% 1/10W
L3500	1-412-028-11	INDUCTOR	4.7μH	R3528	1-208-776-11	METAL CHIP	560 0.50% 1/10W
L3501	1-412-058-11	INDUCTOR	10μH	R3529	1-208-772-11	METAL CHIP	390 0.50% 1/10W
L3502	1-412-058-11	INDUCTOR	10μH	R3530	1-216-067-00	RES-CHIP	5.6K 5% 1/10W
L3503	1-412-058-11	INDUCTOR	10μH	R3531	1-216-049-11	RES-CHIP	1K 5% 1/10W
L3504	1-412-058-11	INDUCTOR	10μH	R3532	1-216-025-11	RES-CHIP	100 5% 1/10W
L3505	1-412-058-11	INDUCTOR	10μH	R3534	1-216-049-11	RES-CHIP	1K 5% 1/10W
	TRANSISTOR			R3535	1-216-025-11	RES-CHIP	100 5% 1/10W
Q3500	8-729-424-02	TRANSISTOR 2SB709A-QRS-TX		R3544	1-216-049-11	RES-CHIP	1K 5% 1/10W
Q3501	8-729-422-27	TRANSISTOR 2SD601A-QRS-TX		R3545	1-216-043-91	RES-CHIP	560 5% 1/10W
Q3502	8-729-424-02	TRANSISTOR 2SB709A-QRS-TX		R3547	1-216-067-00	RES-CHIP	5.6K 5% 1/10W
Q3503	8-729-422-27	TRANSISTOR 2SD601A-QRS-TX		R3548	1-216-295-91	SHORT	
Q3504	8-729-424-02	TRANSISTOR 2SB709A-QRS-TX		R3549	1-216-057-00	RES-CHIP	2.2K 5% 1/10W
Q3505	8-729-422-27	TRANSISTOR 2SD601A-QRS-TX		R3550	1-208-780-11	METAL CHIP	820 0.50% 1/10W
Q3506	8-729-422-27	TRANSISTOR 2SD601A-QRS-TX		R3551	1-208-776-11	METAL CHIP	560 0.50% 1/10W
Q3510	8-729-424-02	TRANSISTOR 2SB709A-QRS-TX		R3552	1-208-764-11	METAL CHIP	180 0.50% 1/10W
Q3511	8-729-422-27	TRANSISTOR 2SD601A-QRS-TX		R3553	1-216-057-00	RES-CHIP	2.2K 5% 1/10W
Q3512	8-729-422-27	TRANSISTOR 2SD601A-QRS-TX		R3554	1-216-047-91	RES-CHIP	820 5% 1/10W
Q3513	8-729-422-27	TRANSISTOR 2SD601A-QRS-TX		R3555	1-216-075-00	RES-CHIP	12K 5% 1/10W
Q3514	8-729-424-02	TRANSISTOR 2SB709A-QRS-TX		R3556	1-216-085-91	RES-CHIP	33K 5% 1/10W
Q3515	8-729-422-27	TRANSISTOR 2SD601A-QRS-TX		R3557	1-216-049-11	RES-CHIP	1K 5% 1/10W
Q3516	8-729-422-27	TRANSISTOR 2SD601A-QRS-TX		R3558	1-216-017-91	RES-CHIP	47 5% 1/10W
Q3517	8-729-422-27	TRANSISTOR 2SD601A-QRS-TX		R3559	1-216-295-91	SHORT	
	RESISTOR			R3560	1-216-049-11	RES-CHIP	1K 5% 1/10W
R3503	1-216-017-91	RES-CHIP	47 5% 1/10W	R3561	1-216-043-91	RES-CHIP	560 5% 1/10W
R3504	1-216-295-91	SHORT		R3563	1-216-295-91	SHORT	
R3505	1-216-295-91	SHORT		R3564	1-216-295-91	SHORT	
R3506	1-216-295-91	SHORT		R3565	1-216-067-00	RES-CHIP	5.6K 5% 1/10W
R3507	1-216-295-91	SHORT		R3566	1-216-057-00	RES-CHIP	2.2K 5% 1/10W
R3508	1-216-295-91	SHORT		R3567	1-216-043-91	RES-CHIP	560 5% 1/10W
R3509	1-216-049-11	RES-CHIP	1K 5% 1/10W	R3568	1-216-047-91	RES-CHIP	820 5% 1/10W
R3510	1-216-041-00	RES-CHIP	470 5% 1/10W	R3569	1-216-057-00	RES-CHIP	2.2K 5% 1/10W
R3511	1-216-041-00	RES-CHIP	470 5% 1/10W	R3570	1-216-085-91	RES-CHIP	33K 5% 1/10W
R3512	1-216-295-91	SHORT		R3571	1-216-075-00	RES-CHIP	12K 5% 1/10W
R3514	1-216-025-11	RES-CHIP	100 5% 1/10W	R3572	1-216-049-11	RES-CHIP	1K 5% 1/10W
R3515	1-216-055-00	RES-CHIP	1.8K 5% 1/10W	R3573	1-216-017-91	RES-CHIP	47 5% 1/10W
R3516	1-216-055-00	RES-CHIP	1.8K 5% 1/10W	R3588	1-216-043-91	RES-CHIP	560 5% 1/10W
R3517	1-216-025-11	RES-CHIP	100 5% 1/10W		CRYSTAL		
R3518	1-216-025-11	RES-CHIP	100 5% 1/10W	X3500	1-767-606-11	VIBRATOR, CRYSTAL	
R3519	1-216-295-91	SHORT					
R3520	1-216-065-91	RES-CHIP	4.7K 5% 1/10W				
R3521	1-216-041-00	RES-CHIP	470 5% 1/10W				
R3522	1-216-041-00	RES-CHIP	470 5% 1/10W				

NOTE: The components identified by shading and \triangle mark are critical for safety. Replace only with part number specified.

NOTE: Les composants identifiés par un trame et une marque \triangle sont critiques pour la sécurité. Ne les remplacer que par une pièce portant le numéro spécifique.



COMPLETE PARTS LISTING

REF. NO.	PART NO.	DESCRIPTION	VALUES			REF. NO.	PART NO.	DESCRIPTION	VALUES			
R3336	1-216-041-00	RES-CHIP	470	5%	1/10W	DIODE						
R3343	1-216-049-11	RES-CHIP	1K	5%	1/10W	D701	8-719-901-83	DIODE 1SS83TD				
R3346	1-216-049-11	RES-CHIP	1K	5%	1/10W	D702	8-719-901-83	DIODE 1SS83TD				
R3347	1-216-073-91	RES-CHIP	10K	5%	1/10W	D703	8-719-901-83	DIODE 1SS83TD				
R3348	1-216-073-91	RES-CHIP	10K	5%	1/10W	D704	8-719-302-43	DIODE RGP10GPKG23				
R3350	1-216-295-91	SHORT				IC						
R3351	1-216-033-00	RES-CHIP	220	5%	1/10W	IC701	8-759-803-42	IC LA6500-FA				
R3354	1-216-133-91	RES-CHIP	3.3M	5%	1/10W	IC702	8-759-562-43	IC TDA6108JF/N1B				
R3359	1-216-295-91	SHORT				JACK						
R3360	1-216-295-91	SHORT				\triangle J701	1-451-470-21	SOCKET, CRT				
R3361	1-216-295-91	SHORT				COIL						
R3362	1-216-061-91	RES-CHIP	3.3K	5%	1/10W	L701	1-408-613-31	INDUCTOR	68 μ H			
R3363	1-216-085-91	RES-CHIP	33K	5%	1/10W	TRANSISTOR						
R3364	1-216-025-11	RES-CHIP	100	5%	1/10W	Q700	8-729-423-33	TRANSISTOR 2SC3311A-QRSTA				
R3365	1-216-025-11	RES-CHIP	100	5%	1/10W	Q701	8-729-423-33	TRANSISTOR 2SC3311A-QRSTA				
R3368	1-216-073-91	RES-CHIP	10K	5%	1/10W	RESISTOR						
R3369	1-216-037-00	RES-CHIP	330	5%	1/10W	R700	1-249-433-11	CARBON	22K	5%	1/4W	
R3372	1-216-295-91	SHORT				R701	1-249-429-11	CARBON	10K	5%	1/4W	
R3374	1-216-295-91	SHORT				R702	1-249-409-11	CARBON	220	5%	1/4W	
CRYSTAL						R703	1-247-807-31	CARBON	100	5%	1/4W	
X3301	1-781-377-11	VIBRATOR, CRYSTAL				R704	1-249-421-11	CARBON	2.2K	5%	1/4W	
CA						R705	1-249-429-11	CARBON	10K	5%	1/4W	
*	A-1332-063-A	CA (VAR) BOARD, MOUNTED (KV-27FS13/27FS17/27FV17/29FV17/29FV17C ONLY)				R706	1-249-381-11	CARBON	1	5%	1/4W	
*	A-1332-061-A	CA (VAR) BOARD, MOUNTED (KV-32FS13/32FS17/34FS13C/34FS17 ONLY)				R707	1-249-383-11	CARBON	1.5	5%	1/4W	
*	4-382-854-11	SCREW (M3X10), P, SW (+)				R708	1-247-807-31	CARBON	100	5%	1/4W	
CAPACITOR						R709	1-247-807-31	CARBON	100	5%	1/4W	
C701	1-104-664-11	ELECT	47 μ F	20%	25V	R710	1-247-807-31	CARBON	100	5%	1/4W	
C702	1-136-165-00	FILM	0.1 μ F	5%	50V	R711	1-260-328-11	CARBON	1K	5%	1/2W	
C703	1-104-664-11	ELECT	47 μ F	20%	25V	R712	1-260-328-11	CARBON	1K	5%	1/2W	
C704	1-107-651-11	ELECT	4.7 μ F	20%	250V	R713	1-260-328-11	CARBON	1K	5%	1/2W	
C705	1-107-652-11	ELECT	10 μ F	20%	250V	R714	1-260-087-11	CARBON	100	5%	1/2W	
C706	1-137-528-11	MYLAR	0.1 μ F	10%	250V	R715	1-260-132-11	CARBON	560K	5%	1/2W	
C707	1-162-114-00	CERAMIC	0.0047 μ F		2KV	R716	1-260-123-11	CARBON	100K	5%	1/2W	
C708	1-136-165-00	FILM	0.1 μ F	5%	50V	R717	1-216-373-11	METAL OXIDE (KV-27FS13/27FS17/27FV17/29FV17/29FV17C ONLY)	2.2	5%	2W	
C709	1-126-934-11	ELECT	220 μ F	20%	16V	R718	1-216-373-11	METAL OXIDE (KV-32FS13/32FS17/34FS13C/34FS17 ONLY)	2.2	5%	2W	
C710	1-126-964-11	ELECT	10 μ F	20%	50V	R719	1-215-888-00	METAL OXIDE	220	5%	2W	
CONNECTOR						R720	1-249-421-11	CARBON	2.2K	5%	1/4W	
*	CN701	1-564-506-11	PLUG,CONNECTOR 3P				R721	1-249-421-11	CARBON	2.2K	5%	1/4W
	CN702	1-695-915-11	TAB (CONTACT)				VARIABLE RESISTOR					
	CN704	1-785-879-11	CONNECTOR, ONE TOUCH				RV701	1-241-656-11	RES, ADJ, METAL FILM 110M			
*	CN706	1-564-509-11	PLUG,CONNECTOR 6P									



COMPLETE PARTS LISTING

REF. NO.	PART NO.	DESCRIPTION	VALUES	REF. NO.	PART NO.	DESCRIPTION	VALUES
				<u>TRANSISTOR</u>			
				Q807	8-729-931-45	TRANSISTOR IRF614	
				Q808	8-729-140-97	TRANSISTOR 2SB734-T-34	
*	A-1342-550-A	VA (VAR) BOARD, MOUNTED (KV-27FS13/27FS17/27FV17/29FV17/29FV17C ONLY)		Q901	8-729-017-06	TRANSISTOR 2SC4793	
*	A-1342-549-A	VA (VAR) BOARD, MOUNTED (KV-32FS13/32FS17/34FS13C/34FS17 ONLY)		Q902	8-729-017-05	TRANSISTOR 2SA1837	
				Q903	8-729-423-33	TRANSISTOR 2SC3311A-QRSTA	
	4-382-854-11	SCREW (M3X10), P, SW (+)		Q904	8-729-423-33	TRANSISTOR 2SC3311A-QRSTA	
				Q905	8-729-119-76	TRANSISTOR 2SA1309A-QRSTA	
				Q906	8-729-423-33	TRANSISTOR 2SC3311A-QRSTA	
				<u>RESISTOR</u>			
				R818	1-216-025-11	RES-CHIP	100 5% 1/10W
				R826	1-249-421-11	CARBON	2.2K 5% 1/4W
				R876	1-216-049-11	RES-CHIP	1K 5% 1/10W
				R901	1-249-401-11	CARBON	47 5% 1/4W
				R902	1-249-386-11	CARBON	2.7 5% 1/4W
				R903	1-249-414-11	CARBON	560 5% 1/4W
				R904	1-249-432-11	CARBON	18K 5% 1/4W
				R905	1-249-417-11	CARBON	1K 5% 1/4W
				R906	1-249-432-11	CARBON	18K 5% 1/4W
				R907	1-249-386-11	CARBON	2.7 5% 1/4W
				R908	1-249-414-11	CARBON	560 5% 1/4W
				R909	1-260-312-11	CARBON	47 5% 1/2W
				R910	1-216-476-11	METAL OXIDE	180 5% 3W
				R911	1-249-403-11	CARBON	68 5% 1/4W
				R912	1-249-409-11	CARBON	220 5% 1/4W
				R913	1-249-403-11	CARBON	68 5% 1/4W
				R914	1-249-410-11	CARBON	270 5% 1/4W
				R915	1-249-417-11	CARBON	1K 5% 1/4W
				R916	1-249-417-11	CARBON	1K 5% 1/4W
				R917	1-249-417-11	CARBON	1K 5% 1/4W
				R918	1-247-807-31	CARBON	100 5% 1/4W
				R919	1-247-807-31	CARBON	100 5% 1/4W
				R920	1-249-416-11	CARBON	820 5% 1/4W
				R921	1-249-429-11	CARBON	10K 5% 1/4W
				R922	1-249-397-11	CARBON	22 5% 1/4W
				R923	1-249-401-11	CARBON	47 5% 1/4W
				<u>CAPACITOR</u>			
				C801	1-126-960-11	ELECT	1μF 20% 50V
				C802	1-126-964-11	ELECT	10μF 20% 50V
				C803	1-136-191-11	MYLAR	0.22μF 5% 63V
				<u>CONNECTOR</u>			
*	CN901	1-564-508-11	PLUG,CONNECTOR 5P				
*	CN902	1-770-723-11	CONNECTOR, BOARD TO BOARD 8P				
*	CN904	1-564-507-11	PLUG,CONNECTOR 4P				
				<u>DIODE</u>			
	D804	8-719-302-43	DIODE RGP10GPKG23		A-1343-875-A	D (VAR) BOARD, MOUNTED (KV-27FS13/27FS17/27FV17/29FV17/29FV17C ONLY)	
	D805	8-719-991-33	DIODE 1SS133T-77		A-1343-874-A	D (VAR) BOARD, MOUNTED (KV-32FS13/32FS17/34FS13C/34FS17 ONLY)	
	D806	8-719-991-33	DIODE 1SS133T-77				
	D807	8-719-210-21	DIODE ERA82-004TP5				
	D901	8-719-110-88	DIODE MTZJ-T-77-39				
	D902	8-719-110-88	DIODE MTZJ-T-77-39				
	D903	8-719-991-33	DIODE 1SS133T-77				
				<u>COIL</u>			
	L801	1-406-989-21	INDUCTOR 10mH				
	L802	1-459-111-00	INDUCTOR 10mH				
	L901	1-412-528-11	INDUCTOR 18μH				



COMPLETE PARTS LISTING

REF. NO.	PART NO.	DESCRIPTION	VALUES			REF. NO.	PART NO.	DESCRIPTION	VALUES		
C804	1-136-191-11	MYLAR	0.22μF	5%	63V	TRANSISTOR					
C807	1-163-021-91	CERAMIC CHIP	0.01μF	10%	50V	Q801	8-729-422-27	TRANSISTOR 2SD601A-QRS-TX			
C808	1-163-021-91	CERAMIC CHIP	0.01μF	10%	50V	Q802	8-729-424-02	TRANSISTOR 2SB709A-QRS-TX			
C809	1-110-501-11	CERAMIC CHIP	0.33μF	10%	16V	Q803	8-729-424-02	TRANSISTOR 2SB709A-QRS-TX			
C810	1-130-495-00	MYLAR	0.1μF	5%	50V	Q804	8-729-424-02	TRANSISTOR 2SB709A-QRS-TX			
C812	1-163-021-91	CERAMIC CHIP	0.01μF	10%	50V	Q805	8-729-140-97	TRANSISTOR 2SB734-T-34			
C814	1-163-021-91	CERAMIC CHIP	0.01μF	10%	50V	Q806	8-729-422-27	TRANSISTOR 2SD601A-QRS-TX			
C815	1-129-718-00	FILM	0.022μF	5%	630V	Q809	8-729-422-27	TRANSISTOR 2SD601A-QRS-TX			
C816	1-102-244-00	CERAMIC	220pF	10%	500V	Q810	8-729-043-95	TRANSISTOR 2SC3840K			
C817	1-129-709-91	FILM	0.0039μF	5%	630V	Q811	8-729-119-76	TRANSISTOR 2SA1309A-QRSTA			
		(KV-27FS13/27FS17/27FV17/29FV17/29FV17C ONLY)				Q812	8-729-119-76	TRANSISTOR 2SA1309A-QRSTA			
C817	1-129-928-00	FILM	0.0027μF	10%	630V	RESISTOR					
		(KV-32FS13/32FS17/34FS13C/34FS17 ONLY)				R801	1-216-089-91	RES-CHIP	47K	5%	1/10W
C818	1-164-735-51	CERAMIC	0.0015μF	10%	500V	R802	1-216-073-91	RES-CHIP	10K	5%	1/10W
		(KV-27FS13/27FS17/27FV17/29FV17/29FV17C ONLY)				R803	1-216-081-00	RES-CHIP	22K	5%	1/10W
C818	1-164-625-11	CERAMIC	680pF	10%	500V	R804	1-216-073-91	RES-CHIP	10K	5%	1/10W
		(KV-32FS13/32FS17/34FS13C/34FS17 ONLY)				R805	1-216-065-91	RES-CHIP	4.7K	5%	1/10W
C820	1-109-954-11	ELECT	0.47μF	20%	160V	R806	1-216-081-00	RES-CHIP	22K	5%	1/10W
C821	1-163-021-91	CERAMIC CHIP	0.01μF	10%	50V	R807	1-216-061-91	RES-CHIP	3.3K	5%	1/10W
C823	1-130-967-00	FILM	0.0027μF	5%	50V	R808	1-216-073-91	RES-CHIP	10K	5%	1/10W
C824	1-104-760-11	CERAMIC CHIP	0.047μF	10%	50V	R809	1-216-081-00	RES-CHIP	22K	5%	1/10W
C825	1-137-150-11	MYLAR	0.01μF	5%	50V	R811	1-216-025-11	RES-CHIP	100	5%	1/10W
C826	1-163-251-11	CERAMIC CHIP	100pF	5%	50V	R812	1-216-061-91	RES-CHIP	3.3K	5%	1/10W
C862	1-126-964-11	ELECT	10μF	20%	50V	R813	1-216-041-00	RES-CHIP	470	5%	1/10W
		CONNECTOR				R814	1-215-862-11	METAL OXIDE	68	5%	1W
* CN800	1-564-510-11	PLUG,CONNECTOR 7P						(KV-32FS13/32FS17/34FS13C/34FS17 ONLY)			
* CN801	1-564-507-11	PLUG,CONNECTOR 4P				R815	1-215-862-11	METAL OXIDE	68	5%	1W
* CN802	1-508-784-21	PIN,CONNECTOR (5MM PITCH) 1P				R816	1-247-807-31	CARBON	100	5%	1/4W
		DIODE				R817	1-216-091-00	RES-CHIP	56K	5%	1/10W
D801	8-719-109-89	DIODE MTZJ-T-77-5.6C						(KV-27FS13/27FS17/27FV17/29FV17/29FV17C ONLY)			
D802	8-719-991-33	DIODE 1SS133T-77				R817	1-208-822-11	METAL CHIP	47K	0.50%	1/10W
D808	8-719-991-33	DIODE 1SS133T-77						(KV-32FS13/32FS17/34FS13C/34FS17 ONLY)			
D809	8-719-110-41	DIODE MTZJ-T-77-15B				R819	1-216-089-91	RES-CHIP	47K	5%	1/10W
D810	8-719-970-87	DIODE ERA38-06TP1				R820	1-216-683-11	METAL CHIP	22K	0.50%	1/10W
								(KV-27FS13/27FS17/27FV17/29FV17/29FV17C ONLY)			
D811	8-719-970-87	DIODE ERA38-06TP1				R820	1-208-818-11	METAL CHIP	33K	0.50%	1/10W
D812	8-719-300-33	DIODE ERB44-06TP1						(KV-32FS13/32FS17/34FS13C/34FS17 ONLY)			
D813	8-719-991-33	DIODE 1SS133T-77				R821	1-216-077-91	RES-CHIP	15K	5%	1/10W
D814	8-719-991-33	DIODE 1SS133T-77						(KV-27FS13/27FS17/27FV17/29FV17/29FV17C ONLY)			
		IC				R821	1-216-061-91	RES-CHIP	3.3K	5%	1/10W
IC801	8-759-700-42	IC NJM2904D						(KV-32FS13/32FS17/34FS13C/34FS17 ONLY)			
IC802	8-759-659-67	IC NJM2903D				R822	1-216-065-91	RES-CHIP	4.7K	5%	1/10W
IC803	8-759-659-67	IC NJM2903D				R823	1-216-065-91	RES-CHIP	4.7K	5%	1/10W
		CHIP CONDUCTOR				R824	1-208-830-11	METAL CHIP	100K	0.50%	1/10W
JR801	1-216-295-91	SHORT				R825	1-208-830-11	METAL CHIP	100K	0.50%	1/10W
		COIL				R827	1-216-065-91	RES-CHIP	4.7K	5%	1/10W
L803	1-406-677-11	INDUCTOR	10mH			R828	1-216-085-91	RES-CHIP	33K	5%	1/10W
						R829	1-208-846-11	METAL CHIP	470K	0.50%	1/10W
						R830	1-216-295-91	SHORT			



COMPLETE PARTS LISTING

REF. NO.	PART NO.	DESCRIPTION	VALUES			REF. NO.	PART NO.	DESCRIPTION	VALUES		
R831	1-216-049-11	RES-CHIP	1K	5%	1/10W	R890	1-216-097-11	RES-CHIP	100K	5%	1/10W
R832	1-216-067-00	RES-CHIP	5.6K	5%	1/10W			(KV-32FS13/32FS17/34FS13C/34FS17 ONLY)			
		(KV-27FS13/27FS17/27FV17/29FV17/29FV17C ONLY)				R860	1-208-806-11	METAL CHIP	10K	0.50%	1/10W
R832	1-216-061-91	RES-CHIP	3.3K	5%	1/10W	R862	1-216-057-00	RES-CHIP	2.2K	5%	1/10W
		(KV-32FS13/32FS17/34FS13C/34FS17 ONLY)				R863	1-216-057-00	RES-CHIP	2.2K	5%	1/10W
R833	1-216-687-11	METAL CHIP	33K	0.50%	1/10W	R864	1-216-033-00	RES-CHIP	220	5%	1/10W
		(KV-27FS13/27FS17/27FV17/29FV17/29FV17C ONLY)				R865	1-216-097-11	RES-CHIP	100K	5%	1/10W
R833	1-216-689-11	RES-CHIP	39K	5%	1/10W	R866	1-249-429-11	CARBON	10K	5%	1/4W
		(KV-32FS13/32FS17/34FS13C/34FS17 ONLY)				R867	1-216-073-91	RES-CHIP	10K	5%	1/10W
R834	1-216-065-91	RES-CHIP	4.7K	5%	1/10W	R868	1-216-073-91	RES-CHIP	10K	5%	1/10W
R835	1-216-057-00	RES-CHIP	2.2K	5%	1/10W	R869	1-216-097-11	RES-CHIP	100K	5%	1/10W
R836	1-216-057-00	RES-CHIP	2.2K	5%	1/10W						
R837	1-208-808-11	METAL CHIP	12K	0.50%	1/10W	R870	1-216-057-00	RES-CHIP	2.2K	5%	1/10W
						R871	1-215-489-00	METAL	680K	1%	1/4W
R838	1-247-807-31	CARBON	100	5%	1/4W	R872	1-216-121-11	RES-CHIP	1M	5%	1/10W
R839	1-216-025-11	RES-CHIP	100	5%	1/10W	R873	1-216-073-91	RES-CHIP	10K	5%	1/10W
R840	1-216-093-91	RES-CHIP	68K	5%	1/10W	R874	1-216-037-00	RES-CHIP	330	5%	1/10W
		(KV-27FS13/27FS17/27FV17/29FV17/29FV17C ONLY)				R875	1-216-035-00	RES-CHIP	270	5%	1/10W
R841	1-208-802-11	METAL CHIP	6.8K	0.50%	1/10W						
		(KV-27FS13/27FS17/27FV17/29FV17/29FV17C ONLY)				TRANSFORMER					
R841	1-208-806-11	METAL CHIP	10K	0.50%	1/10W	T801	1-424-584-11	TRANSFORMER, DYNAMIC FOCUS			
		(KV-32FS13/32FS17/34FS13C/34FS17 ONLY)									
R842	1-208-796-11	METAL CHIP	3.9K	0.50%	1/10W						
R845	1-249-441-11	CARBON	100K	5%	1/4W						
R846	1-249-441-11	CARBON	100K	5%	1/4W						
R847	1-249-441-11	CARBON	100K	5%	1/4W						
R848	1-215-876-00	METAL OXIDE	15K	5%	1W						
		(KV-27FS13/27FS17/27FV17/29FV17/29FV17C ONLY)									
R848	1-215-894-11	METAL OXIDE	2.2K	5%	2W						
		(KV-32FS13/32FS17/34FS13C/34FS17 ONLY)									
R849	1-215-920-11	METAL OXIDE	3.3K	5%	3W						
		(KV-27FS13/27FS17/27FV17/29FV17/29FV17C ONLY)									
R849	1-216-486-21	METAL OXIDE	8.2K	5%	3W						
		(KV-32FS13/32FS17/34FS13C/34FS17 ONLY)									
R850	1-216-486-21	METAL OXIDE	8.2K	5%	3W						
		(KV-32FS13/32FS17/34FS13C/34FS17 ONLY)									
R851	1-215-894-11	METAL OXIDE	2.2K	5%	2W						
		(KV-27FS13/27FS17/27FV17/29FV17/29FV17C ONLY)									
R851	1-215-922-11	METAL OXIDE	6.8K	5%	3W						
		(KV-32FS13/32FS17/34FS13C/34FS17 ONLY)									
R852	1-215-922-11	METAL OXIDE	6.8K	5%	3W						
		(KV-32FS13/32FS17/34FS13C/34FS17 ONLY)									
R854	1-216-069-00	RES-CHIP	6.8K	5%	1/10W						
		(KV-27FS13/27FS17/27FV17/29FV17/29FV17C ONLY)									
R854	1-216-067-00	RES-CHIP	5.6K	5%	1/10W						
		(KV-32FS13/32FS17/34FS13C/34FS17 ONLY)									
R855	1-216-089-91	RES-CHIP	47K	5%	1/10W						
		(KV-27FS13/27FS17/27FV17/29FV17/29FV17C ONLY)									
R855	1-216-091-00	RES-CHIP	56K	5%	1/10W						
		(KV-32FS13/32FS17/34FS13C/34FS17 ONLY)									
R857	1-208-818-11	METAL CHIP	33K	0.50%	1/10W						
		(KV-32FS13/32FS17/34FS13C/34FS17 ONLY)									



* **A-1372-817-A** HX BOARD, MOUNTED

CONNECTOR

* CN4001 1-564-518-11 PLUG,CONNECTOR 3P

RESISTOR

R4001 1-216-025-11 RES-CHIP 100 5% 1/10W
R4002 1-216-045-00 RES-CHIP 680 5% 1/10W
R4003 1-216-047-91 RES-CHIP 820 5% 1/10W
R4004 1-216-057-00 RES-CHIP 2.2K 5% 1/10W
R4005 1-216-069-00 RES-CHIP 6.8K 5% 1/10W

SWITCH

S4001 1-762-196-21 SWITCH TACTILE
S4002 1-762-196-21 SWITCH TACTILE
S4003 1-762-196-21 SWITCH TACTILE
S4004 1-762-196-21 SWITCH TACTILE
S4005 1-762-196-21 SWITCH TACTILE
S4006 1-762-196-21 SWITCH TACTILE



COMPLETE PARTS LISTING

REF. NO.	PART NO.	DESCRIPTION	VALUES			REF. NO.	PART NO.	DESCRIPTION	VALUES		
						HA					
*	A-1372-825-A	HA BOARD, MOUNTED (KV-27FV17/29FV17/29FV17C ONLY)									
						IC					
						IC4050	8-742-211-20	HYB IC SBX3071-71			
						CHIP CONDUCTOR					
						JR4051	1-216-295-91	SHORT			
						RESISTOR					
						R4050	1-249-401-11	CARBON	47	5%	1/4W
						R4051	1-216-049-11	RES-CHIP	1K	5%	1/10W
						K					
*	A-1380-633-A	K (VAR) BOARD, MOUNTED (KV-27FV17/29FV17/29FV17C ONLY)				*	A-1380-633-A	K (VAR) BOARD, MOUNTED (KV-27FV17/29FV17/29FV17C ONLY)			
						*	A-1380-632-A	K (VAR) BOARD, MOUNTED (KV-27FS13/27FV17/32FS13/32FS17/34FS13C/ 34FS17 ONLY)			
						CAPACITOR					
						C201	1-126-963-11	ELECT	4.7µF	20%	50V
						C202	1-126-963-11	ELECT	4.7µF	20%	50V
						C404	1-164-182-11	CERAMIC CHIP	0.0033µF	10%	50V
						C405	1-163-034-91	CERAMIC CHIP	0.033µF		50V
						C406	1-163-011-11	CERAMIC CHIP	0.0015µF	10%	50V
						C407	1-164-222-91	CERAMIC CHIP	0.22µF		25V
						C408	1-164-222-91	CERAMIC CHIP	0.22µF		25V
						C409	1-163-011-11	CERAMIC CHIP	0.0015µF	10%	50V
						C410	1-163-034-91	CERAMIC CHIP	0.033µF		50V
						C411	1-164-182-11	CERAMIC CHIP	0.0033µF	10%	50V
						C412	1-163-038-91	CERAMIC CHIP	0.1µF		25V
						C413	1-126-963-11	ELECT	4.7µF	20%	50V
						C414	1-126-963-11	ELECT	4.7µF	20%	50V
						C415	1-126-963-11	ELECT	4.7µF	20%	50V
						C416	1-126-963-11	ELECT	4.7µF	20%	50V
						C417	1-126-963-11	ELECT	4.7µF	20%	50V
						C418	1-163-038-91	CERAMIC CHIP	0.1µF		25V
						C419	1-164-346-11	CERAMIC CHIP	1µF		16V
						C422	1-126-963-11	ELECT	4.7µF	20%	50V
						C423	1-126-963-11	ELECT	4.7µF	20%	50V
						C424	1-164-005-11	CERAMIC CHIP (KV-27FV17/29FV17/29FV17C ONLY)	0.47µF		25V
						C425	1-164-346-11	CERAMIC CHIP (KV-27FV17/29FV17/29FV17C ONLY)	1µF		16V
						C426	1-126-960-11	ELECT (KV-27FV17/29FV17/29FV17C ONLY)	1µF	20%	50V
						C427	1-126-968-11	ELECT (KV-27FV17/29FV17/29FV17C ONLY)	100µF	20%	50V
						C428	1-126-968-11	ELECT (KV-27FV17/29FV17/29FV17C ONLY)	100µF	20%	50V
						CAPACITOR					
						C4050	1-104-665-11	ELECT	100µF	20%	25V
						CONNECTOR					
*	CN4050	1-564-520-11	PLUG,CONNECTOR 5P								
						DIODE					
						D4051	8-719-057-09	DIODE LNJ801LPDJA			
						HB					
*	A-1372-826-A	HB (VAR) BOARD, MOUNTED (KV-27FV17/29FV17/29FV17C ONLY)									
						CAPACITOR					
						CONNECTOR					
*	CN4050	1-564-520-11	PLUG,CONNECTOR 5P								
						DIODE					



COMPLETE PARTS LISTING

REF. NO.	PART NO.	DESCRIPTION	VALUES	REF. NO.	PART NO.	DESCRIPTION	VALUES
C429	1-163-017-00	CERAMIC CHIP (KV-27FV17/29FV17/29FV17C ONLY)	0.0047µF 10% 50V	JR419	1-216-295-91	SHORT (KV-27FV13/27FS17/32FS13/32FS17/34FS13C/ 34FS17 ONLY)	
C430	1-164-222-91	CERAMIC CHIP (KV-27FV17/29FV17/29FV17C ONLY)	0.22µF 25V	JR440	1-216-295-91	SHORT (KV-27FV13/27FS17/32FS13/32FS17/34FS13C/ 34FS17 ONLY)	
C431	1-163-038-91	CERAMIC CHIP (KV-27FV17/29FV17/29FV17C ONLY)	0.1µF 25V	JR460	1-216-295-91	SHORT (KV-27FV13/27FS17/32FS13/32FS17/34FS13C/ 34FS17 ONLY)	
C432	1-163-021-91	CERAMIC CHIP (KV-27FV17/29FV17/29FV17C ONLY)	0.01µF 10% 50V	JR420	1-216-295-91	SHORT	
C433	1-164-346-11	CERAMIC CHIP (KV-27FV17/29FV17/29FV17C ONLY)	1µF 16V	JR421	1-216-295-91	SHORT	
C434	1-163-038-91	CERAMIC CHIP (KV-27FV17/29FV17/29FV17C ONLY)	0.1µF 25V	JR422	1-216-295-91	SHORT	
C440	1-163-038-91	CERAMIC CHIP	0.1µF 25V	JR425	1-216-295-91	SHORT	
C441	1-126-933-11	ELECT	100µF 20% 16V	JR426	1-216-295-91	SHORT	
C446	1-126-933-11	ELECT	100µF 20% 16V	JR427	1-216-295-91	SHORT	
C450	1-126-963-11	ELECT	4.7µF 20% 50V	JR428	1-216-295-91	SHORT	
C451	1-126-963-11	ELECT	4.7µF 20% 50V	JR429	1-216-295-91	SHORT	
C455	1-164-005-11	CERAMIC CHIP (KV-27FV17/29FV17/29FV17C ONLY)	0.47µF 25V	JR474	1-216-295-91	SHORT	
C456	1-163-021-91	CERAMIC CHIP (KV-27FV17/29FV17/29FV17C ONLY)	0.01µF 10% 50V	JR491	1-216-295-91	SHORT	
C457	1-163-034-91	CERAMIC CHIP (KV-27FV17/29FV17/29FV17C ONLY)	0.033µF 50V			COIL	
C458	1-126-963-11	ELECT (KV-27FV17/29FV17/29FV17C ONLY)	4.7µF 20% 50V	L410	1-412-062-11	INDUCTOR	47µH
C460	1-126-963-11	ELECT (KV-27FV17/29FV17/29FV17C ONLY)	4.7µF 20% 50V			TRANSISTOR	
C475	1-163-038-91	CERAMIC CHIP	0.1µF 25V	Q430	8-729-422-27	TRANSISTOR 2SD601A-QRS-TX	
C490	1-216-295-91	SHORT		Q431	8-729-422-27	TRANSISTOR 2SD601A-QRS-TX	
		CONNECTOR		Q432	8-729-424-02	TRANSISTOR 2SB709A-QRS-TX	
* CN402	1-564-506-11	PLUG,CONNECTOR 3P		Q433	8-729-424-02	TRANSISTOR 2SB709A-QRS-TX	
CN450	1-573-301-21	CONNECTOR, BOARD TO BOARD 20P				RESISTOR	
CN451	1-564-505-11	PLUG,CONNECTOR 2P		R403	1-216-295-91	SHORT	
		IC		R404	1-216-025-11	RES-CHIP	100 5% 1/10W
IC403	8-759-658-19	IC NJM2198-TE2 (KV-27FV17/29FV17/29FV17C ONLY)		R405	1-216-025-11	RES-CHIP	100 5% 1/10W
IC404	8-759-697-77	IC NJW1130AG-TE2		R407	1-216-025-11	RES-CHIP	100 5% 1/10W
		CHIP CONDUCTOR		R409	1-216-025-11	RES-CHIP	100 5% 1/10W
JR402	1-216-295-91	SHORT (KV-27FV17/29FV17/29FV17C ONLY)		R410	1-216-025-11	RES-CHIP	100 5% 1/10W
JR403	1-216-295-91	SHORT		R431	1-216-073-91	RES-CHIP	10K 5% 1/10W
JR404	1-216-295-91	SHORT		R432	1-216-073-91	RES-CHIP	10K 5% 1/10W
JR407	1-216-295-91	SHORT (KV-27FV13/27FS17/32FS13/32FS17/34FS13C/ 34FS17 ONLY)		R433	1-216-295-91	SHORT	
JR408	1-216-295-91	SHORT (KV-27FV13/27FS17/32FS13/32FS17/34FS13C/ 34FS17 ONLY)		R434	1-216-065-91	RES-CHIP	4.7K 5% 1/10W
				R435	1-216-033-00	RES-CHIP	220 5% 1/10W
				R436	1-216-065-91	RES-CHIP	4.7K 5% 1/10W
				R437	1-216-033-00	RES-CHIP	220 5% 1/10W
				R438	1-216-033-00	RES-CHIP	220 5% 1/10W
				R442	1-216-033-00	RES-CHIP	220 5% 1/10W
				R443	1-216-105-91	RES-CHIP	220K 5% 1/10W
				R444	1-216-105-91	RES-CHIP	220K 5% 1/10W
				R445	1-216-105-91	RES-CHIP	220K 5% 1/10W
				R446	1-216-105-91	RES-CHIP	220K 5% 1/10W
				R452	1-216-073-91	RES-CHIP	10K 5% 1/10W
						(KV-27FV17/29FV17/29FV17C ONLY)	
				R455	1-216-081-00	RES-CHIP	22K 5% 1/10W



REF. NO.	PART NO.	DESCRIPTION	VALUES	REF. NO.	PART NO.	DESCRIPTION	VALUES
R456	1-216-081-00	RES-CHIP	22K 5% 1/10W				
R468	1-216-295-91	SHORT					
R469	1-216-295-91	SHORT					
R470	1-216-025-11	RES-CHIP	100 5% 1/10W				
ACCESSORIES AND PACKAGING				REMOTE COMMANDER			
*	4-041-255-01	BAG, PROTECTION (KV-27FS13/27FS17/ 27FV17/ 29FV17/29FV17C ONLY)		1-476-680-11		REMOTE COMMANDER (RM-Y180) (KV-27FS13/32FS13/34FS13C ONLY)	
*	4-041-259-01	BAG, PROTECTION (KV-32FS13/32FS17/34FS13C/34FS17 ONLY)		1-476-681-11		REMOTE COMMANDER (RM-Y181) (KV-27FS17/32FS17/34FS17/27FV17/29FV17/ 29FV17C ONLY)	
*	4-075-517-01	CARTON, INDIVIDUAL (KV-27FV17 ONLY)		4-978-977-11		BATTERY COVER (RM-Y180, RM-Y181)	
*	4-075-524-01	CARTON, INDIVIDUAL (KV-29FV17/29FV17C ONLY)					
*	4-074-568-05	CARTON, INDIVIDUAL (KV-27FS13/27FS17 ONLY)					
*	4-083-277-01	CARTON, INDIVIDUAL (KV-32FS13/32FS17/34FS13C/34FS17 ONLY)					
	4-081-082-01	CUSHION, UPPER (KV-27FS13/27FS17 ONLY)					
	4-081-083-01	CUSHION, LOWER (KV-27FS13/27FS17 ONLY)					
*	4-073-715-02	CUSHION ASSY, UPPER (KV-32FS13/32FS17/34FS13C/34FS17 ONLY)					
*	4-073-716-02	CUSHION ASSY, LOWER (KV-32FS13/32FS17/34FS13C/34FS17 ONLY)					
	4-075-515-01	CUSHION ASSY, UPPER (KV-27FV17/29FV17/29FV17C ONLY)					
	4-075-516-01	CUSHION ASSY, LOWER (KV-27FV17/29FV17/29FV17C ONLY)					
	4-081-737-21	MANUAL, INSTRUCTION (KV-27FS13/27FS17/27FV17/32FS13/32FS17 ONLY)					
	4-081-738-41	MANUAL, INSTRUCTION (KV-29FV17/29FV17C ONLY)					
	4-081-737-31	MANUAL, INSTRUCTION (KV-27FS13CND/27FV17CND/32FS13CND ONLY)					
	4-081-739-41	MANUAL, INSTRUCTION (KV-34FS13C/34FS17 ONLY)					

Sony Corporation
Sony Technology Center
Technical Services
Service Promotion Department

English
2000CS74111-1
Printed in USA
© 2001.3

A BOARD SCHEMATIC DIAGRAM (KV-27FS13/27FS17/32FS13/32FS17/34FS13C/34FS17 ONLY)

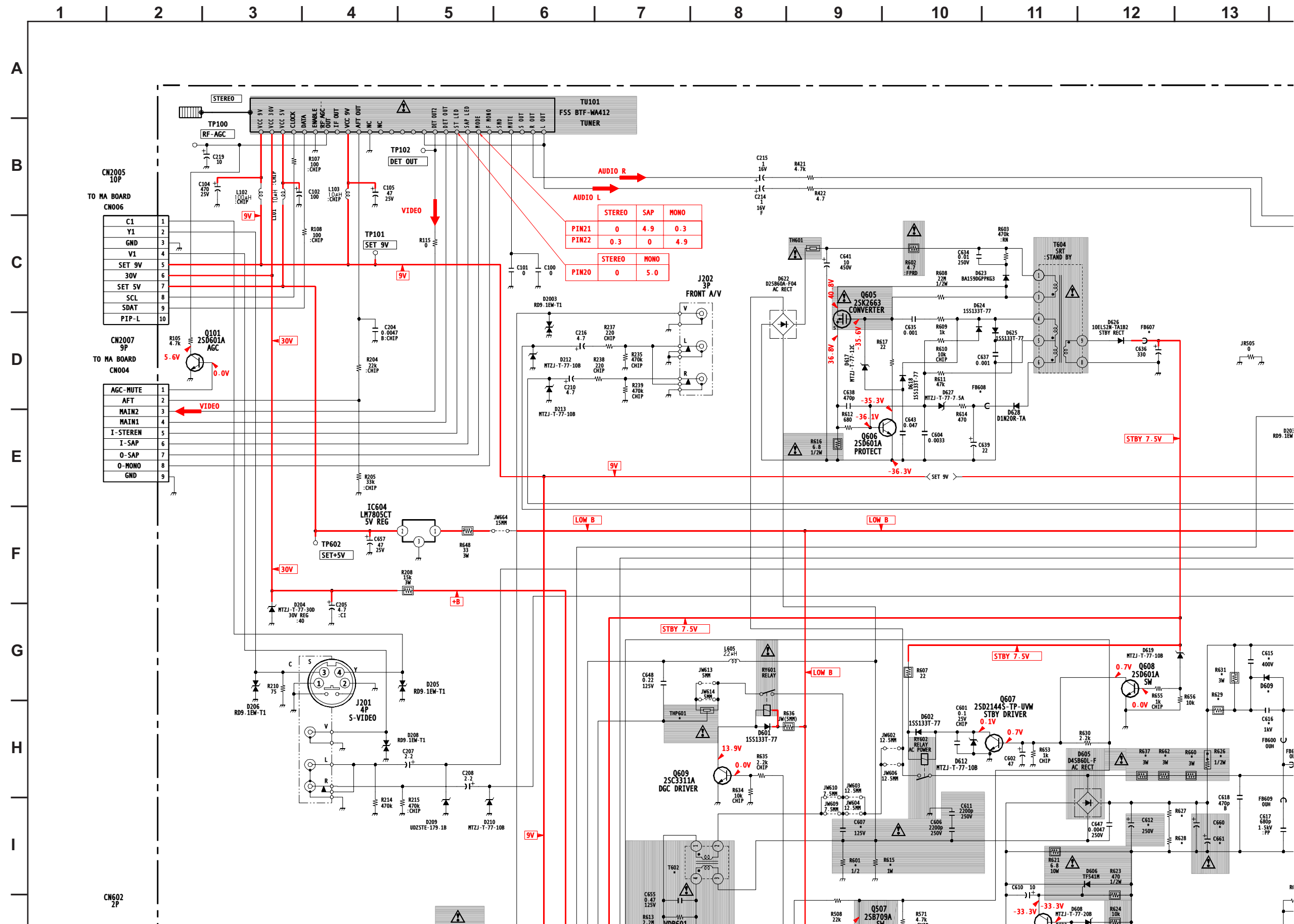

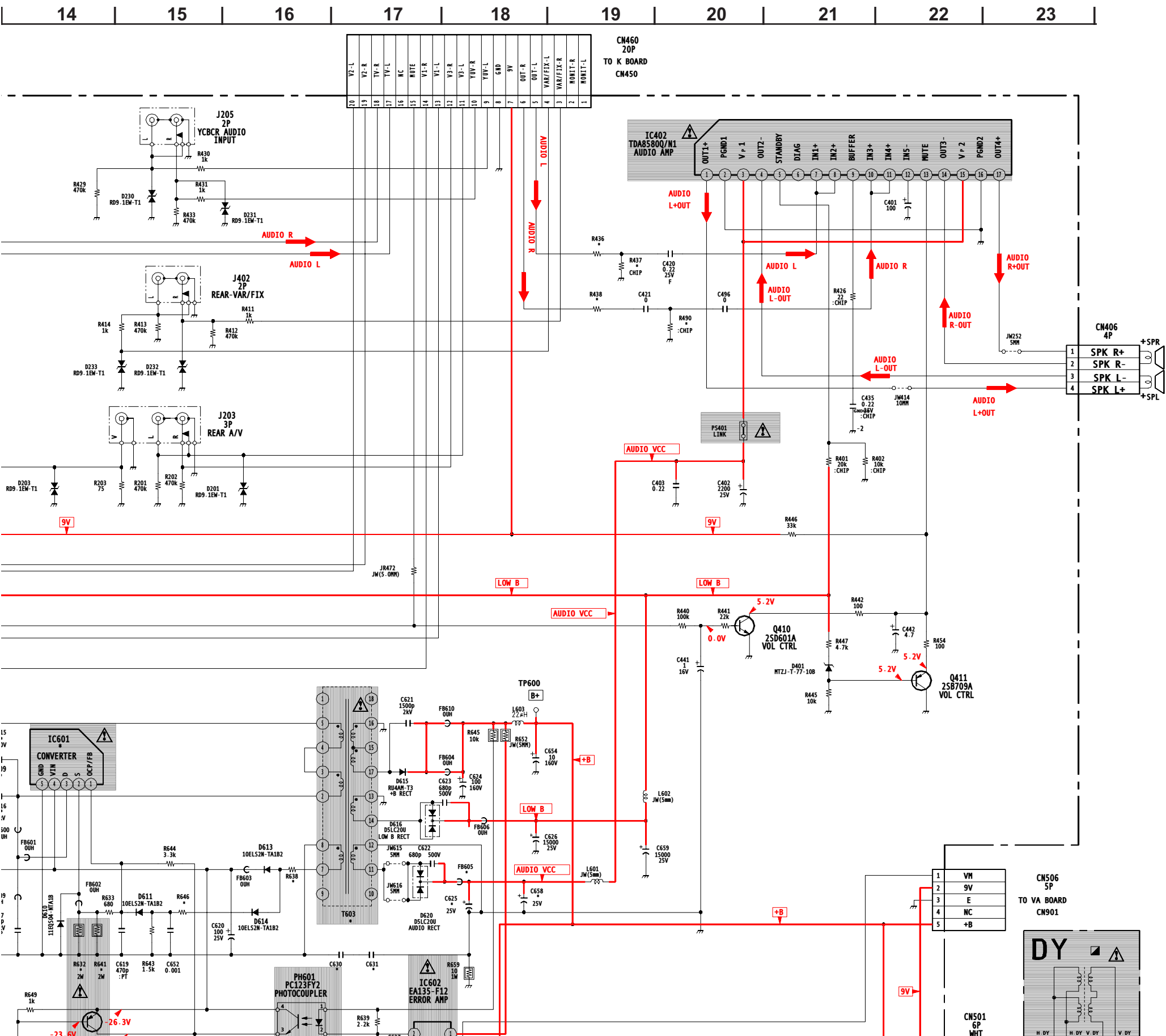

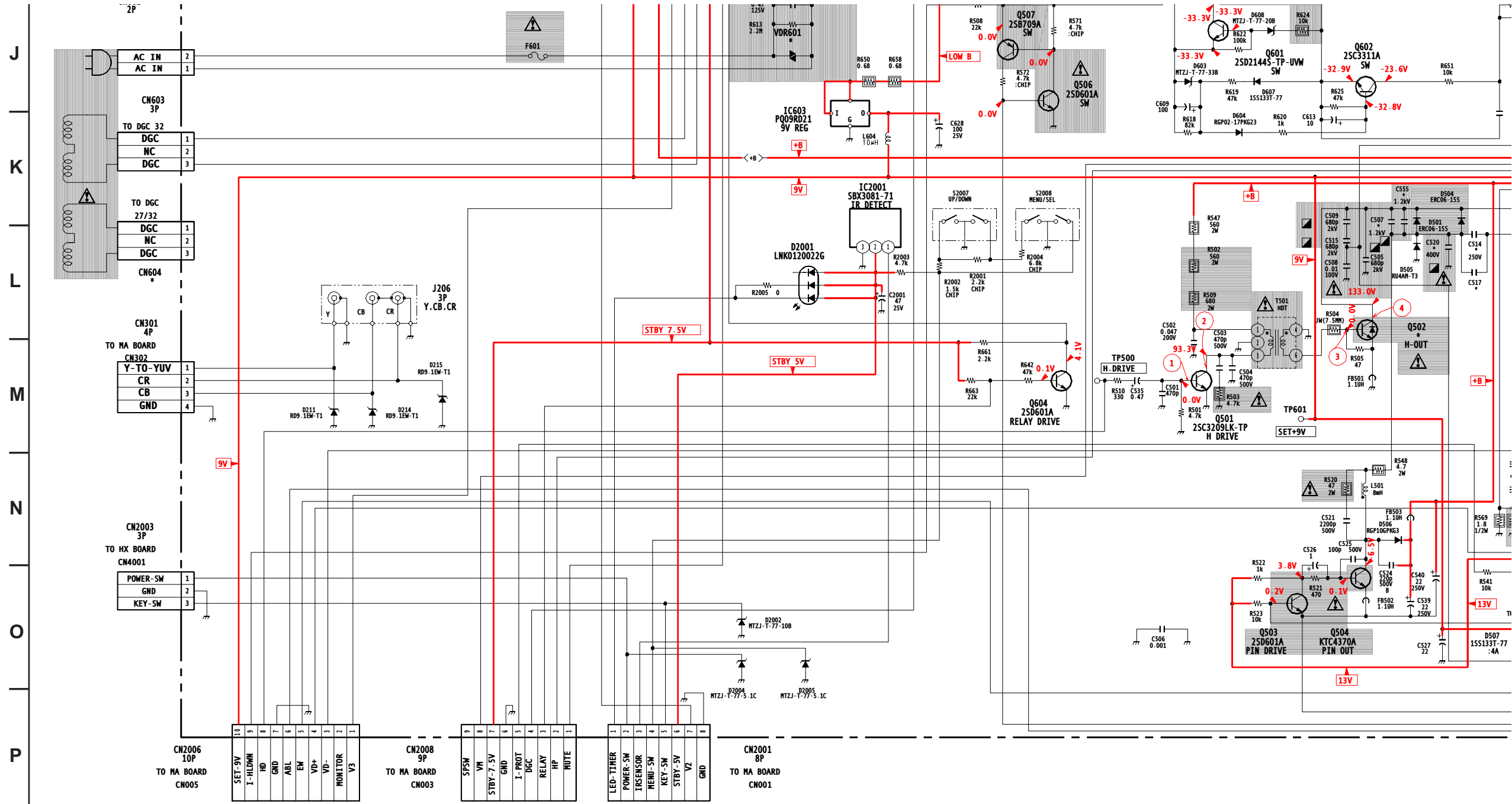

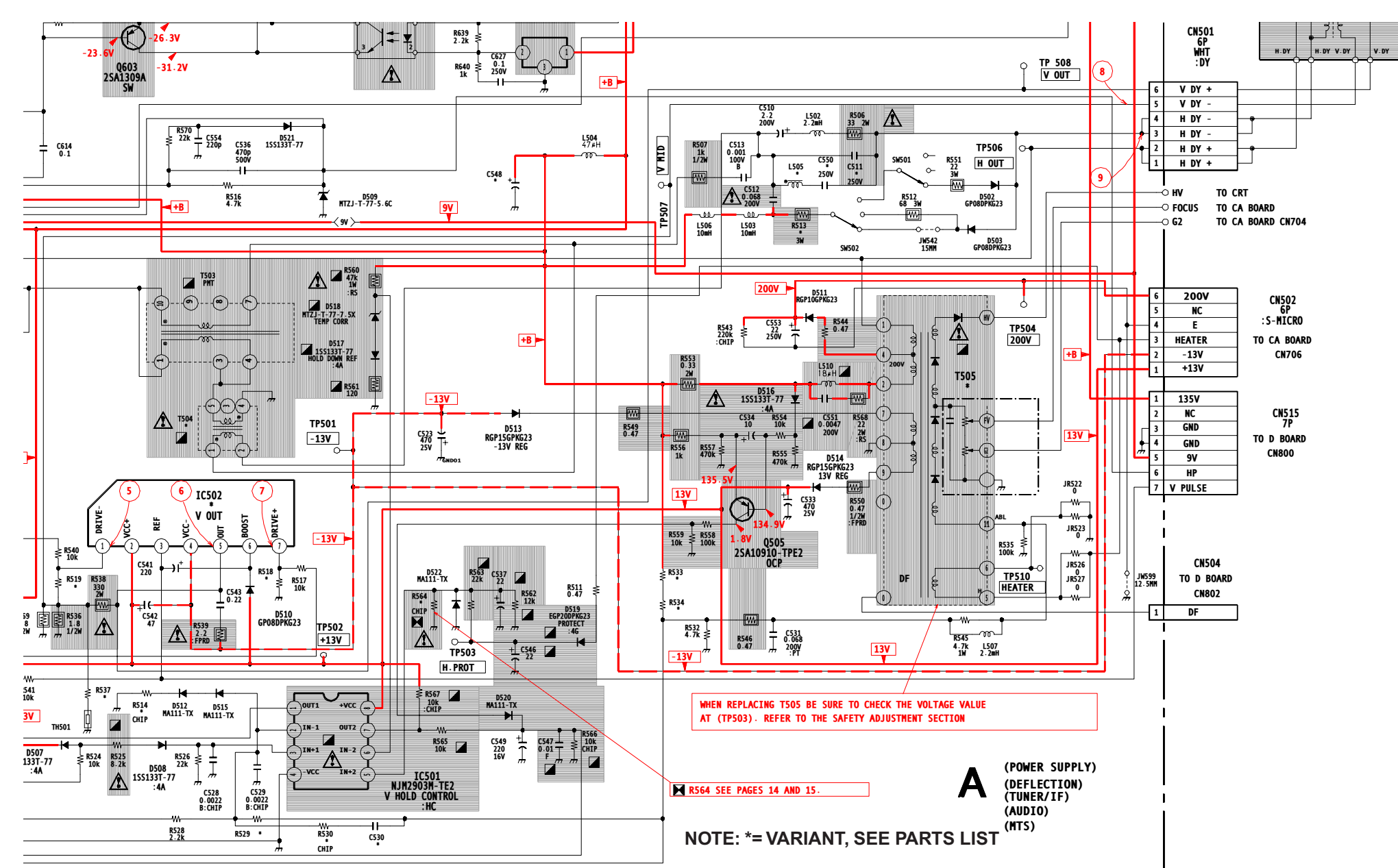

WHEN REPLACING T505 BE SURE TO CHECK THE VOLTAGE VALUE AT (TP503) . REFER TO THE SAFETY ADJUSTMENT SECTION

RS64 SEE PAGES 14 AND 15.

A (POWER SUPPLY)
(DEFLECTION)
(TUNER/IF)
(AUDIO)
(MTS)

NOTE: *= VARIANT, SEE PARTS LIST

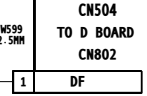
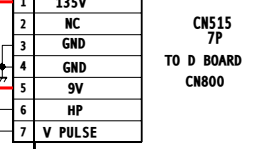
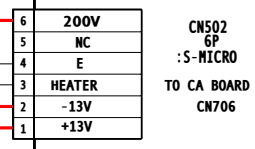
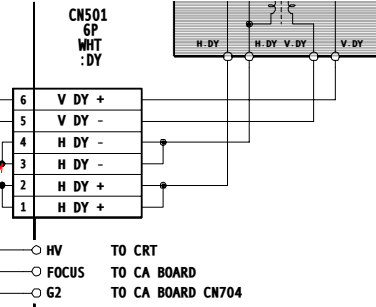

A BOARD SCHEMATIC DIAGRAM (KV-27FV17/29FV17/29FV17C ONLY)

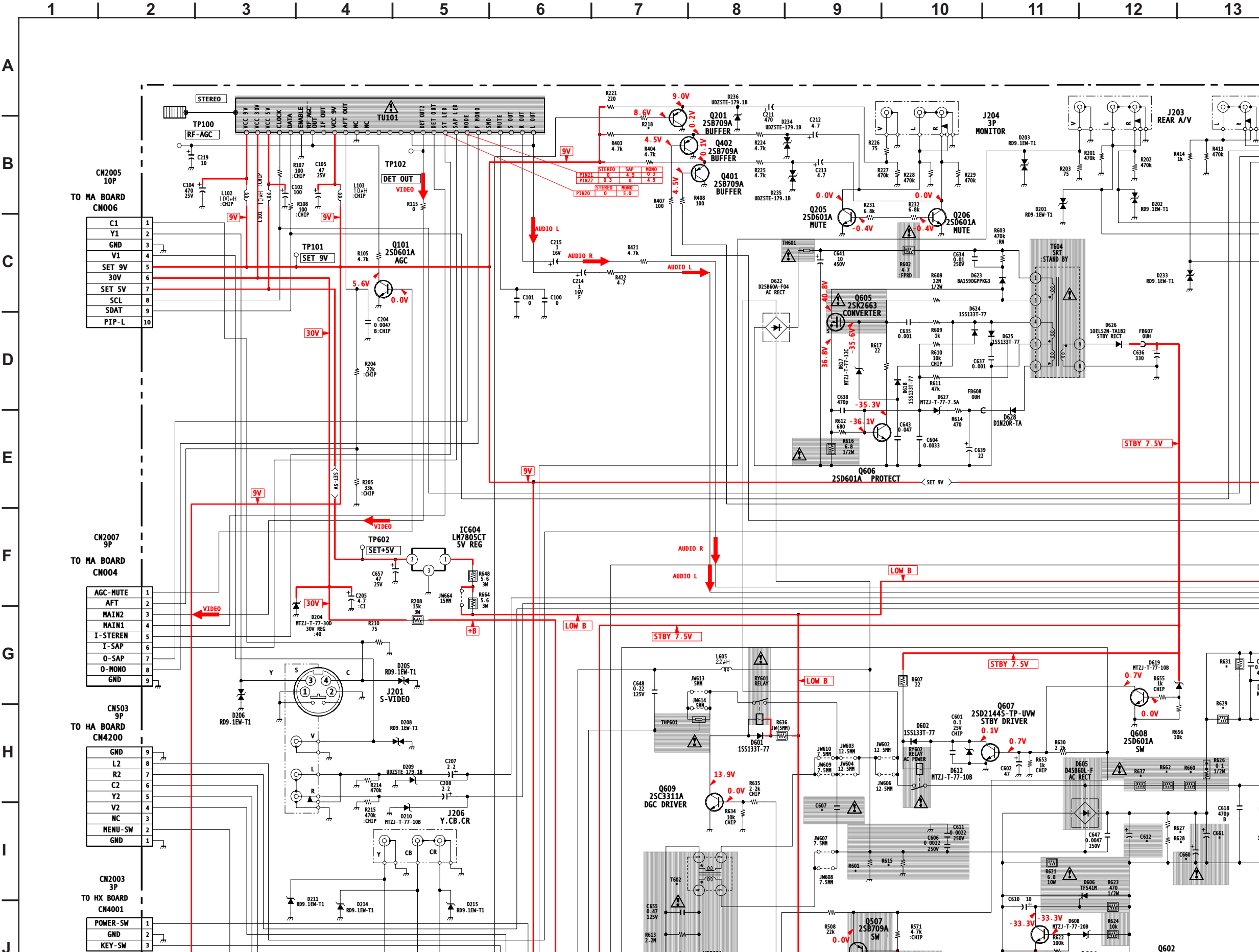

3 | 14 | 15 | 16 | 17 | 18 | 19 | 20 | 21 | 22 | 23

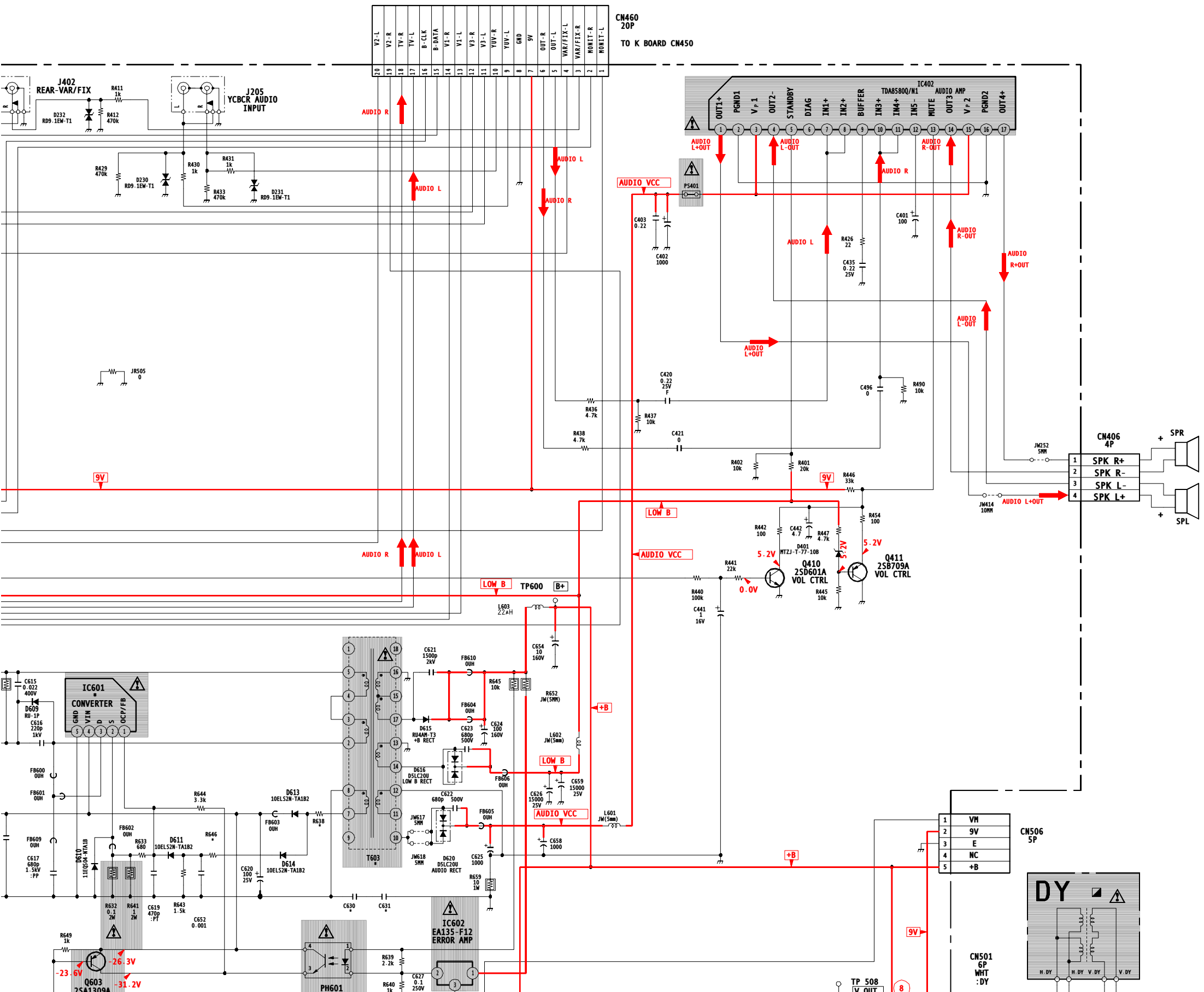

J
K
L
M
N
O
P

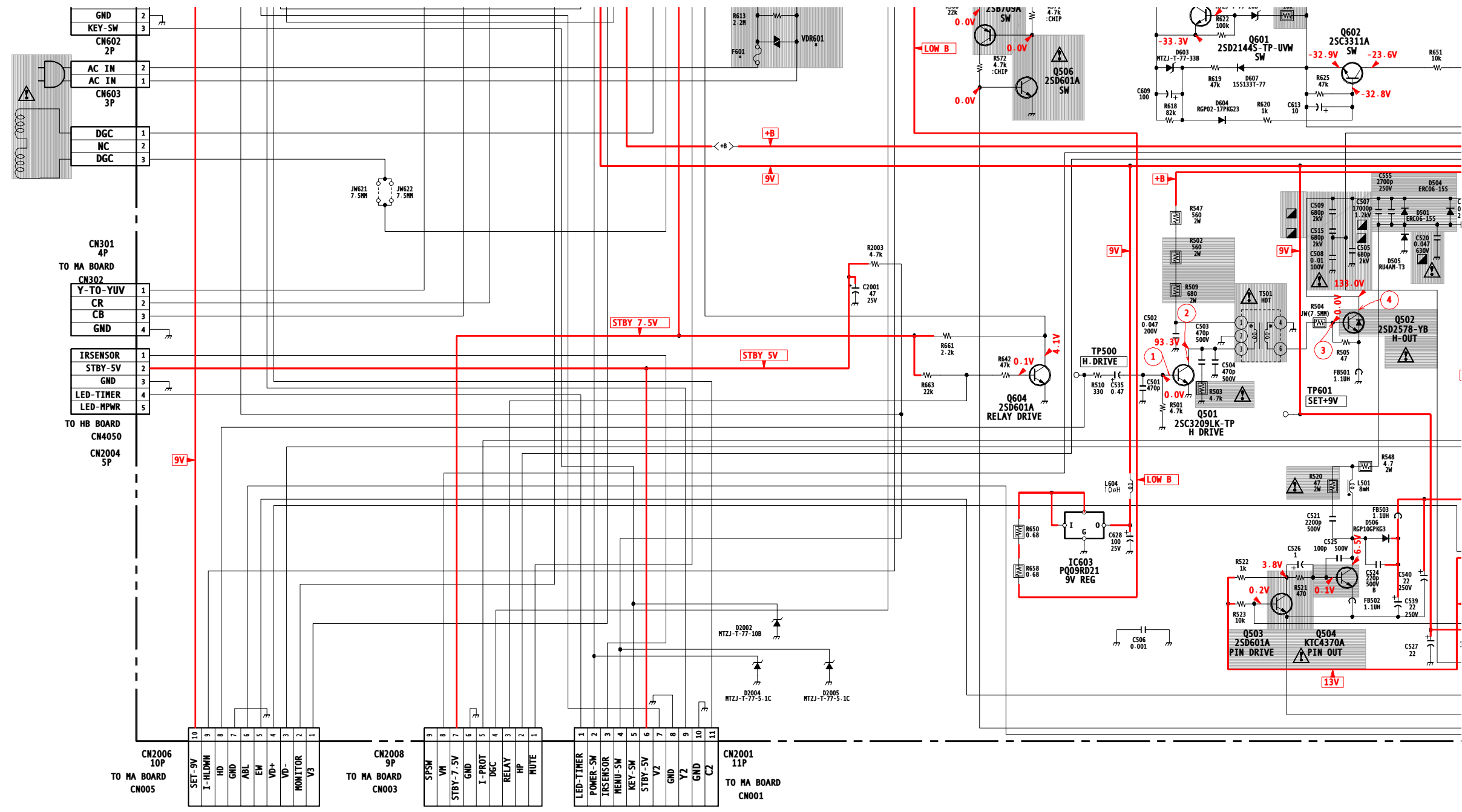

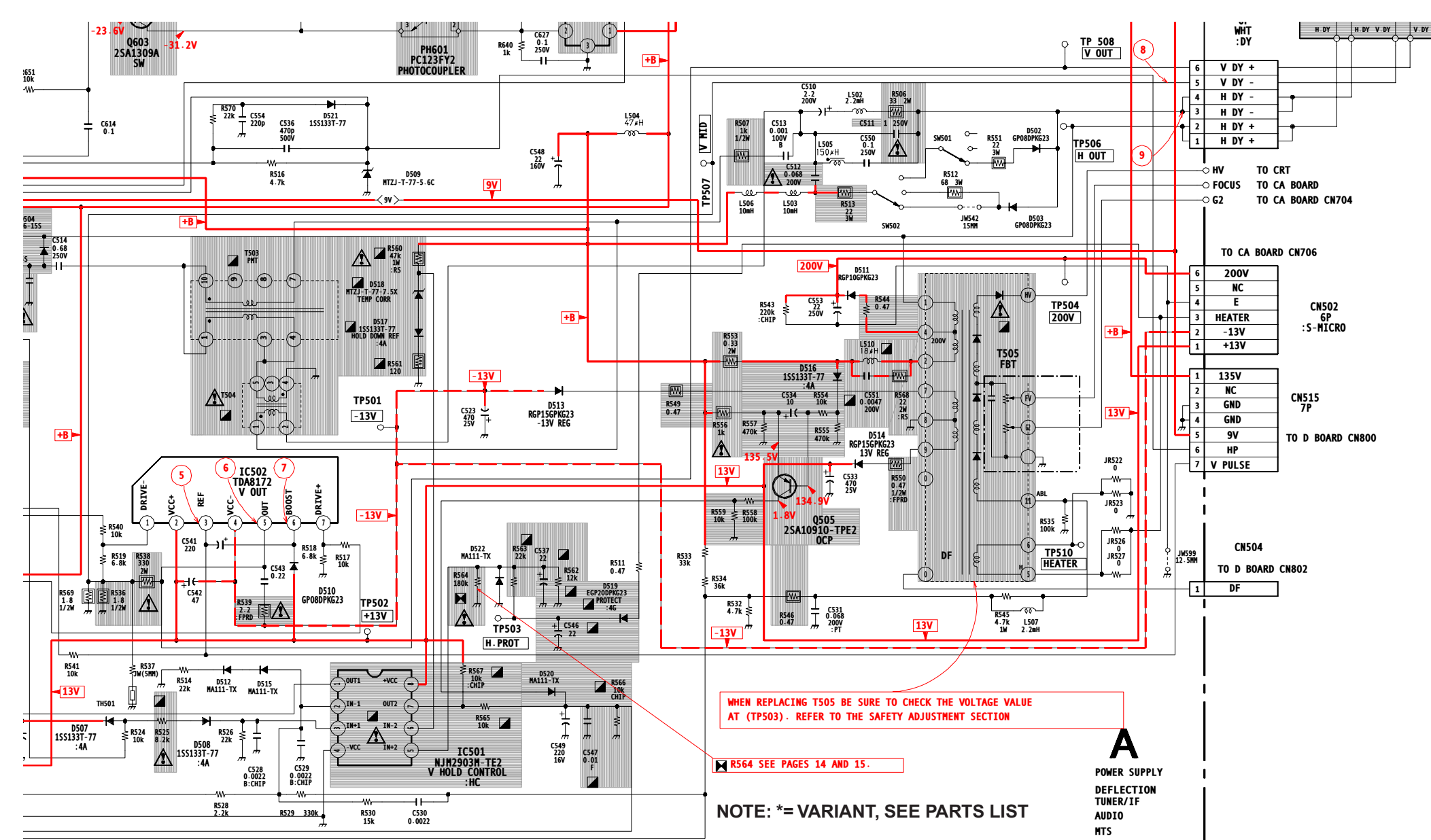

WHEN REPLACING TS05 BE SURE TO CHECK THE VOLTAGE VALUE AT (TP503) . REFER TO THE SAFETY ADJUSTMENT SECTION

R564 SEE PAGES 14 AND 15.

NOTE: *= VARIANT, SEE PARTS LIST

A
POWER SUPPLY
DEFLECTION
TUNER/IF
AUDIO
MTS

MA BOARD SCHEMATIC DIAGRAM (KV-27FS13/27FS17/32FS13/32FS17/34FS13C/34FS17 ONLY)

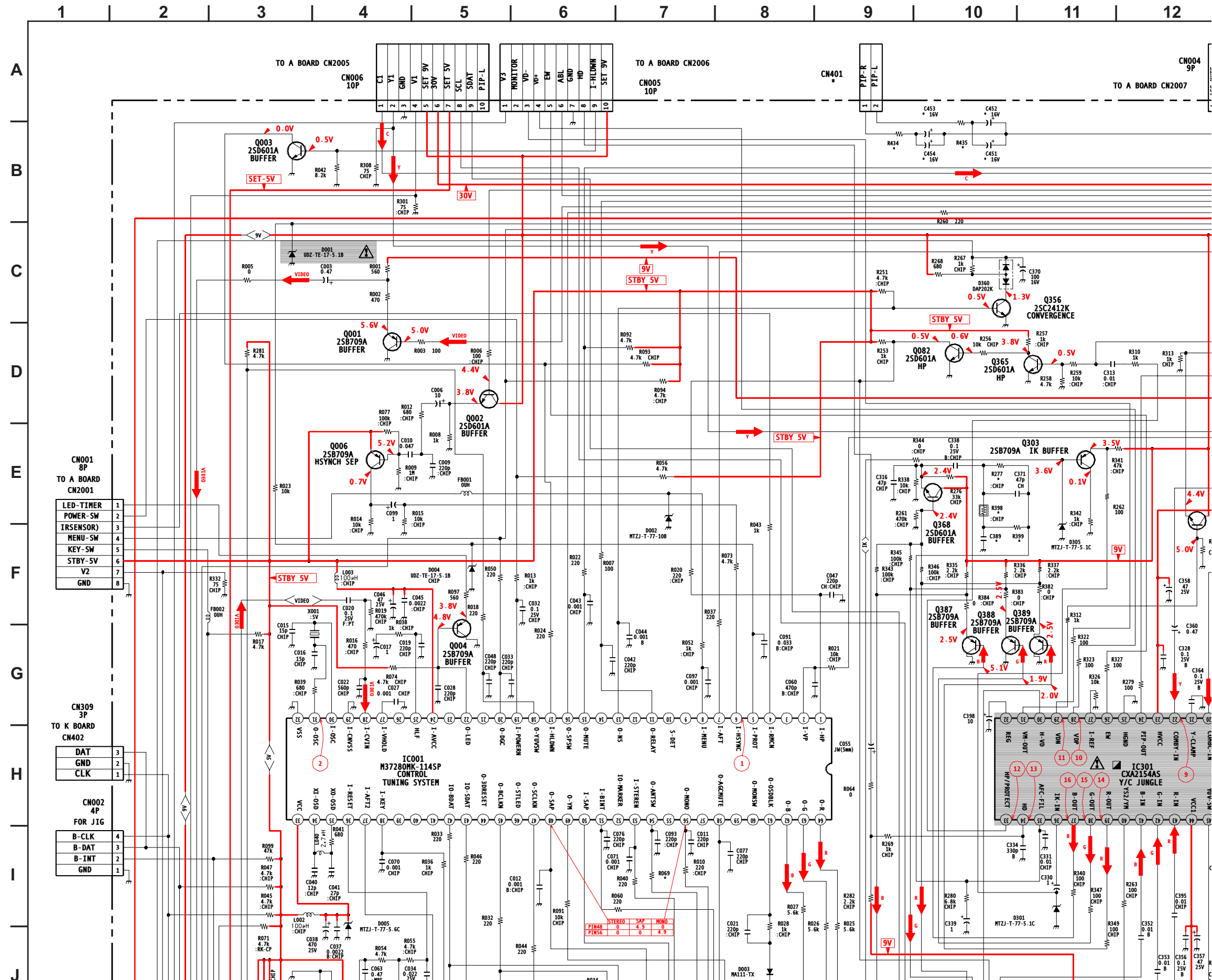

CN001
 8P
 TO A BOARD
 CN2001

LED-TIMER	1
POWER-SW	2
IRSENSOR	3
MENU-SW	4
KEY-SW	5
STBY-5V	6
V2	7
GND	8

CN309
 3P
 TO K BOARD
 CN402

DAT	3
GND	2
CLK	1

CN002
 4P
 FOR JIG

B-CLK	4
B-DAT	3
B-INT	2
GND	1

STEREO	0	0	0	0
SAP	0	0	0	0
MONO	0	0	0	0
PT1848	0	0	0	0
PT1856	0	0	0	0

13 14 15 16 17 18 19 20 21 22 23

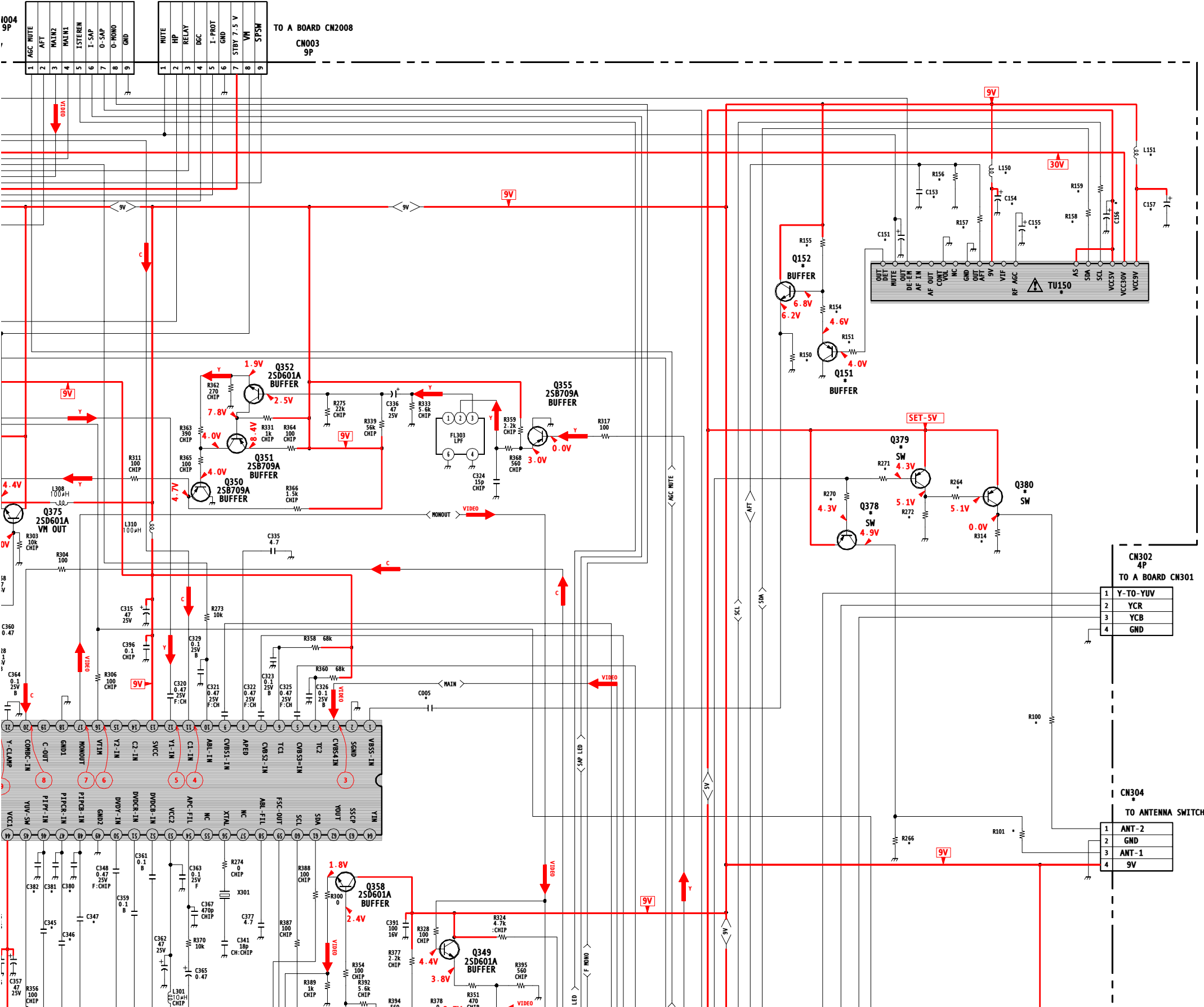

J
K
L
M
N
O
P

CN303
9P
TO CA BOARD
CN705

H-TRAP	9
NS-MUTE	8
N/S	7
GND	6
G	5
B	4
R	3
GND	2
I-K	1

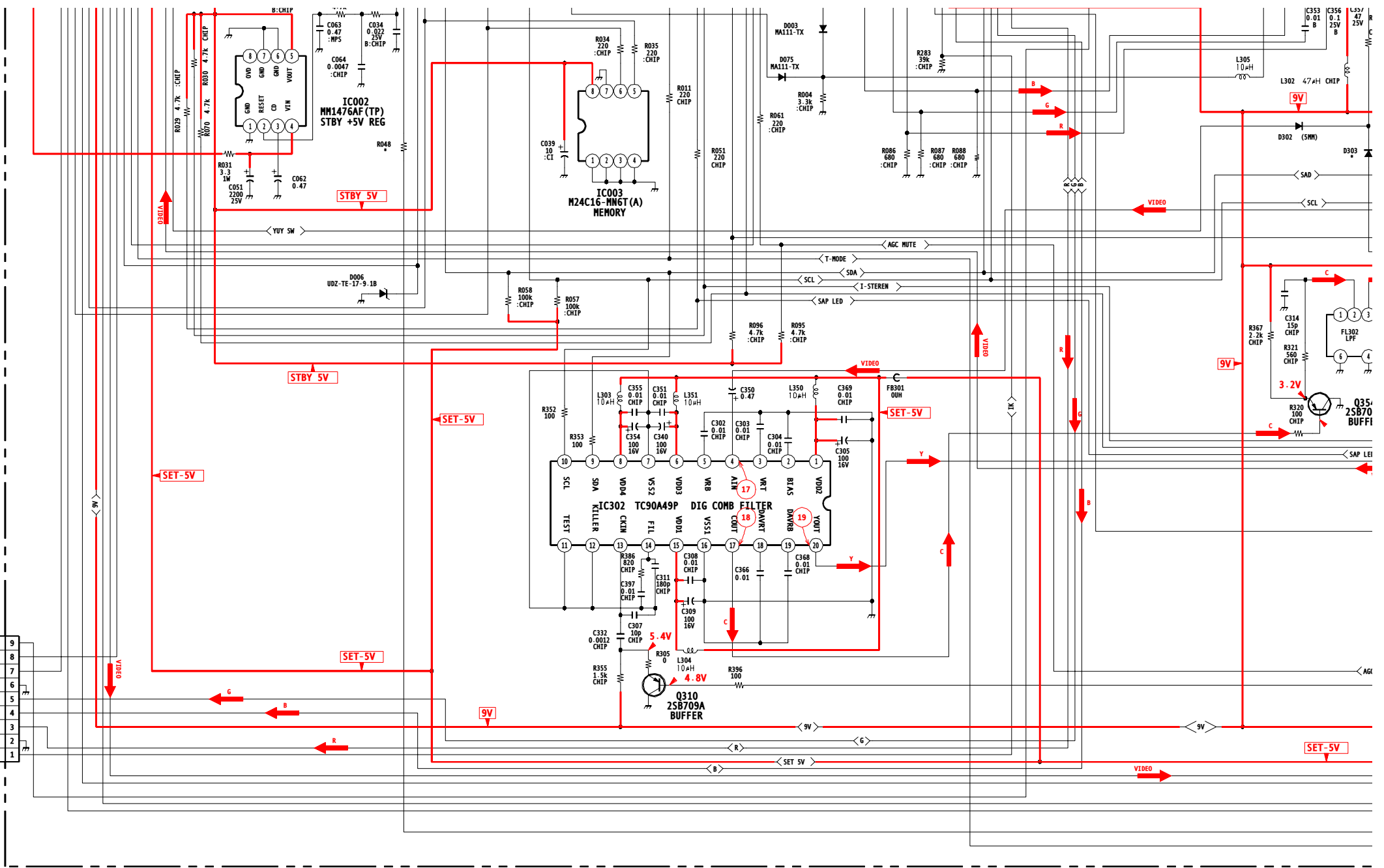

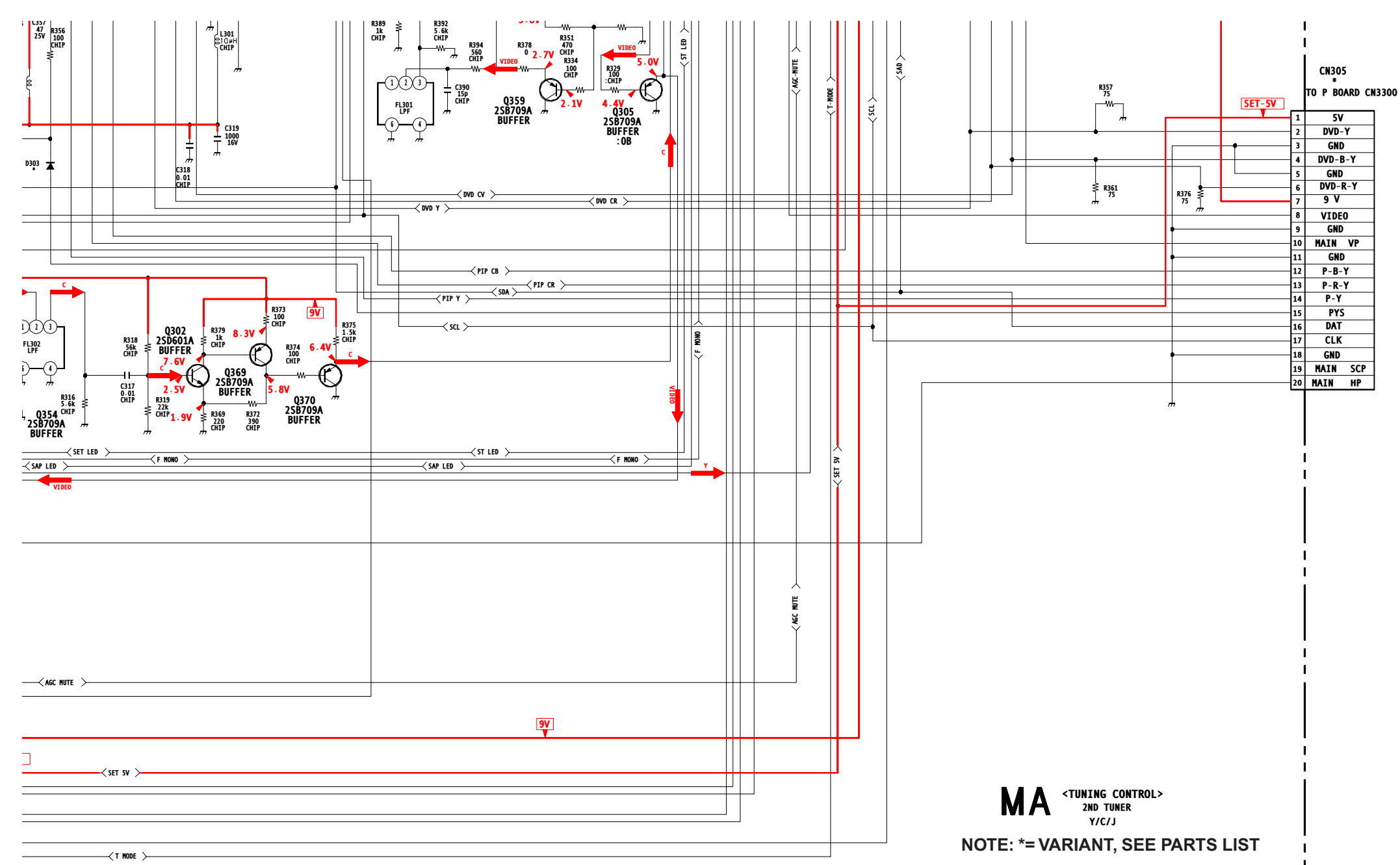

MA <TUNING CONTROL>
2ND TUNER
Y/C/J

NOTE: *= VARIANT, SEE PARTS LIST

MA BOARD SCHEMATIC DIAGRAM (KV-27FV17/29FV17/29FV17C ONLY)

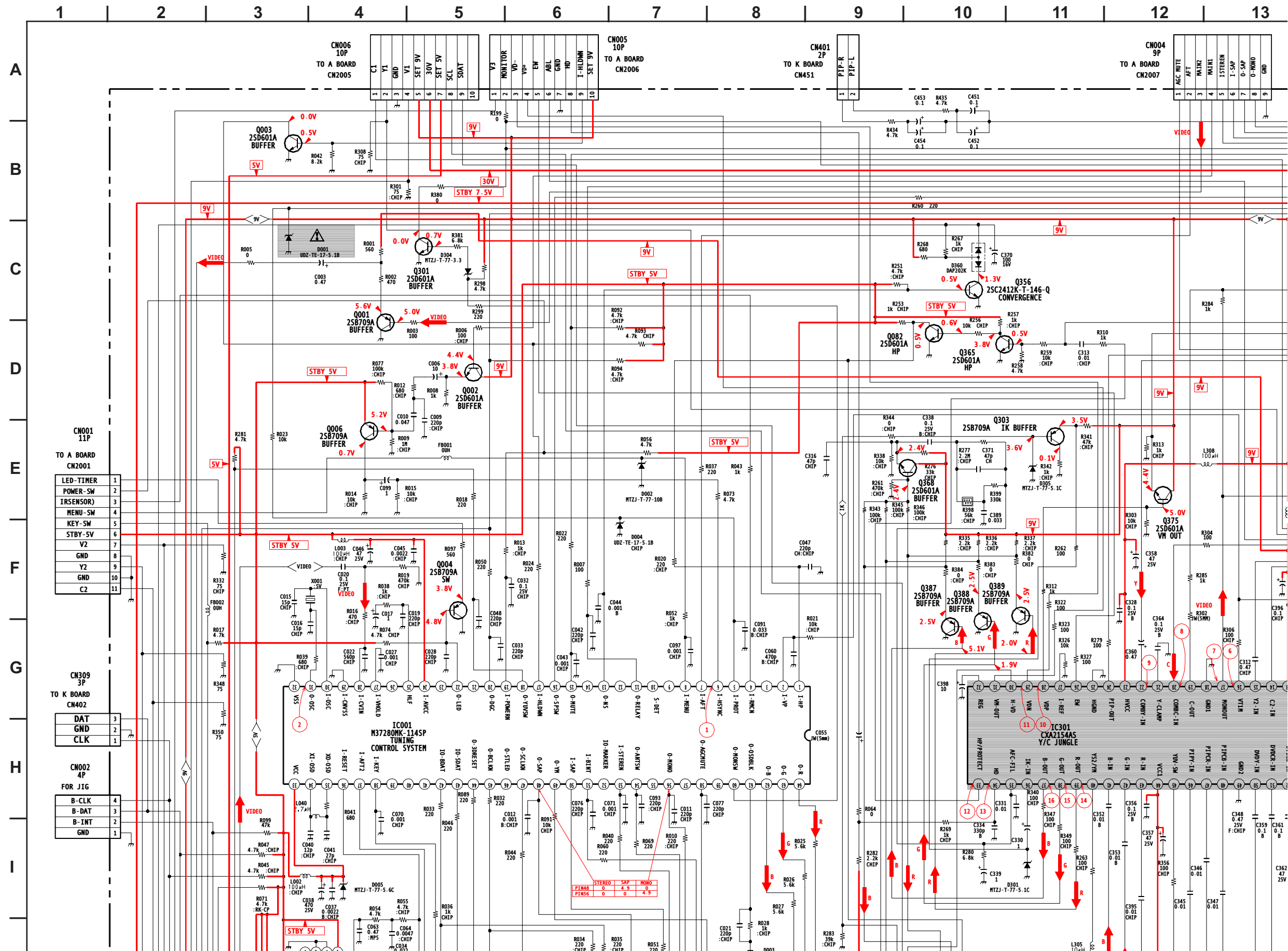

3 | 14 | 15 | 16 | 17 | 18 | 19 | 20 | 21 | 22 | 23

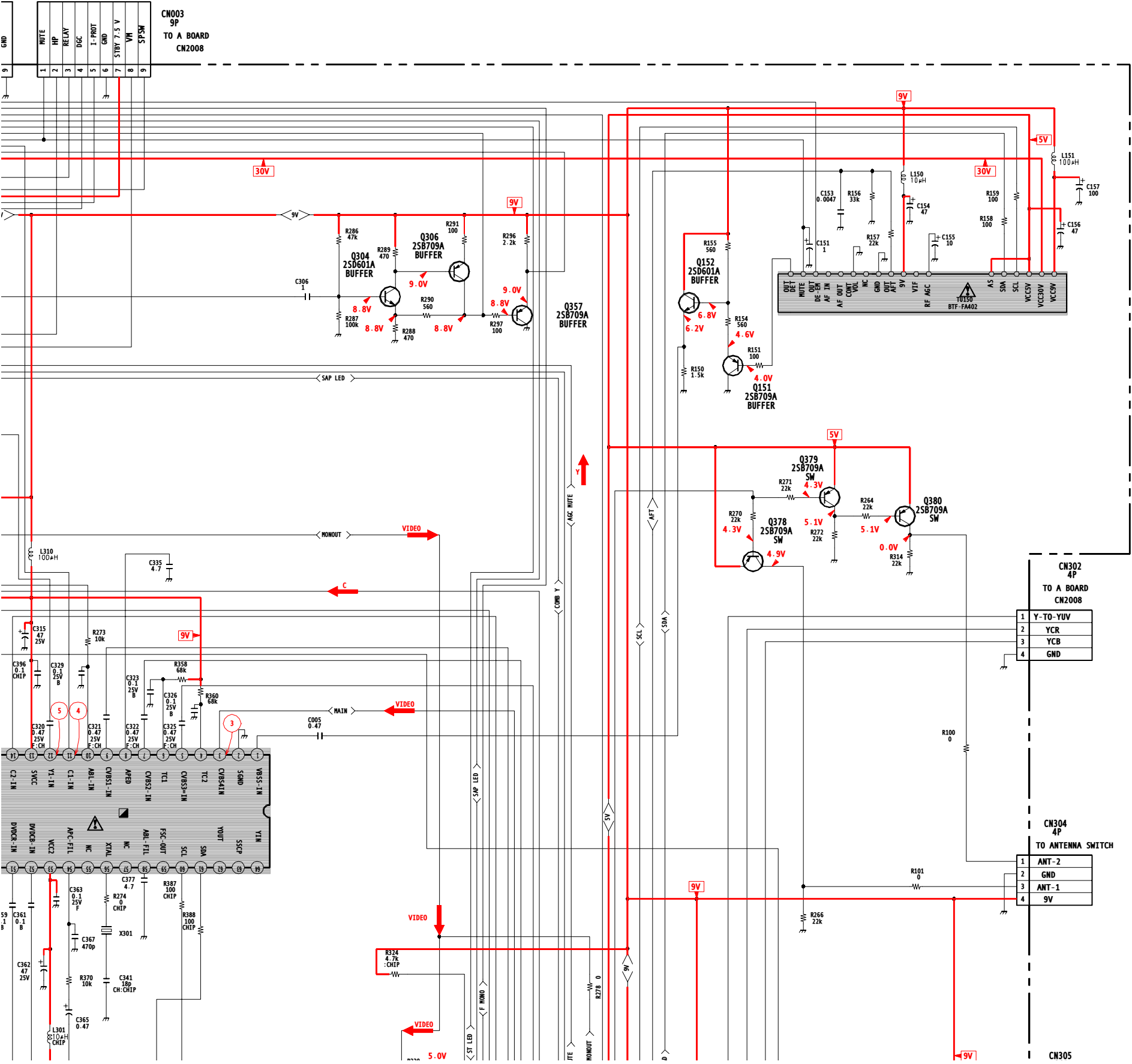

CN003
9P
TO A BOARD
CN2008

CN302
4P
TO A BOARD
CN2008

CN304
4P
TO ANTENNA SWITCH

CN305

- 1 Y-TO-YUV
- 2 YCR
- 3 YCB
- 4 GND

- 1 ANT-2
- 2 GND
- 3 ANT-1
- 4 9V

J
K
L
M
N
O
P

CN303
9P
TO CA BOARD
CN705

H-TRAP	9
NS-MUTE	8
M/S	7
GND	6
G	5
B	4
R	3
GND	2
I-K	1

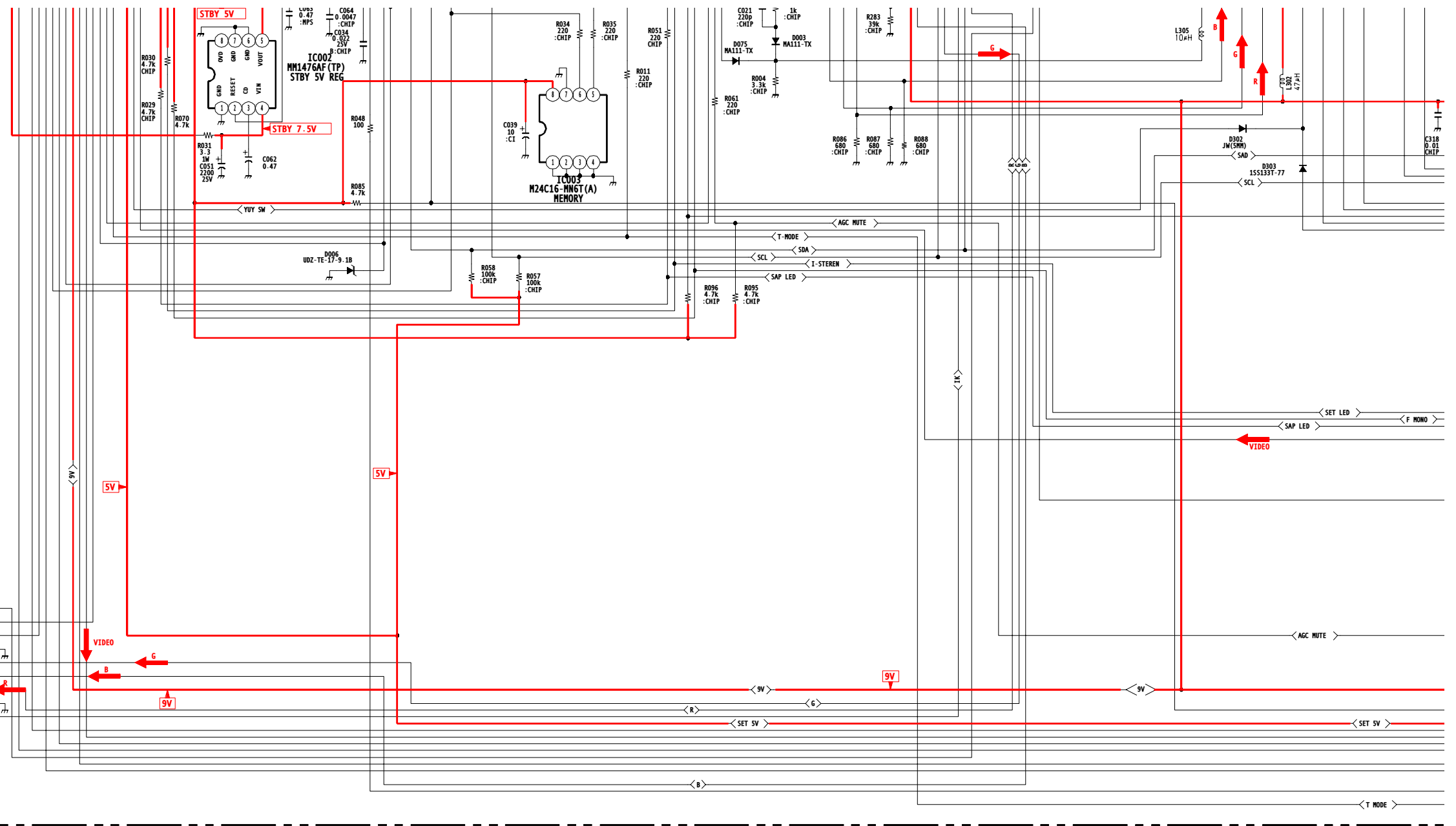

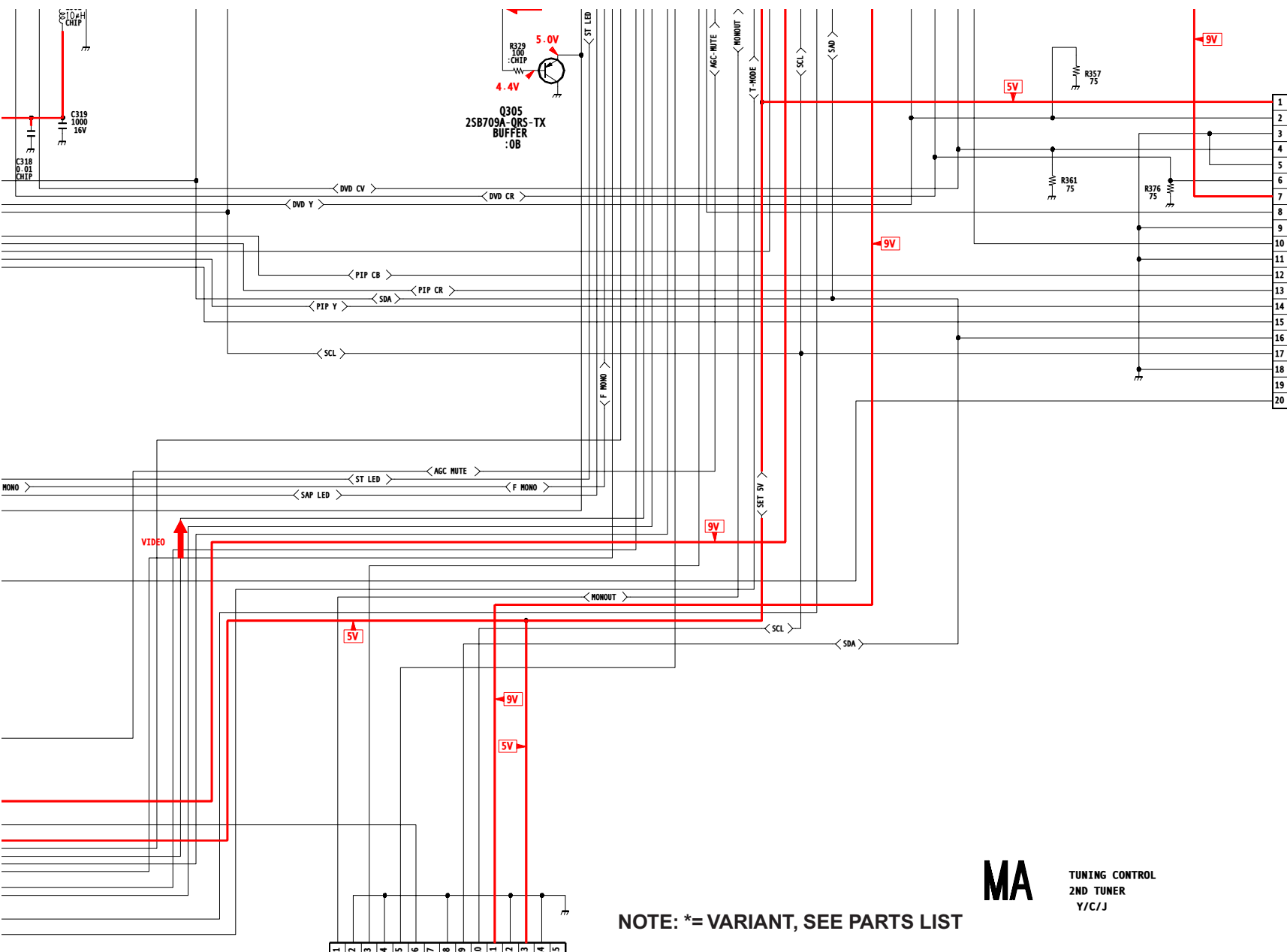

CN305
20P
TO P BOARD
CN3300

1	5V
2	DVD-Y
3	GND
4	DVD-B-Y
5	GND
6	DVD-R-Y
7	9V
8	VIDEO
9	GND
10	MAIN VP
11	GND
12	P-B-Y
13	P-R-Y
14	P-Y
15	PYS
16	DAT
17	CLK
18	GND
19	MAIN SCP
20	MAIN HP

CN306
15P
TO BC BOARD
CN3500

1	CVIN
2	GND
3	CONRY
4	GND
5	COMB-C
6	RESET
7	YIN
8	GND
9	DAT
10	CLK
11	9V
12	GND
13	5V
14	GND
15	CTW

NOTE: *= VARIANT, SEE PARTS LIST

MA
TUNING CONTROL
2ND TUNER
Y/C/J

SONY®

4-081-737-21



FD Trinitron
WEGA

Trinitron® Color TV

Operating Instructions

KV-27FS13
KV-27FS17
KV-27FV17
KV-32FS13
KV-32FS17

© 2001 by Sony Corporation

WARNING

To reduce the risk of fire or electric shock, do not expose the TV to rain or moisture.

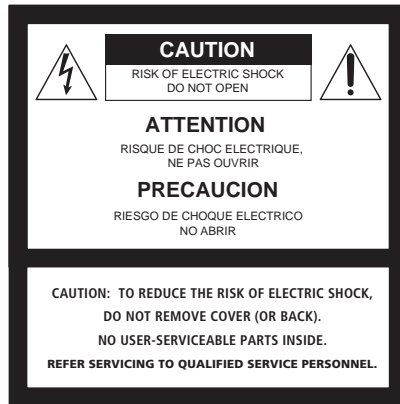

This symbol is intended to alert the user to the presence of uninsulated “dangerous voltage” within the product’s enclosure that may be of sufficient magnitude to constitute a risk of electric shock to persons.



This symbol is intended to alert the user to the presence of important operating and maintenance (servicing) instructions in the literature accompanying the appliance.

Note to the CATV Installer

This reminder is provided to call the CATV system installer’s attention to Article 820-40 of the NEC that provides guidelines for proper grounding and, in particular, specifies that the cable ground shall be connected to the grounding system of the building as close to the point of cable entry as practical.

SAFETY PRECAUTIONS

- Operate the TV only on 120 V AC.
- One blade of the power plug is wider than the other for safety purposes and will fit into the power outlet only one way. If you are unable to insert the plug fully into the outlet, contact your dealer.
- If any liquid or solid object falls into the TV, unplug it and have it checked by qualified personnel before operating it further.

CAUTION

When using TV games, computers, and similar products with your TV, keep the brightness and contrast functions at low settings. If a fixed (non-moving) pattern is left on the screen for long periods of time at a high brightness or contrast setting, the image can be permanently imprinted onto the screen. Continuously watching the same channel can cause the imprint of station logos onto the TV screen. These types of imprints are not covered by your warranty because they are the results of misuse.



To reduce the risk of electric shock, do not use this polarized plug with an extension cord, receptacle, or other outlet unless the blades can be fully inserted to prevent blade exposure.



You are cautioned that any changes or modifications not expressly approved in this manual could void your authority to operate this equipment.

NOTIFICATION

This equipment has been tested and found to comply with the limits for a Class B digital device pursuant to Part 15 of the FCC Rules. These limits are designed to provide reasonable protection against harmful interference in a residential installation. This equipment generates, uses, and can radiate radio frequency energy and, if not installed and used in accordance with the instructions, may cause harmful interference with radio communications. However, there is no guarantee that interference will not occur in a particular installation. If this equipment does cause harmful interference to radio or television reception, which can be determined by turning the equipment off and on, the user is encouraged to try to correct the interference by one or more of the following measures:

- Reorient or relocate the receiving antennas.
- Increase the separation between the equipment and receiver.
- Connect the equipment into an outlet on a circuit different from that to which the receiver is connected.
- Consult the dealer or an experienced radio/TV technician for help.

Protecting the TV

- To prevent internal heat build-up, do not block the ventilation openings.
- Do not install the TV in a hot or humid place, or in a place subject to excessive dust or mechanical vibration.

Note on Caption Vision

This television receiver provides display of television closed captioning in accordance with § 15.119 of the FCC rules.

Use of this television for other than private viewing of programs broadcast on UHF or VHF or transmitted by cable companies for the use of the general public may require authorization from the broadcaster-cable company and/or program owner.

Owner's Record

The model and serial numbers are located on the front cover of this manual and the rear of your TV.

Trademarks and Copyrights

ENERGY STAR® is a registered mark.



As an ENERGY STAR® Partner, Sony has determined that this product or product models meet the ENERGY STAR® guidelines for energy efficiency.

Licensed by BBE Sound, Inc. under USP 4638258.4482866. BBE and BBE symbol are trademarks of BBE Sound, Inc.

(●)® SRS (SOUND RETRIEVAL SYSTEM) (KV-27FV17 only)

The (●) SRS (SOUND RETRIEVAL SYSTEM) is manufactured by Sony Corporation under license from SRS Labs, Inc. It is covered by U.S. Patent No. 4,748,669. Other U.S. and foreign patents pending.

The word 'SRS' and the SRS symbol (●) are registered trademark of SRS Labs, Inc.

Important Safeguards

For your protection, please read these instructions completely, and keep this manual for future reference. Carefully observe and comply with all warnings, cautions and instructions placed on the set, or described in the operating instructions or service manual.

WARNING

To guard against injury, the following basic safety precautions should be observed in the installation, use, and servicing of the set.

Use

Power Sources

This set should be operated only from the type of power source indicated on the serial/model plate. If you are not sure of the type of electrical power supplied to your home, consult your dealer or local power company. For those sets designed to operate from battery power, refer to the operating instructions.



Grounding or Polarization

This set is equipped with a polarized AC power cord plug (a plug having one blade wider than the other), or with a three-wire grounding type plug (a plug having a third pin for grounding).

Follow the instructions below:

For the set with a polarized AC power cord plug

This plug will fit into the power outlet only one way. This is a safety feature. If you are unable to insert the plug fully into the outlet, try reversing the plug. If the plug should still fail to fit, contact your electrician to have a suitable outlet installed. Do not defeat the safety purpose of the polarized plug by forcing it in.



Alternate Warning

For the set with a three-wire grounding type AC plug

This plug will only fit into a grounding-type power outlet. This is a safety feature. If you are unable to insert the plug into the outlet, contact your electrician to have a suitable outlet installed. Do not defeat the safety purpose of the grounding plug.

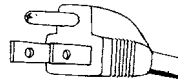

Overloading

Do not overload wall outlets, extension cords or convenience receptacles beyond their capacity, since this can result in fire or electric shock. Always turn the set off when it is not to be used. When the set is left unattended and unused for long periods of time, unplug it from the wall outlet as a precaution against the possibility of an internal malfunction that could create a fire hazard.

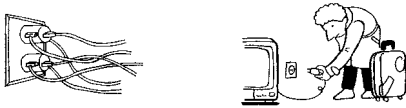

Do not disconnect the antenna or the power cord during a heavy storm. Lightning may strike while you are holding the cable or cord, causing serious injury. Turn off your TV and wait for the weather to improve.

Object and Liquid Entry

Never push objects of any kind into the set through the cabinet slots as they may touch dangerous voltage points or short out parts that could result in a fire or electric shock. Never spill liquid of any kind on the set.



Attachments

Do not use attachments not recommended by the manufacturer, as they may cause hazards.

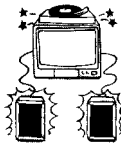

Do not place any objects, especially heavy objects, on top of the set. The object may fall from the set, causing injury.

Cleaning

Unplug the set from the wall outlet before cleaning or polishing it. Do not use liquid cleaners or aerosol cleaners. Use a cloth lightly dampened with water for cleaning the exterior of the set.



If a snapping or popping sound from a TV set is continuous or frequent while the TV is operating, unplug the TV and consult your dealer or service technician. It is normal for some TV sets to make occasional snapping or popping sounds, particularly when being turned on or off.



Installation

Always use two or more people to lift or move the set. The set is heavy and the bottom surface is flat. Serious injury can result from trying to move the set by yourself alone, or from unsteady handling. Install the set on a stable, level surface.

Water and Moisture

Do not use power-line operated sets near water — for example, near a bathtub, washbowl, kitchen sink, or laundry tub, in a wet basement, or near a swimming pool, etc.

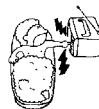

Accessories

Do not place the set on an unstable cart, stand, tripod, bracket, table, or shelf. The set may fall, causing serious injury to a child or an adult, and serious damage to the set. Use only a cart or stand recommended by the manufacturer for the specific model of TV. Any mounting of the product should follow the manufacturer's instructions, and should use a mounting accessory recommended by the manufacturer. An appliance and cart combination should be moved with care. Quick stops, excessive force, and uneven surfaces may cause the appliance and cart combination to overturn.

Disconnect all cables and cords from the set before attempting to move the set.



Do not allow children or pets to climb up onto, or push against, the set. The set may fall, causing serious injury.

Ventilation

The slots and openings in the cabinet and in the back or bottom are provided for necessary ventilation. To ensure reliable operation of the set, and to protect it from overheating, these slots and openings must never be blocked or covered.

- **Never cover the slots and openings with a cloth or other materials.**



- **Never block the slots and openings by placing the set on a bed, sofa, rug or other similar surface.**

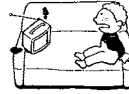

- **Never place the set in a confined space, such as a bookcase, or built-in cabinet, unless proper ventilation is provided.**



- **Do not place the set near or over a radiator or heat register, or where it is exposed to direct sunlight.**



Power-Cord Protection

Do not allow anything to rest on or roll over the power cord, and do not place the set where the power cord is subject to wear or abuse.



Grounding or Polarization

This set may be equipped with a polarized alternating current line plug (a plug having one blade wider than other). This plug will fit into the power outlet only one way. This is a safety feature. If you are unable to insert the plug fully into the outlet, try reversing the plug. If the plug should still fail to fit, contact you electrician to replace your obsolete outlet. Do not defeat the safety purpose of the polarized plug.

Antennas

Outdoor Antenna Grounding

If an outdoor antenna is installed, follow the precautions below. An outdoor antenna system should not be located in the vicinity of overhead power lines or other electric light or power circuits, or where it can come in contact with such power lines or circuits.

WHEN INSTALLING AN OUTDOOR ANTENNA SYSTEM, EXTREME CARE SHOULD BE TAKEN TO KEEP FROM CONTACTING SUCH POWER LINES OR CIRCUITS AS CONTACT WITH THEM IS ALMOST INVARIABLY FATAL.

Be sure the antenna system is grounded so as to provide some protection against voltage surges and built-up static charges. Section 810 of the National Electrical Code (NEC) in USA and Section 54 of the Canadian Electrical Code in Canada provides information with respect to proper grounding of the mast and supporting structure, grounding of the lead-in wire to an antenna discharge unit, size of grounding conductors, location of antenna discharge unit, connection to grounding electrodes, and requirements for the grounding electrode.

Antenna Grounding According to the NEC

Refer to section 54-300 of Canadian Electrical Code for Antenna Grounding.

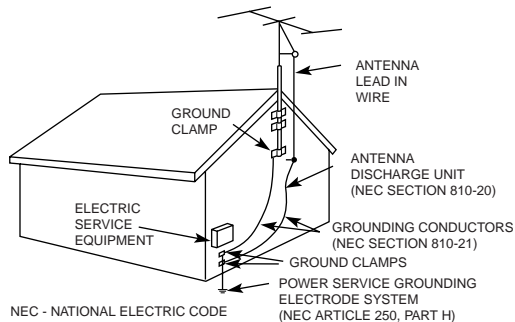

Lightning

For added protection for this television receiver during a lightning storm, or when it is left unattended and unused for long periods of time, unplug it from the wall outlet and disconnect the antenna. This will prevent damage to the receiver due to lightning and power-line surges.

Service

Damage Requiring Service

Unplug the set from the wall outlet and refer servicing to qualified service personnel under the following conditions:

- When the power cord or plug is damaged or frayed.

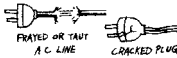

- If liquid has been spilled into the set.

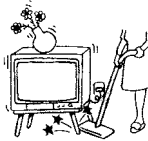

- If the set has been exposed to rain or water.



- If the set has been subject to excessive shock by being dropped, or the cabinet has been damaged.



- If the set does not operate normally when following the operating instructions. Adjust only those controls that are specified in the operating instructions. Improper adjustment of other controls may result in damage and will often require extensive work by a qualified technician to restore the set to normal operation.



- When the set exhibits a distinct change in performance — this indicates a need for service.

Servicing

Do not attempt to service the set yourself since opening the cabinet may expose you to dangerous voltage or other hazards. Refer all servicing to qualified service personnel.

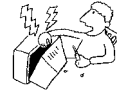

Replacement Parts

When replacement parts are required, be sure the service technician certifies in writing that he has used replacement parts specified by the manufacturer that have the same characteristics as the original parts. Unauthorized substitutions may result in fire, electric shock, or other hazards.



Safety Check

Upon completion of any service or repairs to the set, ask the service technician to perform routine safety checks (as specified by the manufacturer) to determine that the set is in safe operating condition, and to so certify. When the set reaches the end of its useful life, improper disposal could result in a picture tube implosion. Ask a qualified service technician to dispose of the set.



Contents

Introduction

Trinitron® Color TV Features	1
Batteries for the Remote Control.....	2
About this Manual	2







Connecting Your TV

Basic Connections.....	3
Cable Box Connections	4
Connecting Additional Equipment	6

Using the Remote Control and Basic Functions

Using the Remote Control.....	15
Setting Up the TV Automatically	17
Using Picture in Picture (PIP).....	18
Quick Start to the Menus.....	20

Using the Menus

Using the Video  Menu.....	23
Using the Audio  Menu.....	24
Using the Channel Setup  Menu	26
Parental Control.....	28
Using the Parental Control  Menu	31
Using the Timer  Menu	34
Using the Setup  menu	35
Using the Basic  Menu	36

Other Information

Programming the Remote Control	37
Troubleshooting	41
Specifications.....	44

Index	46
--------------------	----

Introduction

Congratulations on your purchase of the Sony Trinitron® Color TV. Before you begin using this manual, please check the model number located on the rear of your TV or on the front cover of this manual.

Trinitron® Color TV Features

Some of the features you will enjoy include:

- ❑ **FLAT CRT** — New technologically advanced screen for optimal picture quality.
- ❑ **Parental Control** — A tool for parents to help monitor what their children watch on TV by establishing rating limits.
- ❑ **Favorite Channel** — Instant access to your favorite channels with the touch of a button.
- ❑ **Picture in Picture (PIP)** — Allows you to view two channels simultaneously (KV-27FV17, KV-27FS17, KV-32FS17 only).
- ❑ **Universal Remote Control** — Program your remote control to operate your connected cable box, VCR, digital satellite receiver, or DVD player.
- ❑ **Energy Star®** — A recognized symbol of energy efficiency.
- ❑ **S VIDEO** — A video input that offers enhanced picture quality.
- ❑ **Direct MTS** — Allows direct access to changing your Multi-Channel TV Sound: Stereo, Mono, or Auto-SAP (Second Audio Program), with the touch of a button.
- ❑ **Trilingual Menus** — Choose between English, French, or Spanish menus.
- ❑ **Front Panel Controls** — Allows for access to the on-screen menus without the use of a remote control.
- ❑ **Front A/V inputs** — A quick connection for video games, camcorders, or stereo/mono equipment.

Batteries for the Remote Control

Insert two AA (R6) batteries (supplied) into the remote control using the following illustration as a guide.

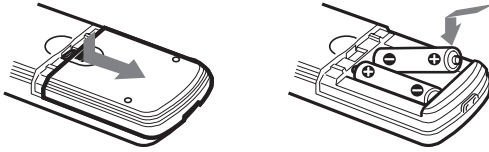

 Under normal conditions, batteries will last up to six months. If the remote control does not operate properly, the batteries might be worn out.

 If you will not be using the remote control for an extended period of time, remove the batteries to avoid possible damage from battery leakage.

 Your remote control can be programmed to operate most video equipment, (see page 37).

About this Manual

This manual provides instructions to help you enjoy your new TV. It shows you how to connect to an antenna or cable, cable box, VCR, DVD, satellite receiver, stereo system or camcorder. Once you are connected, follow the instructions and use the remote control to access the on-screen menus.

 The TV front and rear panels illustrated in this manual are for KV-27FS13, KV-27FS17, KV-32FS13, and KV-32FS17. The rear panel shown on page 13 is for KV-27FV17. Your front and rear panels may not look exactly like those illustrated.

Connecting Your TV

Read this chapter before setting up your TV for the first time. This section covers basic connections in addition to any optional equipment you may be connecting.

Basic Connections

TV with indoor or outdoor antenna, or CATV cable

Depending on the cable available in your home, choose one of the connections below:

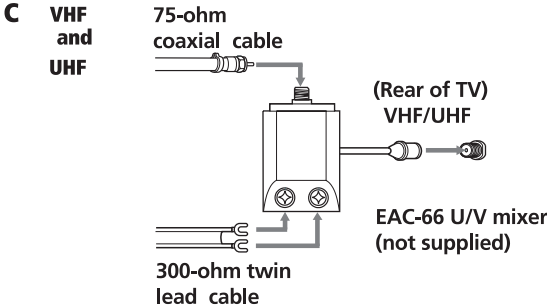
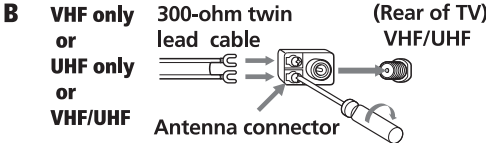
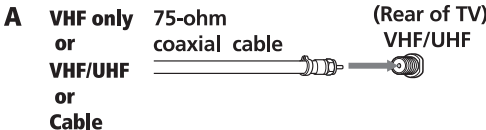

 If you are connecting to an indoor or outdoor antenna, you may need to adjust the orientation of the antenna for best reception.

Cable Box Connections

Some cable TV systems use scrambled or encoded signals that require a cable box to view all channels. If you subscribe to that kind of cable service, use this connection. Scrambled signals coming in to the TV through the cable box cannot be viewed in PIP. If some of your channels are scrambled, consider using the Cable Box and Cable connection (see page 5).

Cable Box and TV

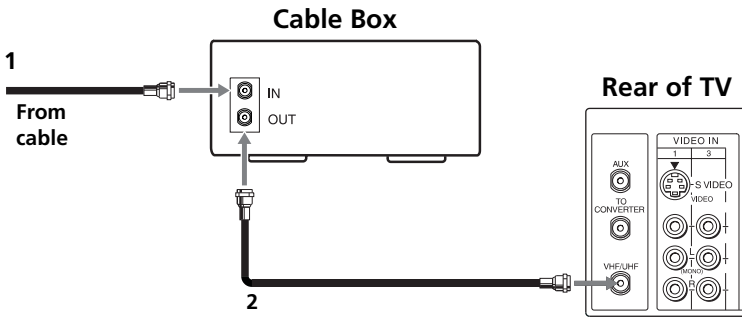

- 1** Connect the coaxial cable from your cable service to the IN jack on your cable box.
- 2** Connect a coaxial cable (not supplied) from the OUT jack on your cable box to the VHF/UHF jack on your TV.

 If you will be controlling all channel selection through your cable box, you should consider using the Channel Fix feature by setting your TV to channel 3 or 4, (see page 27).

Cable Box and Cable



Use this connection if you subscribe to a cable system that scrambles some channels (pay channels), but not all of them. This set up allows you to use the remote control to:

- a) change channels through your cable box when you are receiving a scrambled signal, and
- b) change channels through your TV.

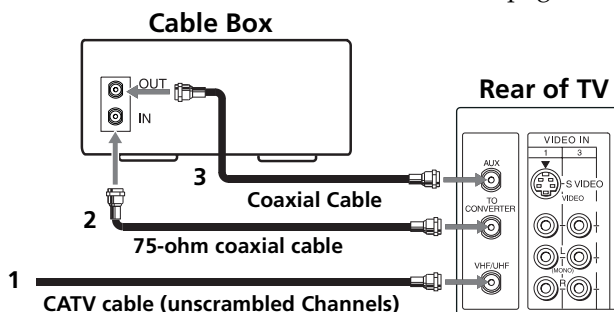
This connection also allows you to use the PIP feature when you are viewing unscrambled channels coming directly into your TV from your cable. Scrambled signals coming through the cable box cannot be viewed in PIP. For more information on the PIP feature, see page 18.



- 1** Connect the coaxial cable from your cable service to the VHF/UHF jack on your TV.
- 2** Using a coaxial cable (not supplied), connect the IN jack on your cable box to the TO CONVERTER jack on your TV.
- 3** Using a coaxial cable (not supplied), connect the OUT jack on your cable box to the AUX jack on your TV.

 Pressing the  button on the remote control switches between the cable box and direct cable inputs.

 Your Sony remote control can be programmed to operate your cable box, (see page 38).

 To use the cable box to change your channels, set your TV to channel 3 or 4. Setting the Channel Fix feature will assure you don't accidentally switch the channels using your TV, (see page 27).

Connecting Additional Equipment

TV and VCR

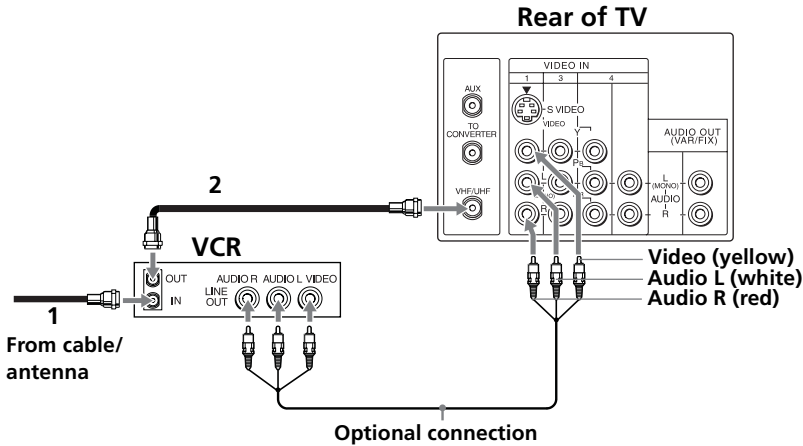

To watch video programs from your VCR, tune your TV to channel 3 or 4 (as set on the rear of your VCR).

- 1** Connect the coaxial cable from your TV antenna or cable service to the IN jack on your VCR.
- 2** Using a coaxial cable (not supplied), connect the OUT jack on your VCR to the VHF/UHF jack on the TV.

Optional connection

If your VCR is equipped with video outputs, you can get better picture quality by connecting Audio/Video cables (not supplied) from AUDIO and VIDEO OUT on your VCR to AUDIO/VIDEO IN on your TV.

For optimum picture quality, use S VIDEO instead of the yellow Audio/ Video cable. S VIDEO does not provide sound; the audio cables must still be connected.

You can use the TV_{VIDEO} button to switch between the VHF/UHF and VIDEO inputs.

TV, VCR, and Cable Box

Use this connection if you subscribe to a cable system that scrambles some channels (pay channels), but not all of them. This set up allows you to use the remote control to:

- a) change channels through your cable box or VCR when you are receiving a scrambled signal, and
- b) change channels through your TV.

This connection also allows you to use the PIP feature when you are viewing unscrambled channels coming directly into your TV from your cable. Scrambled signals coming through the cable box cannot be viewed in PIP. For more information on the PIP feature, see page 18.

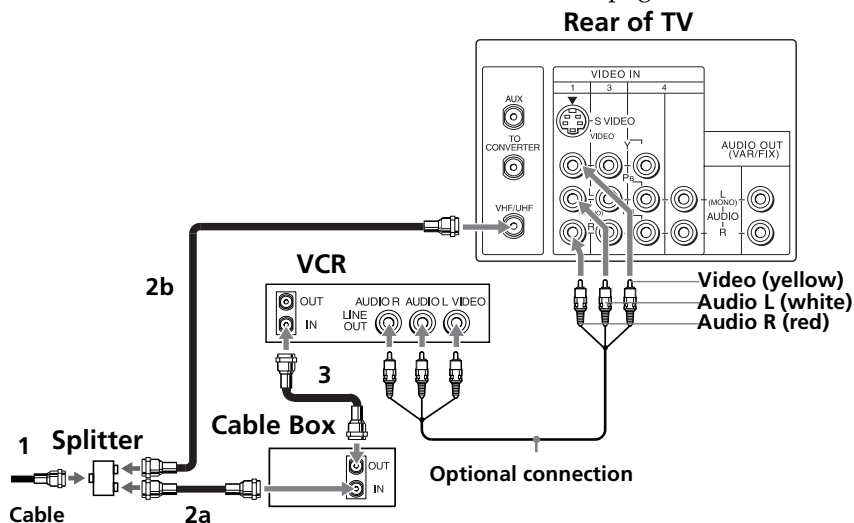



- 1** Connect the single input jack of the splitter to your incoming cable connection.
- 2** Using a coaxial cable (not supplied), connect the two output jacks of the splitter to:
 - a) the IN jack on your cable box, and
 - b) the VHF/UHF jack on the TV.
- 3** Using a coaxial cable (not supplied), connect the OUT jack on your cable box to the IN jack on your VCR.

(continued)

-  If you will be controlling all channel selections through your cable box, you should consider using the Channel Fix feature by setting your TV to channel 3 or 4, (see page 27).

Optional connection

If your VCR is equipped with video outputs, you can get better picture quality by connecting Audio/Video cables (not supplied) from AUDIO and VIDEO OUT on your VCR to AUDIO/VIDEO IN on your TV.

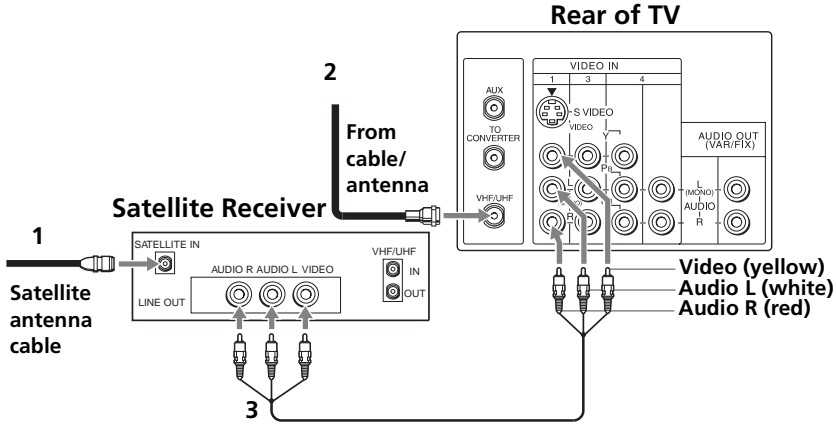

-  For optimum picture quality, use S VIDEO instead of the yellow Audio/ Video cable. S VIDEO does not provide sound; the audio cables must still be connected.
-  You can use the  button to switch between the VHF/UHF and VIDEO inputs.

TV and Satellite Receiver



- 1** Connect the cable from your satellite antenna to SATELLITE IN on your satellite receiver.
- 2** Connect the coaxial cable from your cable or antenna to the VHF/UHF jack on your TV.
- 3** Using Audio/Video cables (not supplied), connect AUDIO and VIDEO OUT on your satellite receiver to AUDIO and VIDEO IN on your TV.

 For optimum picture quality, use S VIDEO instead of the yellow Audio/ Video cable. S VIDEO does not provide sound; the audio cables must still be connected.

 You can use the  button to switch between the VHF/UHF and satellite receiver inputs.

TV, Satellite Receiver, and VCR

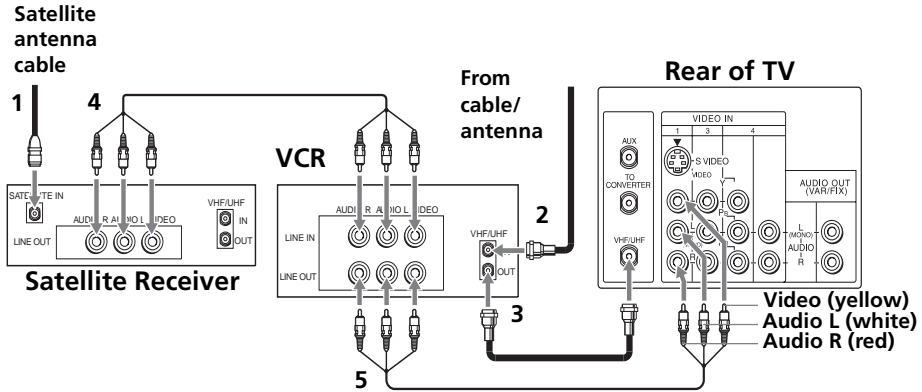



- 1** Connect the cable from your satellite antenna to SATELLITE IN on your satellite receiver.
- 2** Connect the coaxial cable from your cable or antenna to the IN jack on your VCR.
- 3** Using a coaxial cable (not supplied), connect the OUT jack on your VCR to the VHF/UHF jack on your TV.
- 4** Using Audio/Video cables (not supplied), connect AUDIO and VIDEO OUT on your satellite receiver to AUDIO and VIDEO IN on your VCR.
- 5** Using Audio/Video cables (not supplied), connect AUDIO and VIDEO OUT on your VCR to AUDIO and VIDEO IN on your TV.

 To view from the satellite receiver or VCR, select the video input to which your satellite receiver or VCR is connected by pressing TV_{VIDEO} on the remote control.

Connecting a Camcorder

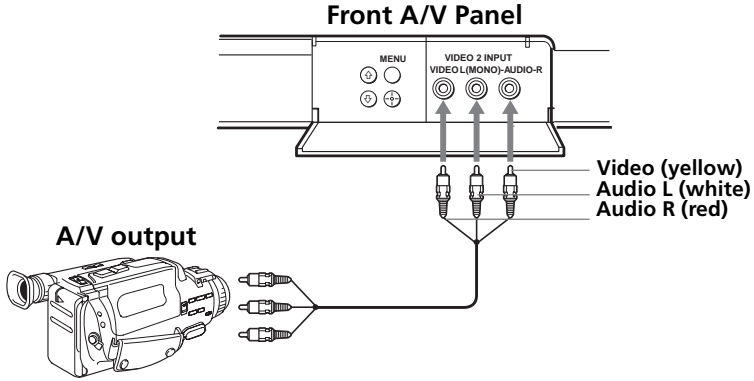
Using Audio/Video cables (not supplied), connect AUDIO and VIDEO OUT on your camcorder to AUDIO and VIDEO IN on your TV.



 If you have an S VIDEO equipped camcorder, you can use an S VIDEO cable for optimum picture quality.

Connecting a DVD Player

Using Audio/Video cables (not supplied), connect AUDIO and VIDEO OUT on your DVD player to AUDIO and VIDEO IN on your TV.

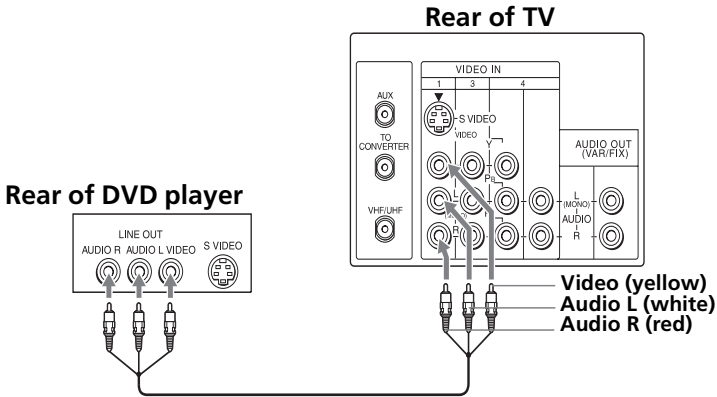

 For optimum picture quality, use S VIDEO instead of the yellow Audio/ Video cable. S VIDEO does not provide sound, the audio cables must still be connected.

Connecting an Audio System

Using Audio cables (not supplied), connect AUDIO OUT on your TV to one of the unused line inputs (e.g. TV, AUX, TAPE2) on your stereo.

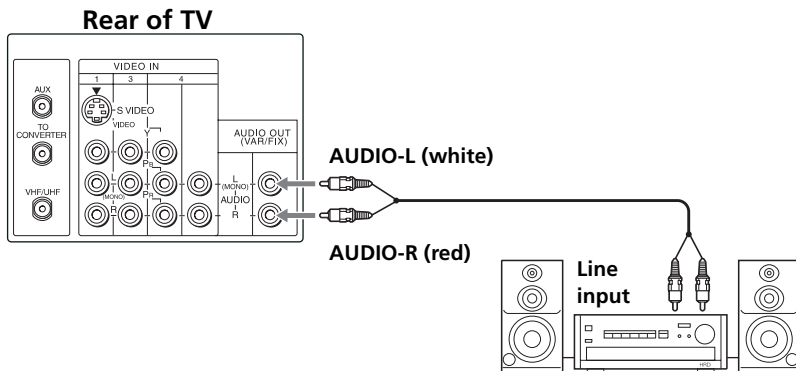

 Set your stereo to the selected line input. See page 24 for additional audio setup instructions.



Connecting Two VCRs for Tape Editing

KV-27FV17 only

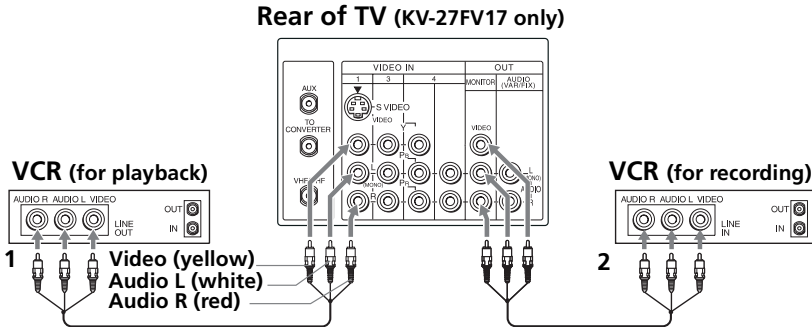
You can connect two VCRs together to edit video tapes. You can also connect both VCRs to your TV to view the program being recorded.



- 1** Using an Audio/Video cable (not supplied), connect AUDIO and VIDEO OUT on your first VCR to AUDIO and VIDEO IN on your TV.
- 2** Using Audio/Video cable (not supplied), connect AUDIO and VIDEO OUT on the second VCR to the MONITOR AUDIO and VIDEO OUT on your TV.



 To perform tape editing, set the TV to the video input intended for playback by pressing .

Using the Remote Control and Basic Functions

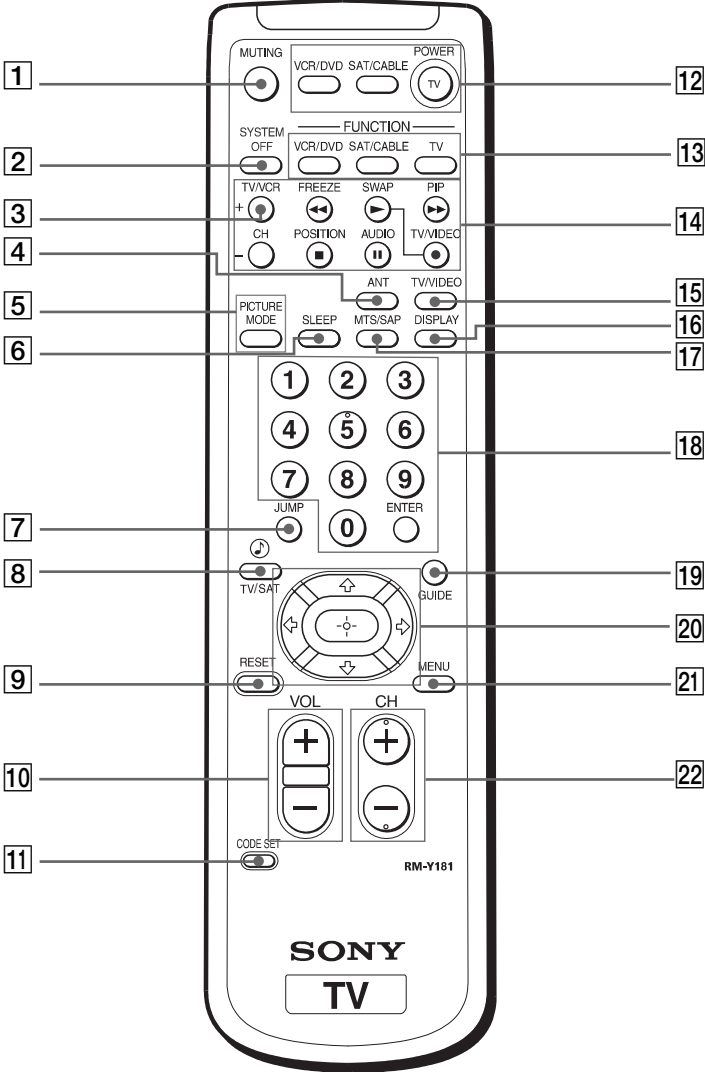
This section shows you how to use the more advanced buttons on the remote control and how to use the on-screen menus.





Using the Remote Control

Button	Description
1 MUTING	Instantly turns off the sound. Press again or press  to restore sound.
2 SYSTEM OFF	Powers off all Sony equipment at once, (may not work with older equipment).
3 TV/VCR	Press when you are finished using a VCR and you want to switch to the TV input. Your VCR power will remain on.
4 ANT (antenna)	Press to change the VHF/UHF input to the AUX input (KV-27FS17, KV-27FV17, KV-32FS17 only).
5 PICTURE MODE	Cycles through the available Video Mode settings.
6 SLEEP	Turns the TV off automatically in approximately 15, 30, 45, 60, 90, or 120 minutes. Cancel by pressing until SLEEP OFF appears.
7 JUMP	Alternates between the last two channels selected with the  .
8 	Cycles through available Steady Sound settings, (see page 24).
9 RESET	Press to return to factory settings while in an on-screen menu.
10 VOL (volume)	Press when you want to adjust the volume.
11 CODE SET	Use to program your remote control to operate connected video equipment, (see page 37).
12 POWER	Press when you want to turn connected equipment on and off.
13 FUNCTION	Press when you want to control connected equipment with your remote control.
14 Picture in Picture (PIP)	Operates PIP feature. To use the PIP feature, see page 18.
15 TV/VIDEO	Cycles through available video inputs.
16 DISPLAY	Press once to show current time, (if set) and channel number. Press again to turn DISPLAY off.

 The remote control shown on page 14 (RM-Y181) is for KV-27FS17, KV-27FV17, and KV-32FS17. Your remote control may not look like the one illustrated.

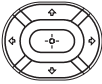
(continued)

17	MTS/SAP	Cycles through the Multi-channel TV Sound (MTS) options: Stereo, Mono, and Auto-SAP (Second Audio Programming).
18	0-9 and ENTER	Change channels directly, and enter numerical values in on-screen displays.
19	GUIDE	Brings up the custom guide of your satellite receiver.
20		Moves the cursor in the on-screen menus. Press the arrow buttons to move the cursor. Press the center button to select or access an option.
21	MENU	Displays the on-screen menu. Press again to exit the menu at any time.
22	CH (channel)	Press when you want to change channels.

 For information on Picture in Picture (PIP) operation buttons, see page 18.



 If you lose your remote control, see page 43.

Setting Up the TV Automatically

After you have finished connecting your TV, you can perform Auto Program to set up your channels.

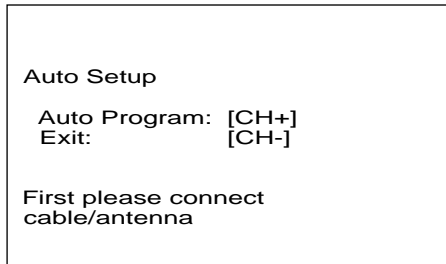









- 1 Press  to turn on the TV. The Initial Setup screen appears.





- 2 Press the TV FUNCTION button.
- 3 Press  on the remote control or in the TV front panel to perform Auto Program, or press  to exit.

 The Initial Setup screen appears each time you turn on the TV until you perform Auto Program.

To perform Auto Program again

- 1 Press .
- 2 Press  to highlight Channel Setup menu ().
- 3 Press  to highlight Cable. Press  to select.
- 4 Press  or  to select ON or OFF according to how you connected your TV. Press .
- 5 Press  to highlight Auto Program. Press  to search for channels.

 After performing Auto Program, press  to exit.

Using Picture in Picture (PIP)

The Picture-in-Picture (PIP) feature allows you to view two channels simultaneously, one in the full size “main” picture and one in a small “window” picture.

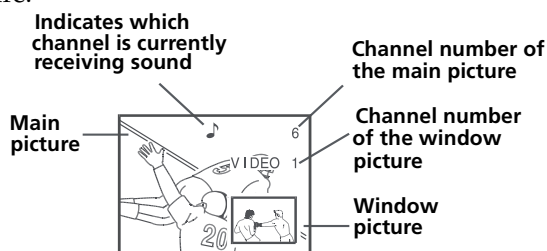



Dual Tuner PIP

KV-27FS17, KV-27FV17, KV-32FS17 only

These models are equipped with dual tuners. This means that PIP is “ready to use.”

	<p>Press to turn the PIP feature on and off. Press repeatedly to change the size of the window picture and to turn off the PIP feature.</p>
	<p>Press repeatedly to cycle through available video inputs on the video equipment you have connected to the TV.</p>
	<p>Press to alternate sound between the main picture and the window picture. The sound symbol  appears for 3 seconds, indicating whether you are hearing the sound from the main or picture window.</p>
	<p>Press to change the channel in the window picture. To change the channel in the main window, use the main CH+/- buttons at the bottom of the remote control.</p>
	<p>Press to move the location of the window picture among the four corners of the screen.</p>
	<p>Press to freeze the window picture. Press again to restore the picture.</p>
	<p>Press to switch the main picture with the window picture. Press again to switch them back.</p>



 The AUX input cannot be viewed in the window picture.

 For more information about your remote control, see page 14.

To use PIP

- 1 Press the TV FUNCTION button on your remote to view a working channel.
- 2 Press the  button and the window picture appears.
- 3 Use the yellow labeled buttons on your remote control to control the PIP features. See page 18 for descriptions on the PIP control buttons.

To check your PIP



- 1 Press the TV FUNCTION button on your remote to view a working channel.
- 2 Press the  button and select that same channel again. You should now have the same program playing in both your main window and your picture window.
- 3 Use the yellow CH+/- to change the channel in the picture window.
- 4 Now use the main CH+/- on the bottom of your remote control to change the channel in the main window.
- 5 Press the  button to switch to other video inputs for other equipment that is connected to any of the VIDEO IN jacks at the back of your TV. You should see a different picture in your PIP window for each connected video equipment component. Make sure the connected equipment is turned on and working when you perform this test.
- 6 If the PIP feature does not work properly with the TV or the connected video equipment component, refer to the Troubleshooting section on pages 41-42 for possible solutions.

 Any video equipment you have connected to the AUX input cannot be viewed in the PIP window.

 If you're viewing all channels through a cable box, the PIP feature will not work. The cable box only unscrambles one signal at a time, so the window picture will be the same as the main picture. However, you can watch a cable channel and another video source. Make sure your DVD, VCR, or satellite receiver is connected to the VIDEO IN jacks on the back of the TV, not the AUX input.

Quick Start to the Menus

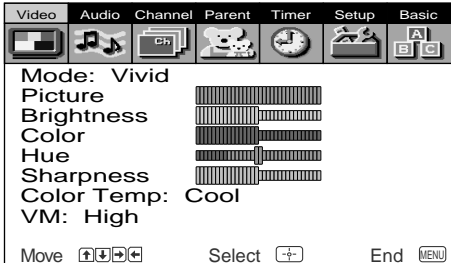
The following settings are available in your on-screen menus:

Menu	Allows you to
 <p>Mode: Vivid Picture Brightness Color Hue Sharpness Color Temp: Cool VM: High</p> <p>Move [Left][Right][Up][Down] Select [Enter] End [MENU]</p>	<p>Make adjustments to your picture settings.</p>
 <p>Treble Bass Balance Steady Sound: OFF Effect: OFF MTS: Stereo Speaker: ON Audio Out: Variable</p> <p>Move [Left][Right][Up][Down] Select [Enter] End [MENU]</p>	<p>Change your audio settings.</p>
 <p>Favorite Channel Cable: ON Channel Fix: OFF Auto Program Channel Skip/Add Channel Label</p> <p>Move [Left][Right][Up][Down] Select [Enter] End [MENU]</p>	<p>Customize your channel settings.</p>

 The menus illustrated in this manual are for KV-27FV17. Your menus may not look like those illustrated.

Menu

Allows you to



Set rating limits on your TV based on a program's rating or content.



Set the clock on your TV and program scheduled viewing using Timer 1 and Timer 2.



Program your channels, label video inputs, select menu languages, or run a demo of the menus.

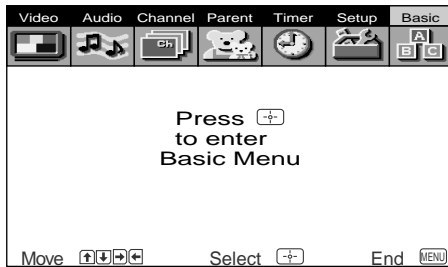









Set basic settings for your TV.

Using the Menu

This section shows the options available for setting up and adjusting your TV.

To access a menu

- 1** Press  to display the on-screen menu.
- 2** Use  or  to highlight the desired menu, then press .
- 3** Use the  or  buttons to highlight the desired option, then press .
- 4** Press  to complete the adjustment.
- 5** Press  to exit the menu.

Using the Video Menu

To access the Video menu, refer to the following steps:

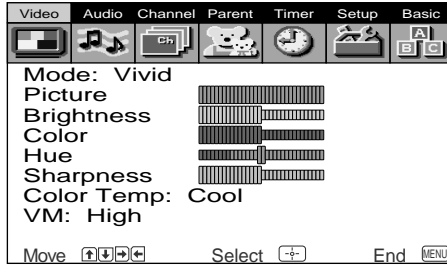

Mode

Customized picture viewing

Vivid: Select for enhanced picture contrast and sharpness.

Standard: Select for a standard picture.

Sports: Select for a bright picture.

Movie: Select for a finely detailed picture.



Press



for direct Mode settings (Vivid, Standard, Sports, Movie).

Picture

Picture contrast

Press ⇐ to decrease picture contrast.

Press ⇒ to increase picture contrast.

Brightness

Picture adjustment

Press ⇐ to darken the picture.

Press ⇒ to brighten the picture.

Color

Color saturation

Press ⇐ to decrease color saturation.

Press ⇒ to increase color saturation.

Hue

Color tones

Press ⇐ to increase the red tones.

Press ⇒ to increase the green tones.

Sharpness

Picture detail

Press ⇐ to soften the picture.

Press ⇒ to sharpen the picture.

Color Temp

White intensity adjustment

Cool: Gives the white colors a blue tint.

Neutral: Gives the white colors a neutral tint.

Warm: Gives the white colors a red tint.

VM

Velocity Modulation



Sharpens picture definition to give objects a sharp, clean edge. Select from one of the following options: **High**, **Low**, **OFF**.

Using the Audio Menu

To access the Audio menu, refer to the following steps:



Treble	Press \leftarrow to decrease the higher pitched sound. Press \rightarrow to increase the higher pitched sound.
Bass	Press \leftarrow to decrease the lower pitched sound. Press \rightarrow to increase the lower pitched sound.
Balance	Press \leftarrow to emphasize the left speaker sound. Press \rightarrow to emphasize the right speaker sound.
Steady Sound <i>Stabilizes volume</i>	KV-27FV17 only Press \uparrow or \downarrow to select one of the following options: ON: Select to stabilize the volume when changing channels. OFF: Select to turn Steady Sound off.

 Press  for a direct selection of Steady Sound settings.

Effect	Press \uparrow or \downarrow to select one of the following options: OFF: Normal stereo or mono reception. SRS: Produces a dynamic three-dimensional sound for stereo audio signals (KV-27FV17 only). Simulated: Add a surround-like effect to mono programs (KV-27FV17 only). Surround: Simulates theater quality sound for stereo programs (KV-27FS13, KV-27FS17, KV-32FS13, KV-32FS17 only).
---------------	---

MTS*Multi-Channel
sound***Stereo:** Select when viewing a broadcast in stereo.**Mono:** Select to reduce noise in areas of poor reception.**Auto-SAP:** Select to have the TV automatically switch to a Second Audio Program (SAP) when a signal is received.

If your TV is set to Auto-SAP, some programs may be muted or distorted. If your TV does not output sound, change your Audio settings to Stereo or Mono.



Press  for direct MTS settings (Stereo, Mono, Auto-SAP).

Speaker*Custom selection
of audio output
source***ON:** Select to listen to the sound from the TV speakers with or without a separate stereo system.**OFF:** Select to turn off the TV speakers and listen to the TV's sound only through external audio system speakers.**Audio Out***Use to control the
TV's volume
through a stereo*

Use Audio Out only when you have an external audio system connected to your TV.

Variable: Adjust the volume through your TV.**Fixed:** Adjust the TV volume through a connected stereo.

Audio Out can only be set when Speaker is set to OFF.

Using the Channel Setup Menu

To access the Channel Setup menu, refer to the following steps:



Favorite Channel

Quick access to favorite channels

With the Favorite Channel menu open:

- 1 Press to select.
- 2 Use the or buttons to select Auto or Manual. When Auto is selected, the last seven channels accessed by the will appear.
- 3 When in Manual, press then to select the position (1-7) where you want to set a favorite channel. Then press .
- 4 Using the or buttons, select the desired channel.
- 5 Press to change to the channel entered. Press to exit.

To use Favorite Channel: Exit all menus and press . Press or to move the cursor to the desired channel number and press .

After you close the menu, the PIP window picture appears so you can preview the favorite channel (KV-27FS17, KV-27FV17, KV-32FS17 only).

Cable

ON: Select if you are receiving cable channels with a CATV cable.

OFF: Select if you are using a TV antenna.

After changing your cable settings, you will need to perform Auto Program.

Channel Fix	<p>2-6: Select when you want to control all channel selection through a cable box or VCR. Select the appropriate channel (usually 3 or 4) and use the cable box's or VCR's remote control for channel selection.</p> <p>Video 1: Select from available video inputs when you have connected video equipment (e.g. satellite receiver) and you want your TV fixed to it.</p> <p>AUX 2-6: Use this setting instead of the 2-6 if you want to change channels using a cable box, VCR or satellite receiver and you've connected it to the AUX input.</p>
Auto Program	<p>Perform Auto Program whenever setting up your TV. It will cycle through all available channels and program any receivable channels.</p>
Channel Skip/Add	<p>Use this feature after you run Auto Program to skip unwanted channels or add new ones.</p> <ol style="list-style-type: none"> 1 Use the 0-9 buttons or the [CH+/-] buttons to select the channel. 2 Press + to Skip or Add (only one option will be available).
<p>Channel Label <i>Label up to 40 channels with their call letters</i></p>	<p>With the Channel Label window open:</p> <ol style="list-style-type: none"> 1 Press +, then press ↑ or ↓ until you reach the desired channel number. 2 Press + to activate the channel. 3 Press ↓ then press + to highlight the label field. 4 Press ↑ or ↓ to display the first call letter or number of the caption and press + to select it. When finished, press + to activate.

 Favorite Channel, Channel Skip/Add, and Channel Label cannot be used when Channel Fix is set.

Movie Ratings

(U.S. models only)

This system defines the rating levels of movies shown in theaters and on prime cable channels.

Rating	Defined as
G	General audience
PG	Parental Guidance suggested
PG-13	Parents strongly cautioned
R	Restricted
NC-17	No one 17 and under admitted
X	Adult audience only

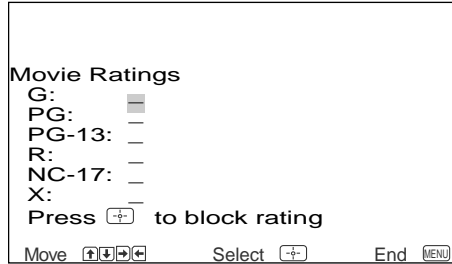

Unrated

(U.S. models only)

You have the option of blocking TV programs or movies that are not rated.

Allow	Allows all unrated programs
Block	Blocks all unrated programming



If you choose to block unrated TV programs, please be aware that the following programs may be blocked: emergency broadcasts, political programs, sports, news, public service announcements, religious programs, and weather.

English Ratings

(Canadian models only)

These ratings are for Canadian programs that are broadcast in English.

Rating	Defined as
C	Children
C8+	Children 8 years and older
G	General programming
PG	Parental Guidance
14+	Viewers 14 and older
18+	Adult programming

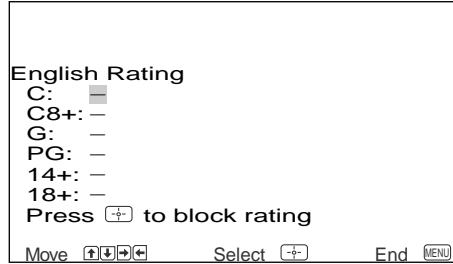

French Ratings

(Canadian models only)

These ratings are for Canadian programs that are broadcast in French.

Rating	Defined as
G	General
8 ans+	Not recommended for younger children
13 ans+	Not recommended for children under age 13
16 ans+	Not recommended for ages under 16
18 ans+	This program is restricted to adults

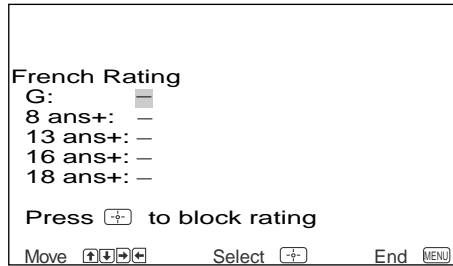

U.S.A. Ratings

(Canadian models only)

For programs from the United States, see “TV Ratings” on page 28.

Using the Parental Control Menu

To access the Parental Control menu, refer to the following steps:

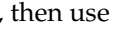

In the Parental Control  menu, you will be asked to set a 4-digit password for any further access into Parental Control.

- 1 Press , then use the  to enter a 4-digit password.

 Keep this instruction manual in a safe place. If you forget your password, see page 42.

- 2 Confirm your password by entering it again.

Once your password is set correctly, the next Parental Control menu appears.

Setting the rating

You can change the Rating by selecting one of the Parental Lock options.

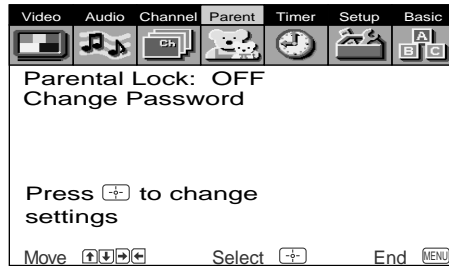

- 1 Move the cursor to Parental Lock and press [right arrow].

If you are not familiar with the Parental Guidelines rating system, use one of the following preselected categories to simplify the rating selections: Child, Youth, or Young Adult.

- 2 Use the [up] or [down] buttons to select the desired rating, and press [right arrow].

Rating	TV will allow a maximum rating of:
Child	TV-Y, TV-G, G (U.S. models only), G (Canadian models only)
Youth	TV-PG, PG (U.S. models only), PG (Canadian models only)
Young Adult	TV-14, PG-13 (U.S. models only), 14+ (Canadian models only)
Custom	Select to set more restrictive ratings, (see next section)
OFF	No rating limit

Using the Custom menu

Before setting Custom ratings, see pages 28-30, “Overview of the Ratings,” for a description of the available rating systems.

Follow the instructions on the screen to make your custom settings. See page 29 for U.S. models and page 30 for Canadian models for more information.

 Once you have blocked a rating or content, all higher ratings or content will be automatically blocked.

Changing your password

- 1 Use the \uparrow or \downarrow buttons to move the cursor to Change Password and press ENTER .
- 2 Follow steps 1 and 2 of “Using the Parental Control Menu” on page 31.

Information for Parents

To view a program that exceeds the TV rating

- Press ENTER , then use the 0 - 9 buttons to enter your password.

 Entering your password to view a blocked program will temporarily turn Lock to OFF. To reactivate your Lock settings, turn the TV off then back on. The TV will return to the settings that you have selected.

Using the Timer Menu

To access the Timer menu, refer to the following steps:



- Current Time**
- With the menu open:
- 1 Press **Up** or **Down** to select the current time, then press **[+]**. (If you are in Daylight Saving time, be sure to set Daylight Saving to "ON").
 - 2 Press **Up** or **Down** to enter the current time, then press **[+]**.
 - 3 Press **MENU** to exit the menu.

- Timer 1 and Timer 2 Scheduled viewing**
- With the menu open, set cursor on Timer 1 or Timer 2:
- 1 Press **Up** or **Down** to select Timer 1 or Timer 2, then press **[+]**.
 - 2 Press **Up** or **Down** to enter your time and channel of preference, then press **[+]**.
 - 3 Press **MENU** to exit the menu.

 You must set the Current Time before you can use Timer 1 and Timer 2.

 You can set the Timer to ON, OFF, or Set. Once the timer is set, you can turn it on or off without having to go through the settings.

- Daylight Saving**
- OFF:** Select in fall at the end of Daylight Saving.
ON: Select in spring to compensate for Daylight Saving.

 When you perform Auto Program, all Timer 1 and Timer 2 settings will be cleared.

 Any loss of power will cause Current Time, Timer 1, and Timer 2 settings to be cleared.

Using the Setup Menu

To access the Setup menu, refer to the following steps:





<p>Caption Vision <i>Closed-Captioning</i></p>	<p>Allows you to select from three closed caption modes (for programs that are broadcast with closed caption). Press \uparrow or \downarrow to select one of the following options: OFF: Turns off Caption Vision. CC1, 2, 3, 4: Displays printed dialogue and sound effects of a program. TXT1, 2, 3, 4: Displays network/station information. XDS (Extended Data Services): Displays information about the network and current program, if available.</p>
<p>Video Label <i>Label connected equipment</i></p>	<p>Allows you to label the audio/video equipment you have connected to the TV so you can identify them when in the Display mode. With the Video Label window open: 1 Press \uparrow or \downarrow to access the input you want to label and press \ominus. 2 Press \uparrow or \downarrow to choose a label and press \oplus.</p>
<p>Tilt Correction</p>	<p>Press \downarrow or \uparrow to correct any tilt of the picture by -5 and $+5$. Press \oplus to activate.</p>
<p>Language</p>	<p>Select to display all menus in your language of choice. Use the \uparrow or \downarrow buttons, select the desired language and press \oplus.</p>
<p>16:9 Enhanced</p>	<p>Provides enhanced picture resolution for wide screen sources such as DVD, (only available when the TV is in Video mode).</p>
<p>Demo</p>	<p>Select to perform a demonstration of the on-screen menus.</p>

Using the Basic Menu

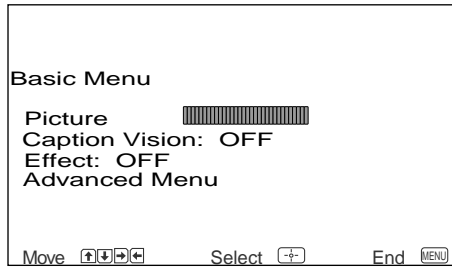
To access the Basic menu, refer to the following steps:









Picture	Press ⇐ to decrease picture contrast.
<i>Picture contrast</i>	Press ⇒ to increase picture contrast.
Caption Vision	Allows you to select from three closed caption modes (for programs that are broadcast with closed caption). Press ⇕ or ⇓ to select one of the following options: OFF: Caption Vision is not activated. CC1, 2, 3, 4: Displays printed dialogue and sound effects of a program. TXT1, 2, 3, 4: Displays network/station information. XDS (Extended Data Services): Displays information about the network and current program, if available.
<i>Closed-Captioning</i>	
Effect	Press ⇕ or ⇓ to select one of the following options: OFF: Normal stereo or mono reception. SRS: Produces a dynamic three-dimensional sound for stereo audio signals (KV-27FV17 only). Simulated: Add a surround-like effect to mono programs (KV-27FV17 only). Surround: Simulates theater quality sound for stereo programs (KV-27FS13, KV-27FS17, KV-32FS13, KV-32FS17 only).
Advanced Menu	Select to return to the main menus.

 If you use the  button to close the Basic menu, only the Basic menu appears when you press  again. To have access to the other menus, use ⇓ to select Advanced Menu.

Other Information

Programming the Remote Control

You can use the supplied remote control to operate Sony or non-Sony video equipment.

- 1 Press .
- 2 Press  or  (FUNCTION).
- 3 Use the - buttons to key in the code number from the following chart.
- 4 Press .

VCR codes

Sony	301, 302, 303	JCPenney	309, 305, 304, 330, 314, 336, 337
Admiral (M.Ward)	327	JVC	314, 336, 337, 345, 346, 347
Aiwa	338, 344	Kenwood	314, 336, 332, 337
Audio Dynamic	314, 337	LXI (Sears)	332, 305, 330, 335, 338
Broksonic	319, 317	Magnavox	308, 309, 310
Canon	309, 308	Marantz	314, 336, 337
Citizen	332	Marta	332
Craig	302, 332	Memorex	309, 335
Criterion	315	Minolta	305, 304
Curtis Mathis	304, 338, 309	Mitsubishi/MGA	323, 324, 325, 326
Daewoo	341, 312, 309	Multitech	325, 338, 321
DBX	314, 336, 337	NEC	314, 336, 337
Dimensia	304	Olympic	309, 308
Emerson	319, 320, 316, 317, 318, 341	Optimus	327
Fisher	330, 335	Panasonic	308, 309, 306, 307
Funai	338	Pentax	305, 304
General Electric	329, 304, 309	Philco	308, 309
Go Video	322, 339, 340	Philips	308, 309, 310
Goldstar	332	Pioneer	308
Hitachi	306, 304, 305, 338	Quasar	308, 309, 306
Instant Replay	309, 308	RCA/PROSCAN	304, 305, 308, 309, 311, 312, 313, 310, 329

VCR codes

Realistic	309, 330, 328, 335, 324, 338
Samsung	322, 313, 321
Sansui	314
Sanyo	330, 335
Scott	312, 313, 321, 335, 323, 324, 325, 326
Sharp	327, 328
Shintom	315
Signature 2000 (M. Ward)	338, 327
SV2000	338
Sylvania	308, 309, 338, 310

Cable box codes

Sony	230
Hamlin/Regal	222, 223, 224, 225, 226
Jerrold/G. I.	201, 202, 203, 204, 205, 206, 207, 208, 218
Oak	227, 228, 229
Panasonic	219, 220, 221
Pioneer	214, 215
Scientific Atlanta	209, 210, 211
Tocom	216, 217
Zenith	212, 213

Laser Disc Player codes

Sony	701
Panasonic	704, 710
Pioneer	702

DBS codes

DIRECTV	809
Echostar/Dish Network	810

Symphonic	338
Tashiro	332
Tatung	314, 336, 337
Teac	314, 336, 338, 337
Technics	309, 308
Toshiba	312, 311
Wards	327, 328, 335, 331, 332
Yamaha	314, 330, 336, 337
Zenith	331

Satellite receiver codes

Sony	801 (preset code for remote control)
General Electric	802
Hitachi	805
Hughes	804
Panasonic	803
RCA/PROSCAN	802, 808
Toshiba	806, 807

DVD codes









Sony	751
JVC	756
Mitsubishi	761
Onkyo	762
Oritron	759
Panasonic	753
Philips/Magnavox	757
Pioneer	752
RCA	755
Samsung/Hitachi	758
Toshiba	754
Zenith	760

 If more than one code number is listed, try entering them one by one until you come to the correct code for your equipment.









 Whenever you remove the batteries the code numbers may revert to the factory setting and must be reset.

 In some rare cases, you may not be able to operate your equipment with the supplied remote control. In this case, use the equipment's supplied remote control.



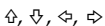

Operating a VCR

Press	To
	Power on the VCR
	Select channels directly
	Change channels
	Play video tape
	Stop
	Search forward or backward
	Pause
	Record
at the same time	
	Change between VCR and TV inputs

Operating a DVD

Press	To
	Power on the DVD
	Select chapters directly
	Search chapters forward or backward
	Play DVD
	Stop
	Pause
	Move the cursor in the menu
	Display the DVD menu



Operating a Laser Disc

Press	To
VTR/DVD 	Power on the laser disc
CH ⊕ ⊖	Search chapters forward or backward
	Play disc
	Stop
	Pause

Troubleshooting

If you are having a problem with your TV, try the suggestions below. If the problem persists, contact your nearest Sony dealer.











No picture, no sound	<ul style="list-style-type: none"> <input type="checkbox"/> Make sure the power cord is plugged in. <input type="checkbox"/> If red light is flashing on the front of your TV for more than a few minutes, disconnect and reconnect the power cord to restore the TV. If the problem continues, call your local service center. <input type="checkbox"/> Check the TV/VIDEO settings: when watching TV, set to TV; when watching video equipment, set to VIDEO (page 15). <input type="checkbox"/> Make sure the batteries have been inserted correctly into the remote control (page 2). <input type="checkbox"/> Try another channel, it could be station trouble.
Poor or no picture, good sound	<ul style="list-style-type: none"> <input type="checkbox"/> Adjust Picture in the Video menu (page 23). <input type="checkbox"/> Adjust Brightness in the Video menu (page 23). <input type="checkbox"/> Check the antenna and/or cable connections (page 3).
Good picture, no sound	<ul style="list-style-type: none"> <input type="checkbox"/> Press  so that MUTING disappears from the screen (page 15). <input type="checkbox"/> Check your Audio settings. Your TV may be set to Auto-SAP (page 25).
No color	<ul style="list-style-type: none"> <input type="checkbox"/> Adjust Color in the Video menu (page 23).
No signal	<ul style="list-style-type: none"> <input type="checkbox"/> Check the Cable setting in the Channel Setup menu (page 26). <input type="checkbox"/> Check the antenna and/or cable connections (page 3). <input type="checkbox"/> Make sure the channel selected is currently broadcasting.
Dotted lines or stripes	<ul style="list-style-type: none"> <input type="checkbox"/> Adjust the antenna. <input type="checkbox"/> Move the TV away from other electronic equipment. Some electronic equipment can create electrical noise, which can interfere with TV reception.
Double images or ghosts	<ul style="list-style-type: none"> <input type="checkbox"/> Check your outdoor antenna or call your cable service provider.
Cannot receive higher number channels (UHF) when using an antenna	<ul style="list-style-type: none"> <input type="checkbox"/> Make sure Cable is set to OFF in the Channel Setup menu (page 26). <input type="checkbox"/> Perform Auto Program to add channels that are not presently in the memory (page 17).

Cable stations don't seem to work	<ul style="list-style-type: none"><input type="checkbox"/> Make sure Cable is set to ON in the Channel Setup menu (page 26).<input type="checkbox"/> Perform Auto Program to add channels that are not presently in the memory (page 17).
Remote control does not operate	<ul style="list-style-type: none"><input type="checkbox"/> Batteries could be weak. Replace them (page 2).<input type="checkbox"/> Move the TV 3-4 feet away from fluorescent lights.
Cannot change channels with the remote control	<ul style="list-style-type: none"><input type="checkbox"/> Make sure you have not inadvertently switched your TV from the channel 3 or 4 setting if you are using another device to change channels.<input type="checkbox"/> If you are using another device to control channels, be sure the FUNCTION button for that device has been pressed. For example, if you're using your VCR to control channels, be sure to press the VTR/DVD FUNCTION buttons (page 15).
The TV needs to be cleaned	<ul style="list-style-type: none"><input type="checkbox"/> Clean the TV with a soft dry cloth. Never use strong solvents such as thinner or benzine, which might damage the finish of the cabinet.
Lost password for Parental Control	<ul style="list-style-type: none"><input type="checkbox"/> In the password screen, enter the following master password: 4357. After using the master password, you must create a new password; it cannot be used to unlock currently blocked channels.
Cannot access other menus when using the Basic Menu	<ul style="list-style-type: none"><input type="checkbox"/> If you use the  button to close the Basic menu, only the Basic menu appears when you press  again. To have access to the other menus, use the  button to select Advanced Menu (page 36).
The remote control won't work in PIP mode	<ul style="list-style-type: none"><input type="checkbox"/> Press the TV FUNCTION button. You may have inadvertently pressed the VTR/DVD FUNCTION button, which changes the PIP buttons to VCR mode (page 15).
There is no window picture or it is just static	<ul style="list-style-type: none"><input type="checkbox"/> Be sure your window picture is set to a video source/channel that has a program airing.<input type="checkbox"/> You may be tuned to a video input with nothing connected to it. Try cycling through your video inputs using the yellow PIP TV/VIDEO button with the red dot (page 18).<input type="checkbox"/> PIP is not set to receive a signal from the AUX input. If you have connected a VCR, DVD or Satellite Receiver to the AUX input on the TV, it will not show in the small window picture.

I get the same program in the window picture as in the main picture

- ❑ Both may be set to the same channel. Try changing channels in either the main picture or the window picture (pages 18-19).
 - ❑ Your TV may be set up to select all your channels through a cable box. The cable box will only unscramble one signal at a time, so you cannot use the PIP feature. If possible, run a direct cable to the VHF/UHF jack on your TV. This will only work if your cable system provides an unscrambled signal (page 5).
-

You lost your remote control

- ❑ You can use the front Audio/Video panel controls to access the menu. Press  to open the menu. Use the  or  buttons on the front Audio/Video panel instead of the  or  buttons on the remote control. Use the  button on the front Audio/Video panel instead of the , , and  buttons on the remote control. Press  again when the setting or adjustment is complete. Contact your nearest Sony dealer to order a replacement.
-

If, after reading these Operating Instructions, you have additional questions related to the use of your Sony television, please call our Direct Response Center at 1-800-222-SONY (7669) (U.S. residents only) or (416) 499-SONY (7669) (Canadian residents only).

Specifications

For all models (except as noted)

Television system	American TV standard/NTSC
Channel coverage	VHF: 2-13/UHF: 14-69/CATV: 1-125
Antenna	75-ohm external antenna terminal for VHF/UHF
Picture tube	FD Trinitron® tube
Power requirements	120V, 60 Hz
Supplied Accessories	Size AA (R6) batteries (2) Remote Control RM-Y180 (1) (KV-27FS13, KV-32FS13) RM-Y181 (1) (KV-27FS17, KV-27FV17, KV-32FS17)
Optional Accessories	Connecting cables VMC-810S/820S, VMC-720M, YC-YC-15V/30V, RK74A U/V mixer EAC-66 TV Stand: SU-27FD4 (27 inch models) SU-32FD4 (32 inch models)
KV-27FS13, KV-27FS17	
Screen size	Visible screen size: 27 inches (679 mm) measured diagonally Actual tube size: 29 inches (736 mm) measured diagonally
Inputs/outputs	3 video, 3 audio 1 S VIDEO 1 AUDIO OUT 1 RF input (KV-27FS13) 2 RF inputs (KV-27FS17)) 1 Y, P _B , P _R , 1 audio
Speaker output	7.5 W x 2
Power Consumption	170 W in use (KV-27FS13) 180 W in use (KV-27FS17) 1 W in standby
Dimensions (W/H/D)	700 x 632 x 512 mm (27 ⁵ / ₈ x 25 x 20 ¹ / ₄ in.)
Mass	47 kg (103 lbs. 10 oz.)

KV-27FV17

Screen size	Visible screen size: 27 inches (679 mm) measured diagonally Actual tube size: 29 inches (736 mm) measured diagonally
-------------	---

Inputs/outputs	3 video, 3 audio 2 S VIDEO 1 Audio Out 1 Monitor Out 2 RF inputs 1 Y, P _B , P _R , 1 audio
----------------	--

Speaker output	15 W x 2
----------------	----------

Power Consumption	220 W in use 1 W in standby
-------------------	--------------------------------

Dimensions (W/H/D)	762 x 604 x 519 mm (30 x 23 ⁷ / ₈ x 20 ¹ / ₂ in.)
--------------------	---

Mass	49 kg (108 lbs.)
------	------------------

KV-32FS13, KV-32FS17

Screen size	Visible screen size: 32 inches (803 mm) measured diagonally Actual tube size: 34 inches (863 mm) measured diagonally
-------------	---

Inputs/outputs	3 video, 3 audio 1 S VIDEO 1 Audio Out 1 RF input (KV-32FS13) 2 RF inputs (KV-32FS17) 1 Y, P _B , P _R , 1 audio
----------------	---

Speaker output	10 W x 2
----------------	----------

Power Consumption	195 W in use (KV-32FS13) 205 W (KV-32FS17) 1 W in standby
-------------------	---

Dimensions (W/H/D)	800 x 708 x 582 mm (31 ¹ / ₂ x 27 ⁷ / ₈ x 23 in.)
--------------------	---

Mass	75 kg (163 lbs.)
------	------------------

Design and specifications are subject to change without notice.

Index

16:9 Enhanced 35

A

Advanced Menu 36
Audio  Menu 24
Audio Out 25
Auto Program 17, 27
Auto-SAP 25

B

Balance 24
Basic  Menu 36
Bass 24
Battery Installation 2
Brightness 23

C

Cable 26
Caption Vision 35, 36
Channel Label 27
Channel Fix 27
Channel Setup  Menu 26
Channel Skip/Add 27
Color 23
Color Temp 23
Connections
 Cable and antenna 3
 Cable Box and Cable 5
 Cable Box and TV 4
 Connecting a Camcorder 11
 Connecting a DVD Player 11
 Connecting an Audio System 12
 Connecting Two VCRs for Tape Editing 13
 TV and VCR 6
 TV and Satellite Receiver 9
 TV, Satellite Receiver, and VCR 10
 TV, VCR, and Cable Box 7
Current Time 34

D

Daylight Saving 34
Demo 35
DISPLAY 15

E

Effect 24, 36
 OFF 24, 36
 Simulated 24, 36
 SRS 24, 36
 Surround 24, 36

F

Favorite Channel 26







H

Hue 23

L

Language 35

M

Menus
 Audio  24
 Basic  36
 Channel Setup  26
 Parental Control  31
 Setup  35
 Timer  34
 Video  23
Mode 23
 Vivid 23
 Standard 23
 Sports 23
 Movie 23
Mono 25
MTS 25
 Auto-SAP 25
 Mono 25
 Stereo 25

O

Overview of the Ratings 28

P

- Parental Control 28
- Parental Control  Menu 31
- Picture 23
- Picture in Picture (PIP) 18
- Programming the Remote Control 37

R

- Remote Control 14
- Ratings
 - English Ratings 30
 - French Ratings 30
 - Movie Ratings 29
 - TV Ratings 28
 - Unrated 29
 - U.S.A. Ratings 30

S

- Setup  Menu 35
- Sharpness 23
- SLEEP 15
- Speaker 25
- Specifications 44
- Steady Sound 24
- Stereo 25

T

- Timer  Menu 34
- Timer 1 and Timer 2 34
- Treble 24
- Troubleshooting 41
- TV Features 1
- Tilt Correction 35

V

- Video  Menu 23
- Video Label 35
- VM 23



FD Trinitron
WEGA

Televisor Trinitron® A Color

Manual de Instrucciones

Lea este manual antes de operar el producto.

KV-29FS13
KV-29FS13C
KV-29FV17
KV-29FV17C

ADVERTENCIA

Para evitar el riesgo de incendio o descarga eléctrica, no exponga el televisor a la lluvia o humedad.



Este símbolo señala al usuario la presencia de voltaje peligroso sin aislamiento en el interior del aparato, y de tal intensidad que podría presentar riesgo de descarga eléctrica.



Este símbolo indica al usuario que el manual que acompaña a este aparato contiene instrucciones importantes referentes a su funcionamiento y mantenimiento.

Nota para el técnico que instale el sistema CATV

El Artículo 820-40 del NEC contiene normas para la puesta a tierra y, en particular, dispone que la tierra del cable debe conectarse al sistema de tierra del edificio en el punto más próximo que sea factible a la entrada del cable.

PRECAUCIONES DE SEGURIDAD

- Alimente el televisor sólo con ca 120 V para los modelos KV-29FS13 y KV-29FV17, y con ca 220 V para los modelos KV-29FS13C y KV-29FV17C.
- La clavija está diseñada, por motivos de seguridad, para entrar a la tomacorriente en una sola posición. Si Ud. no puede meter la clavija completamente a la tomacorriente, consulte con su proveedor.
- Si algún líquido u objeto cae dentro del televisor, desconéctelo inmediatamente y llévelo al personal de servicio técnico especializado para que lo revisen antes de volver a utilizarlo.

PRECAUCIÓN

Al usar videojuegos, computadoras y productos similares con el televisor, mantenga los ajustes de brillo y contraste a un nivel moderado. Si una imagen inmóvil permanece en la pantalla durante un periodo prolongado con elevada intensidad de brillo o contraste, la imagen podría quedar grabada en la pantalla en forma permanente. Igualmente, ver continuamente el mismo canal de televisión podría dejar grabada en la pantalla el logotipo de la emisora. La garantía no cubre este tipo de anomalías, ya que se deben al mal uso del aparato.



Para evitar el riesgo de descarga eléctrica, no emplee esta clavija polarizada con un cable prolongador, receptáculo u otra tomacorriente, a menos que las cuchillas puedan insertarse completamente a fin de que no queden al descubierto.



Cualquier cambio o modificación que no se detalla expresamente en el presente manual podría invalidar su autorización para emplear este aparato.

NOTIFICACIÓN

Este aparato ha sido debidamente probado, comprobándose que cumple con los límites impuestos a dispositivos digitales Clase B de acuerdo con la Sección 15 de las normas de la FCC. Estos límites se establecieron para ofrecer protección razonable contra interferencias perjudiciales en las instalaciones residenciales. Este aparato genera, usa y puede emitir energía radioeléctrica. De no instalarse y utilizarse de acuerdo con las instrucciones correspondientes podría producir interferencias perjudiciales en las radiocomunicaciones. No obstante, no puede garantizarse que no se produzcan estas interferencias en una instalación determinada. Si este aparato llega a interferir en la recepción por radio o televisión, lo que podrá comprobarse encendiendo y apagando el aparato, se recomienda al usuario intentar corregir la interferencia mediante una o más de las siguientes medidas:

- Reoriente o cambie de lugar las antenas receptoras.
- Aumente la distancia que separa este aparato y el receptor afectado.
- Enchufe el aparato en una toma de corriente de un circuito distinto al que esté enchufado el receptor afectado.
- Consulte con el distribuidor o solicite los servicios de un técnico capacitado en radio y televisión.

Protección del televisor

- Para evitar el sobrecalentamiento interno, no tape las rejillas de ventilación.
- No instale el televisor en un lugar caliente o húmedo, ni donde quede expuesto a cantidades excesivas de polvo o vibraciones mecánicas.

Nota sobre la función "Caption Vision"

Este televisor permite ver subtítulos, en cumplimiento con lo dispuesto en el inciso 15,119 de las normas de la Comisión Federal de Comunicaciones (FCC) de EE.UU.

El empleo de este televisor para fines que no sean la recepción privada de programas transmitidos por UHF, VHF o cable, destinados al uso del público en general, podría requerir autorización de la emisora o compañía de cable del propietario del programa o de ambos.

Registro de propiedad

El modelo y el número de serie están situados en la portada de este manual y en la parte posterior del televisor.

Marcas comerciales y copyrights

ENERGY STAR® es marca registrada.



Como socio de ENERGY STAR®, Sony ha determinado que este producto o este modelo de producto cumple con las pautas ENERGY STAR® para eficiencia energética.

Sólo para los modelos KV-29FV17 y KV-29FV17C

Bajo licencia de BBE Sound, Inc sobre el número USP 4638258.4482866. BBE y símbolo de BBE son marcas registradas de BBE Sound, Inc.

Normas de seguridad importantes

Para su protección, lea detenidamente estas instrucciones, y guarde este manual para futuras referencias. Lea cuidadosamente todas las advertencias y precauciones, y siga las instrucciones inscritas en el televisor o descritas en el manual de instrucciones o de reparación.

ADVERTENCIA

Para protegerse contra daños personales, siga las precauciones de seguridad básicas durante la instalación, la utilización y el mantenimiento del televisor indicadas a continuación.

Utilización

Fuentes de alimentación

Este aparato solamente deberá alimentarse con el tipo de fuente de alimentación indicado en la etiqueta de serie/modelo. Si no está seguro sobre el tipo de red eléctrica de su hogar, consulte a su proveedor o a la compañía de suministro eléctrico local. Con respecto a los aparatos diseñados para utilizarse con baterías, consulte el manual de instrucciones.

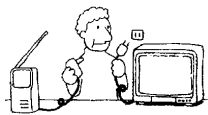

Para un televisor con clavija del cable de alimentación polarizado

Esta clavija solamente encajará en la toma de alimentación de una sola forma. Ésta es una medida de seguridad. Si no es capaz de insertar completamente la clavija en la toma de alimentación, pruebe invirtiéndola. Si la clavija sigue sin poder insertarse, póngase en contacto con un electricista para que le instale una toma adecuada. No elimine la finalidad de seguridad del enchufe polarizado insertándolo con fuerza.

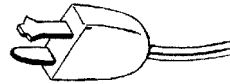

Conexión a tierra o polarización

Este aparato dispone de una clavija del cable de alimentación polarizado (una cuchilla de la clavija es más ancha que la otra), o con tres terminales (el tercero es para puesta a tierra). Siga las instrucciones indicadas a continuación:

Advertencia alternativa

Para un televisor con clavija de tres terminales con conexión a tierra

Esta clavija solamente podrá insertarse en una toma de la red con conexión a tierra. Ésta es una medida de seguridad. Si no es capaz de insertar completamente la clavija en la toma de alimentación, póngase en contacto con un electricista para que le instale una toma adecuada. No elimine la finalidad de seguridad de la clavija de 3 terminales insertándolo con fuerza.

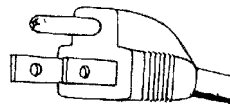

Sobrecarga

No sobrecargue las tomas de alimentación, los cables prolongadores ni tomacorrientes de derivación sobrepasando su capacidad, porque esto podría resultar en incendios o cortocircuitos. Apague siempre el aparato cuando no lo utilice. Cuando vaya a dejar el aparato sin usar durante mucho tiempo, desconéctelo de la alimentación como protección contra la posibilidad de un mal funcionamiento interno que pudiese provocar el peligro de incendio.

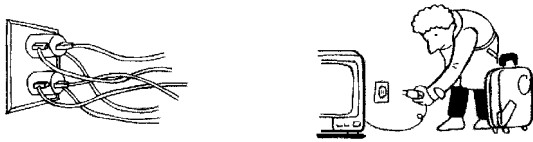

No desconecte la antena ni el cable de alimentación durante tormentas fuertes. Podría recibir una descarga eléctrica mientras agarra el cable, causándole graves daños. Apague el televisor y espere a que las condiciones meteorológicas mejoren.

Introducción de objetos y líquidos

No introduzca nunca objetos de ningún tipo a través de las ranuras del gabinete, ya que podrían tocar puntos de tensión peligrosa o cortocircuitar partes, lo que podrían resultar en incendios o descargas eléctricas. No vierta nunca ningún tipo de líquido sobre el aparato.



Accesorios

No utilice nunca ningún accesorio no recomendado por el fabricante, ya que podrían ser peligrosos.

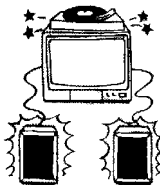

No coloque objetos, especialmente los pesados, sobre el aparato. El objeto puede caerse del televisor, causándole heridas.

Limpieza

Antes de limpiar el televisor, desconéctelo de la alimentación. No utilice limpiadores líquidos ni aerosoles. Para limpiar el exterior del aparato, emplee un paño ligeramente humedecido en agua.

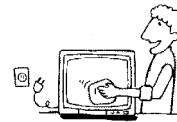

Si un televisor en funcionamiento emite crujidos o detonaciones continuos o frecuentes, desconéctelo y consulte a su proveedor o a un radiotécnico. Es normal que algunos televisores produzcan estos ruidos, especialmente al conectar o desconectar su alimentación.

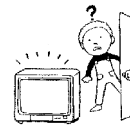

Instalación

Son precisas dos o más personas para levantar o mover el aparato. El aparato es pesado y la superficie inferior es plana. Si el aparato lo mueve una sola persona o si se maneja en lugares inestables, pueden producirse daños graves. Instale el aparato sobre una superficie estable y nivelada.

Agua y humedad

No utilice aparatos que requieran de alimentación eléctrica cerca del agua, por ejemplo, cerca de una bañera, un lavabo, un fregadero o una lavadora en un sótano húmedo, ni cerca de una piscina, etc.

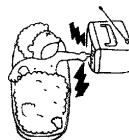

Colocación

No coloque el aparato sobre una mesita con ruedas, un pedestal, un trípode, una abrazadera, una mesa o un estante inestable. El televisor podría caerse causando daños serios a niños, adultos, y al propio televisor. Utilice solamente la mesita con ruedas o soporte recomendado por el fabricante para el modelo específico de TV. El montaje del producto se debe hacer según las instrucciones del fabricante y usted debe usar un accesorio de montaje recomendado por el fabricante. La combinación de un televisor y un mueble con ruedas deberá moverse con cuidado. Las paradas repentinas, la fuerza excesiva y las superficies desiguales podrían hacer que se cayese tal combinación.

Desconecte todos los cables del aparato antes de moverlo.



No permita que niños ni mascotas se suban al aparato ni que lo empujen. El televisor podría caerse, causando daños graves.

Ventilación

Las ranuras y aberturas del gabinete y de la parte posterior o inferior son para permitir la ventilación necesaria. Para asegurar la operación fiable del televisor, y protegerlo contra el sobrecalentamiento, estas ranuras y aberturas no deberán cubrirse ni bloquearse nunca.

- **No bloquear nunca las ranuras ni aberturas con paños ni otros materiales.**

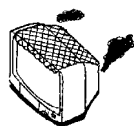

- **No bloquee nunca las ranuras ni aberturas colocando el televisor sobre una cama, sofá, alfombra u otras superficies similares.**

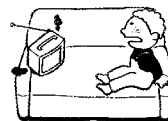

- **No coloque nunca el televisor en un lugar cerrado, como en un librero o un mueble empotrado, a menos que esté adecuadamente ventilado.**

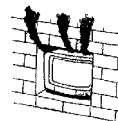

- **No coloque el televisor cerca ni sobre un radiador o una salida de aire caliente, ni expuesto a la luz solar directa.**



Protección del cable de alimentación

No permita que ningún objeto quede sobre el cable de alimentación, ni coloque el televisor donde el cable pueda quedar sometido a desgaste o presión.

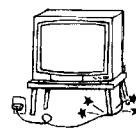

Conexión a tierra o polarización

Es posible que este aparato venga equipado con un enchufe de corriente alterna polarizado (un enchufe que tiene una pata más ancha que la otra). Este enchufe calza en el tomacorriente de una manera solamente. Esto es una función de seguridad. Si usted no puede insertar el enchufe por completo en el tomacorriente, trate de darlo vuelta. Si todavía el enchufe no entra, comuníquese con un electricista para que cambie el tomacorriente obsoleto. No rechace el propósito de seguridad del enchufe polarizado.

Antenas

Conexión a tierra de la antena exterior

Cuando instale una antena exterior, tenga en cuenta las precauciones siguientes. Un sistema de antena exterior no deberá colocarse cerca de líneas de alta tensión ni otros circuitos de iluminación o alimentación, ni donde pueda entrar en contacto con tales líneas o circuitos.

CUANDO INSTALE UN SISTEMA DE ANTENA EXTERIOR, TENGA EXTREMADO CUIDADO PARA EVITAR QUE ENTRE EN CONTACTO CON TALES LÍNEAS DE ALIMENTACIÓN O CIRCUITOS, YA QUE TAL CONTACTO PODRÍA RESULTAR INVARIABLEMENTE FATAL.

Cerciórese de que el sistema de antena esté puesto a tierra a fin de que proporcione cierta protección contra sobretensiones y cargas estáticas. La Sección 810 del Código Eléctrico Nacional (NEC) de EE.UU., y la Sección 54 del Código Eléctrico Canadiense ofrecen información con respecto a la puesta a tierra adecuada de una unidad de descarga de antena, el tamaño de los conductores de conexión a tierra, la ubicación de la unidad de descarga de antena, la conexión a los electrodos de conexión a tierra, y los requisitos de tales electrodos.

Conexión a tierra de la antena de acuerdo con el Código Eléctrico Nacional

Con respecto a la conexión a tierra de la antena, consulte la sección 54-300 del Código Eléctrico Canadiense.

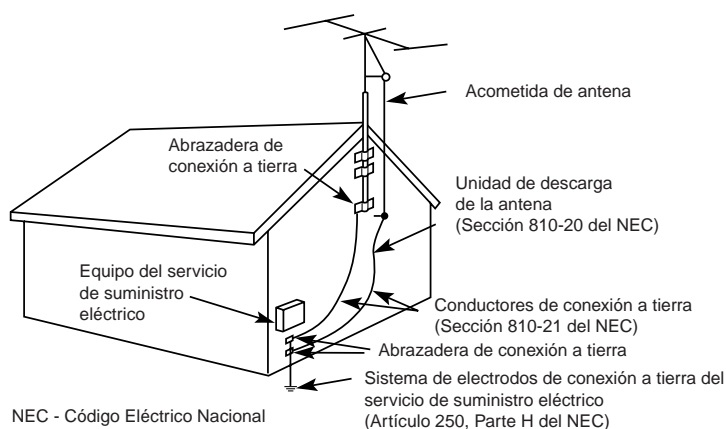

En caso de descarga eléctrica

Para evitar daños al televisor debido a una descarga eléctrica o a una sobretensión de corriente durante una tormenta, o cuando no se encuentre en uso por largos periodos de tiempo, desconecte el cable a la toma de corriente de la pared y desconecte la antena. Esto impedirá que el receptor se dañe.

Mantenimiento

Daños que requieren reparación

Desconecte el televisor de la toma de alimentación y solicite los servicios de personal de reparación calificado en las condiciones siguientes:

- Cuando el cable o la clavija de alimentación esté dañado.

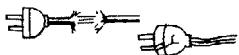

- Si dentro del televisor se ha derramado líquido o se cayeron objetos adentro del producto.

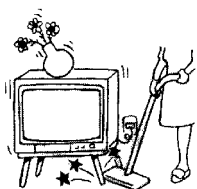

- Si el televisor ha estado expuesto a la lluvia o al agua.



- Si el televisor ha recibido un golpe fuerte al caer, o se daña el gabinete.

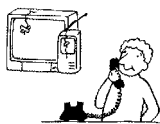

- Si el televisor no funciona normalmente al seguir las instrucciones de operación. Ajuste solamente los controles especificados en el manual de instrucciones. El ajuste inadecuado de otros controles podría resultar en daños que podrían requerir la intervención costosa de un técnico calificado a fin de devolver el televisor a su funcionamiento normal.



- Cuando el rendimiento del televisor haya cambiado notablemente, significará que es necesario repararlo.

Reparación

No intente reparar por sí mismo el aparato, ya que al abrir el gabinete se vería expuesto a tensiones peligrosas y otros riesgos. Solicite los servicios de personal de reparación calificado.



Piezas de reemplazo

Cuando se haya requerido el reemplazo de piezas, solicite al técnico de reparación un certificado por escrito de que ha utilizado las piezas de repuesto con las mismas características que las originales, especificadas por el fabricante. La sustitución no autorizada de piezas podría resultar en incendios, descargas eléctricas, u otros peligros.

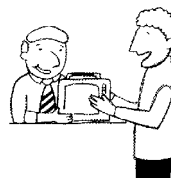

Comprobación de seguridad

Después de haber finalizado cualquier servicio de mantenimiento o reparación, solicite al técnico de reparación que realice y certifique las comprobaciones de seguridad rutinarias (como especifica el fabricante) para determinar si el televisor se encuentra en condiciones de funcionar con seguridad. Cuando finalice la vida útil del televisor, el deshacerse inadecuadamente de él podría provocar la implosión del tubo de imagen. Solicite este servicio a un técnico calificado.



Índice

Introducción

Funciones del televisor Trinitron® a color	1
Baterías para el control remoto	2
Acerca de este manual	2







Conexión del televisor

Conexiones básicas.....	3
Conexiones de decodificador	4
Conexión de equipo adicional.....	6

Uso del control remoto y las funciones básicas

Uso del control remoto	15
Programación automática del televisor	17
Uso de Imagen en imagen (PIP).....	18
Acceso rápido a los menús.....	20

Uso de los menús

Para acceder a un menú	22
Uso del menú de Video 	23
Uso del menú de Audio 	24
Uso del menú de Ajuste de Canal 	26
Uso del menú Paterno 	28
Uso del menú de Reloj 	29
Uso del menú de Ajustes 	30
Uso del menú Básico 	31

Información adicional

Programación del control remoto	32
Solución de problemas	36
Especificaciones	39

Índice alfabético	41
--------------------------------	----

Introducción

Gracias por haber comprado el televisor Trinitron® a color de Sony. Antes de utilizar este manual, verifique el número de modelo localizado en la parte posterior del televisor o en la portada de este manual.

Funciones del televisor Trinitron® a color

A continuación se enumeran las características del televisor:

- ❑ **CRT PLANO** — Nueva pantalla tecnológicamente avanzada para obtener una óptima calidad de imagen.
- ❑ **Control Paterno** — Herramienta diseñada para que los padres puedan controlar el acceso de los niños al televisor mediante el establecimiento de límites de utilización.
- ❑ **Canal Favorito** — Acceso instantáneo a los canales preferidos con sólo tocar un botón.
- ❑ **Imagen en imagen (PIP)** — Permite visualizar dos canales simultáneamente (KV-29FV17, KV-29FV17C solamente).
- ❑ **Control remoto universal** — Programe su control remoto para utilizar el decodificador, la videocasetera, el receptor de satélite digital o el reproductor DVD conectado.
- ❑ **Energy Star®** — Símbolo reconocido de eficiencia energética.
- ❑ **S VIDEO** — Entrada de video que ofrece una calidad de imagen mejorada.
- ❑ **MTS directo** — Proporciona acceso directo para cambiar el sonido multicanal del televisor: Estéreo, Mono o Auto-SAP (segundo programa de sonido), con sólo tocar un botón.
- ❑ **Menús bilingües** — Elija entre los menús Inglés o Español.
- ❑ **Controles del panel frontal** — Proporcionan acceso a los menús en pantalla sin necesidad de utilizar control remoto.
- ❑ **Entradas A/V frontales** — Conexión rápida para videojuegos, cámaras de video o equipo estéreo/mono.

Baterías para el control remoto

Inserte dos baterías tamaño AA (R6) (incluidas con el televisor) en el control remoto como se indica en la siguiente ilustración.

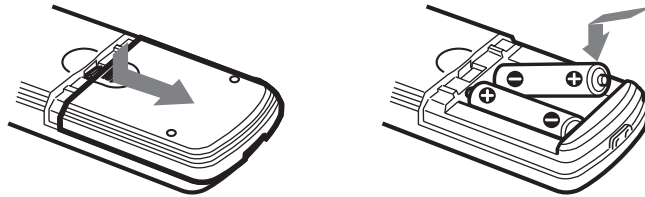

✎ En condiciones normales, las baterías durarán un máximo de seis meses. Si el control remoto no funciona correctamente, es posible que las baterías estén agotadas.

✎ Cuando el control remoto no vaya a utilizarse durante un periodo prolongado, quite las baterías para evitar que fugas de las mismas dañen su control remoto.

✎ Su control remoto puede programarse para hacer funcionar la mayoría de los equipos de video (consulte la página 32).

Acercas de este manual

En este manual se proporcionan las instrucciones necesarias para que disfrute de su nuevo televisor. Asimismo, se indica cómo conectar el televisor a una antena o cable, decodificador, videocasetera, reproductor DVD, receptor de satélite, sistema estereofónico o cámara de video. Una vez realizada la conexión, siga las instrucciones y utilice el control remoto para acceder a los menús en pantalla.

✎ Los paneles frontal y posterior del televisor que aparecen en las ilustraciones de este manual corresponden a los modelos KV-29FS13 y KV-29FS13C. El panel posterior mostrado en la página 13 corresponde a los modelos KV-29FV17 y KV-29FV17C. Es posible que sus paneles frontal y posterior no tengan el mismo aspecto que los que se muestran en la ilustración.

Conexión del televisor

Lea este capítulo antes de configurar el televisor por primera vez. En esta sección se incluyen las conexiones básicas, así como la conexión de cualquier otro equipo.

Conexiones básicas

Televisor con antena interior o exterior, o cable CATV

Dependiendo del cable disponible, elija una de las conexiones siguientes:

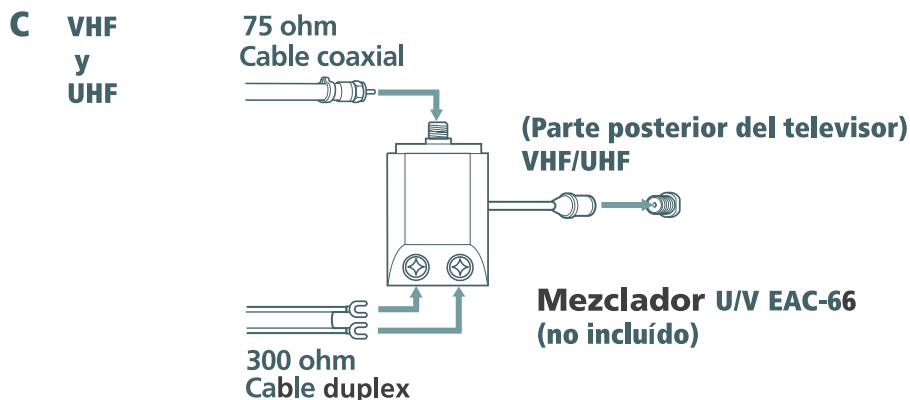
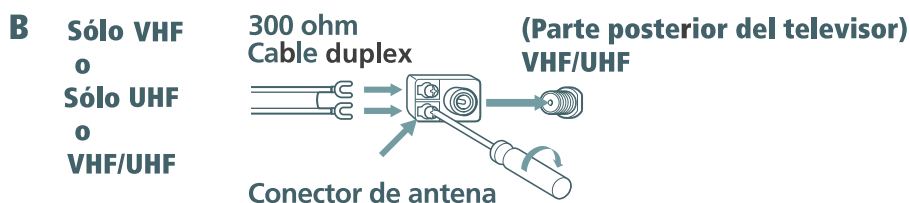
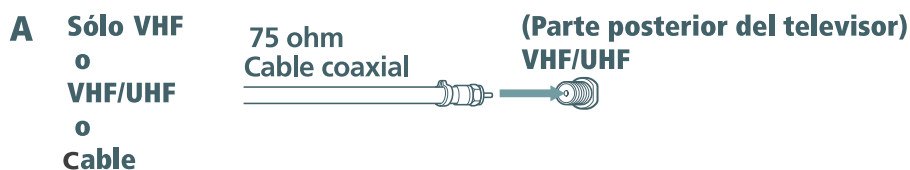

 Si realiza la conexión a una antena interior o exterior, es posible que necesite ajustar la orientación de la antena para obtener el mejor nivel de recepción.

Conexiones de decodificador

Algunos sistemas de televisión por cable usan señales deformadas o codificadas que requieren un decodificador para poder ver todos los canales. Si se suscribe a dicho tipo de servicio de cable, utilice esta conexión. Las señales codificadas que recibe el televisor mediante el decodificador no pueden visualizarse en PIP. Si algunos canales están codificados, considere el uso de la conexión de decodificador y cable (consulte la página 5).

Decodificador y televisor

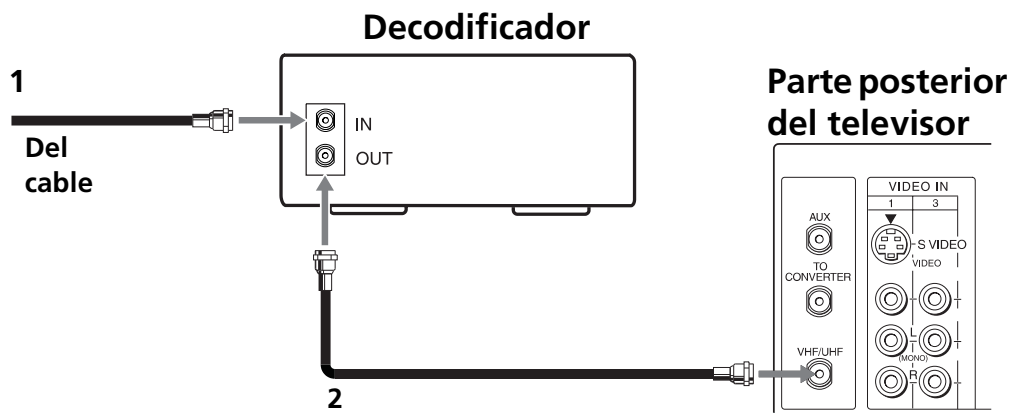

- 1** Conecte el cable coaxial del servicio de cable a la entrada IN de su decodificador.
- 2** Empleando un cable coaxial (no incluido), conecte la salida OUT de su decodificador a la entrada VHF/UHF de su televisor.

 Si va a hacer la selección de todos los canales a través de su decodificador, debe considerar la posibilidad de usar la función Fijar Canal ajustando el televisor en el canal 3 o 4 (consulte la página 27).

Decodificador y cable

Utilice esta conexión si se suscribe a un sistema de cable que codifique algunos canales (canales de pago), pero no todos. Esta configuración permite utilizar el control remoto para:

- a) cambiar de canal mediante el decodificador cuando se recibe una señal codificada, y
- b) cambiar de canal mediante el televisor.

Esta conexión permite también utilizar la función PIP cuando se visualizan canales no codificados que el televisor recibe directamente del cable. Las señales codificadas transmitidas mediante el decodificador no pueden visualizarse en PIP. Para obtener más información sobre la función PIP, (consulte la página 18).

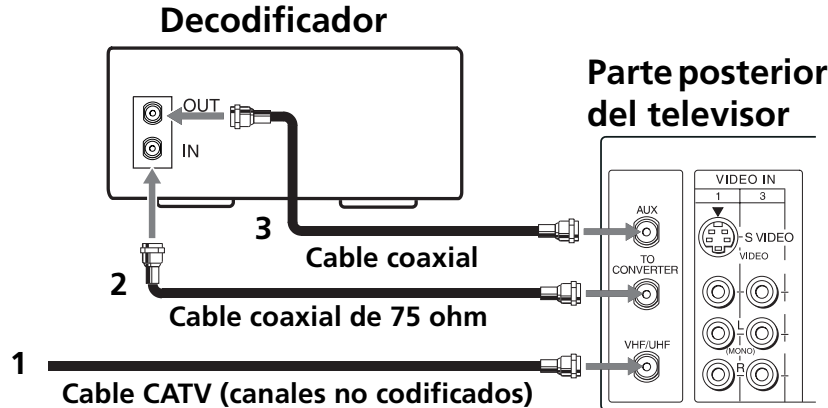

- 1** Conecte el cable coaxial de su servicio de cable a la entrada VHF/UHF de su televisor.
- 2** Empleando un cable coaxial (no incluido), conecte la entrada IN de su decodificador a la entrada TO CONVERTER de su televisor.
- 3** Empleando un cable coaxial (no incluido), conecte la salida OUT de su decodificador a la entrada AUX de su televisor.

Al oprimir el botón **ANT** del control remoto, las entradas de decodificador y de cable directo cambian.

Su control remoto Sony puede programarse para hacer funcionar su decodificador (consulte la página 32).

Con el fin de utilizar el decodificador para cambiar de canal, ajuste el televisor en el canal 3 o 4. El ajuste de la función Fijar Canal garantiza que los canales no cambien accidentalmente utilizando el televisor (consulte la página 27).

Conexión de equipo adicional

Televisor y videocasetera

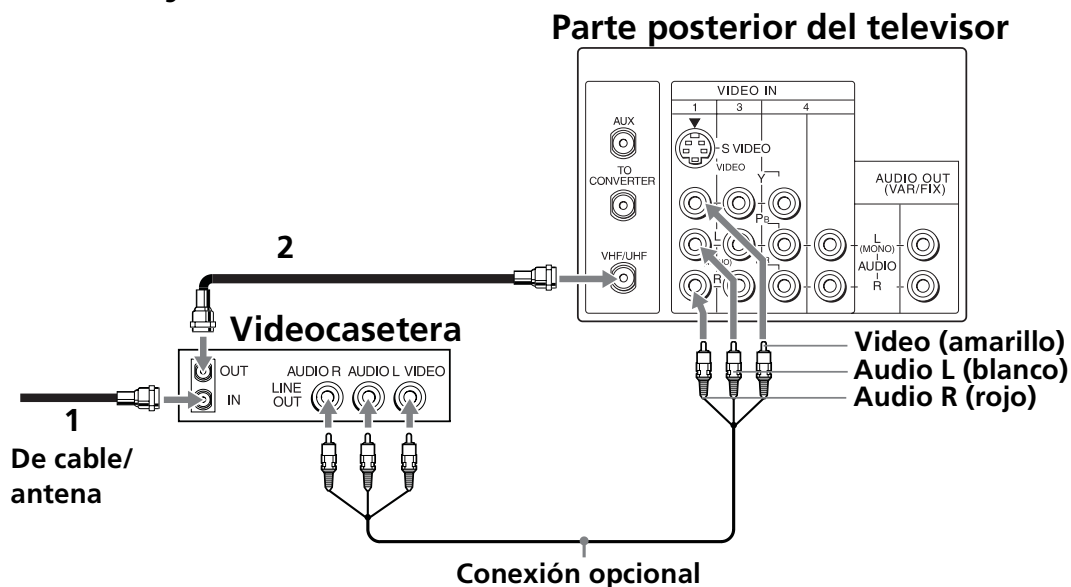

Para ver programas de video desde la videocasetera, sintonice el televisor con el canal 3 o 4 (como esté ajustado en la parte posterior de la videocasetera).

- 1 Conecte el cable coaxial de la antena del televisor o del servicio de cable a la entrada IN de su videocasetera.
- 2 Empleando un cable coaxial (no incluido), conecte la salida OUT de su videocasetera a la entrada VHF/UHF de su televisor.

Conexión opcional

Si la videocasetera está equipada con salidas de video, puede obtener mejor calidad de imagen conectando cables de Audio/Video (no incluidos) de las salidas AUDIO y VIDEO OUT de su videocasetera a las entradas AUDIO/VIDEO IN de su televisor.

Para obtener una calidad de imagen óptima, utilice S VIDEO en lugar del cable de Audio / Video amarillo. Puesto que S VIDEO no proporciona sonido, es preciso conectar los cables de audio.

Puede utilizar el botón para cambiar entre las entradas de VHF/UHF y VIDEO.

Televisor, videocasetera y decodificador

Utilice esta conexión si se suscribe a un sistema de cable que codifique algunos canales (canales de pago), pero no todos. Esta configuración permite utilizar el control remoto para:

- a) cambiar de canal mediante el decodificador o la videocasetera cuando se recibe una señal codificada, y
- b) cambiar de canal mediante el televisor.

Esta conexión permite también utilizar la función PIP cuando se visualizan canales no codificados que el televisor recibe directamente del cable. Las señales codificadas transmitidas mediante el decodificador no pueden visualizarse en PIP. Para obtener más información sobre la función PIP, (consulte la página 18).

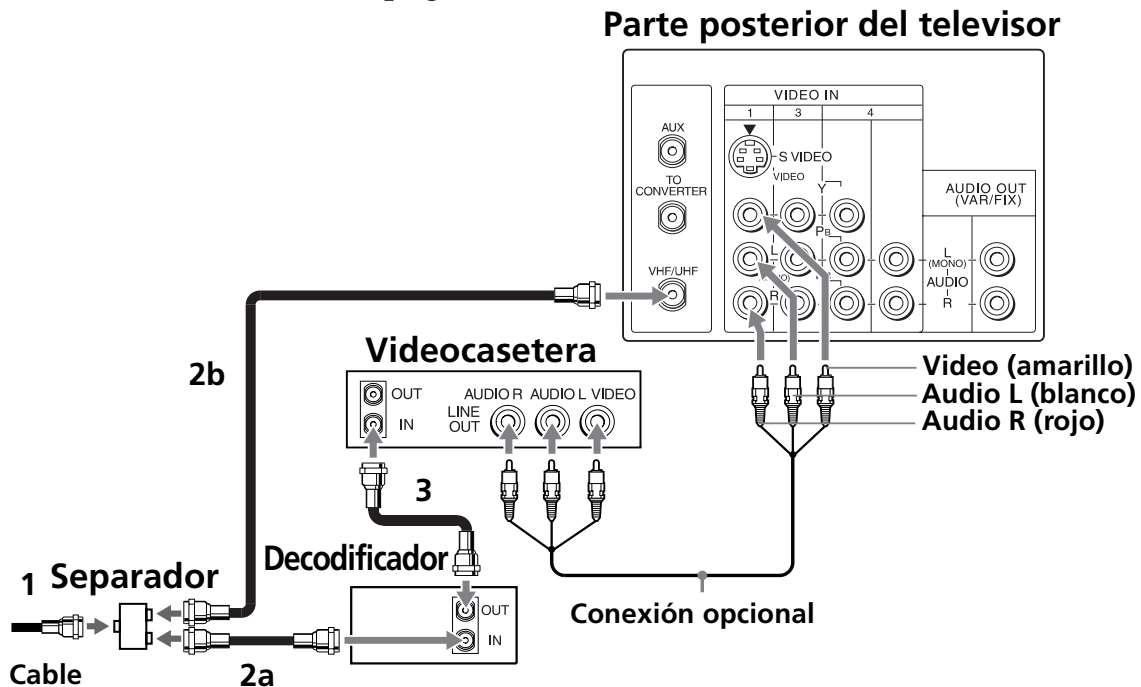



- 1 Conecte la toma de entrada única del separador a la conexión de cable entrante.
- 2 Con un cable coaxial (no incluido), conecte las dos tomas de salida del separador a:
 - a) la entrada IN del decodificador, y
 - b) la entrada VHF/UHF del televisor.
- 3 Empleando un cable coaxial (no incluido), conecte la salida OUT de su decodificador a la entrada IN de su videocasetera.

(continúa)

-  Si va a hacer la selección de todos los canales a través de su decodificador, debe considerar la posibilidad de usar la función Fijar Canal ajustando el televisor en el canal 3 o 4 (consulte la página 27).

Conexión opcional

Si la videocasetera está equipada con salidas de video, puede obtener mejor calidad de imagen conectando cables de Audio/Video (no incluidos) de las salidas AUDIO y VIDEO OUT de su videocasetera a las entradas AUDIO/VIDEO IN de su televisor.

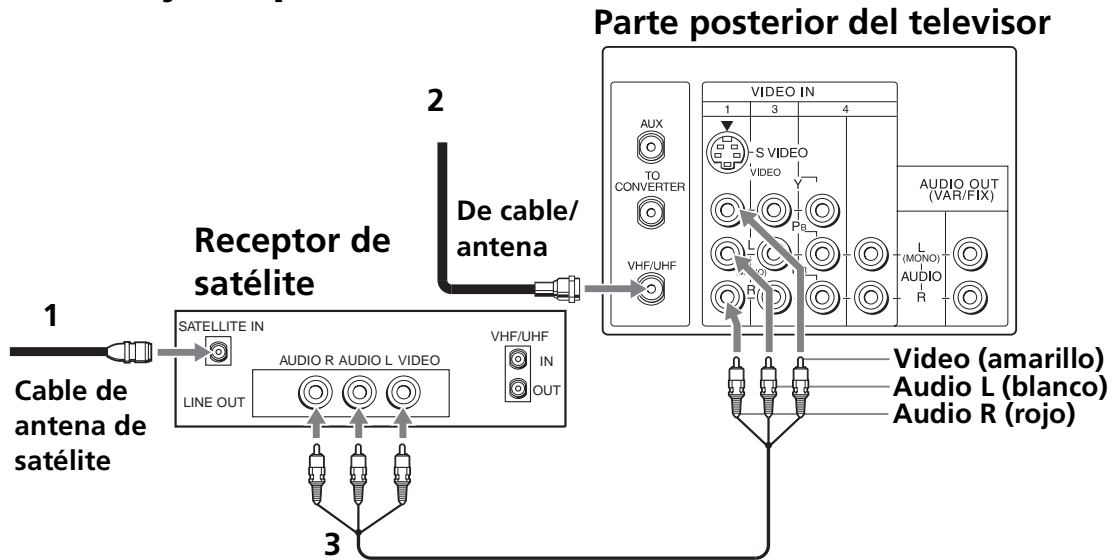

-  Para obtener una calidad de imagen óptima, utilice S VIDEO en lugar del cable de Audio/Video amarillo. Puesto que S VIDEO no proporciona sonido, es preciso conectar los cables de audio.
-  Puede utilizar el botón  para cambiar entre las entradas de VHF/UHF y VIDEO.

Televisor y receptor de satélite



- 1** Conecte el cable de su antena de satélite a la entrada SATELLITE IN de su receptor de satélite.
- 2** Conecte el cable coaxial de su sistema de cable o antena a la entrada VHF/UHF de su televisor.
- 3** Con cables de Audio/Video (no incluidos), conecte las salidas AUDIO y VIDEO OUT de su receptor de satélite a las entradas AUDIO y VIDEO IN de su televisor.

 Para obtener una calidad de imagen óptima, utilice S VIDEO en lugar del cable de Audio/Video amarillo. Puesto que S VIDEO no proporciona sonido, es preciso conectar los cables de audio.

 Puede utilizar el botón  para cambiar entre las entradas de VHF/UHF y de receptor de satélite.

Televisor, receptor de satélite y videocasetera

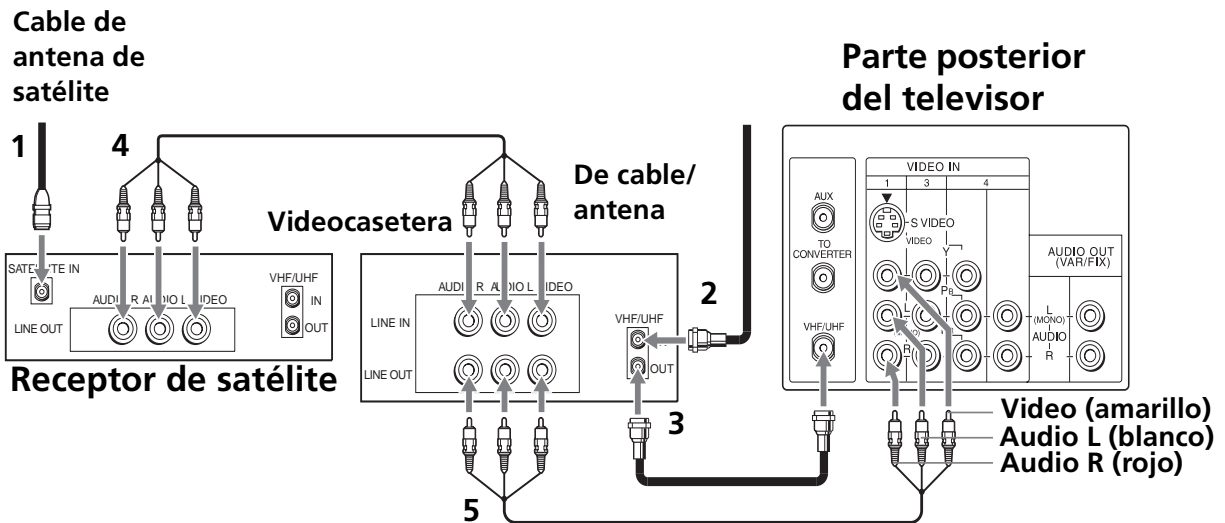

- 1** Conecte el cable de su antena de satélite a la entrada SATELLITE IN de su receptor de satélite.
- 2** Conecte el cable coaxial de su sistema de cable o antena a la entrada IN de su videocasetera.
- 3** Empleando un cable coaxial (no incluido), conecte la salida OUT de su videocasetera a la entrada VHF/UHF de su televisor.
- 4** Con cables de Audio/Video (no incluidos), conecte las salidas AUDIO y VIDEO OUT de su receptor de satélite a las entradas AUDIO y VIDEO IN de su videocasetera.
- 5** Con cables de Audio/Video (no incluidos), conecte las salidas AUDIO y VIDEO OUT de su videocasetera a las entradas AUDIO y VIDEO IN de su televisor.

 Para ver la entrada del receptor de satélite o de la videocasetera, seleccione la entrada de video a la que esté conectado el receptor o la videocasetera; para ello, oprima TV/VIDEO en el control remoto.

Conexión de una cámara de video

Con cables de Audio/Video (no incluidos), conecte las salidas AUDIO y VIDEO OUT de su cámara de video a las entradas AUDIO y VIDEO IN de su televisor.

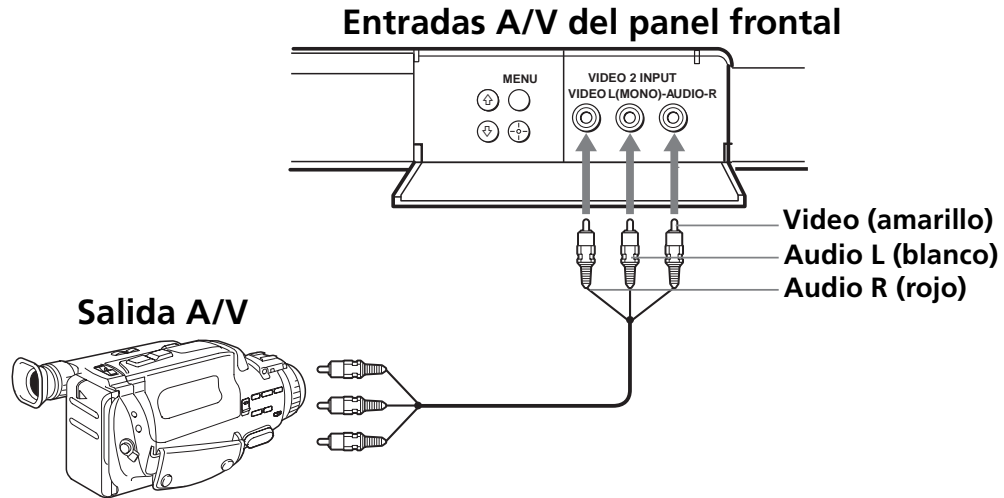

Si dispone de una cámara de video equipada de S VIDEO, podrá utilizar un cable S VIDEO para obtener imágenes de óptima calidad.

Conexión de un reproductor DVD

Con cables de Audio/Video (no incluidos), conecte la salida de AUDIO y VIDEO OUT de su reproductor DVD a las entradas AUDIO y VIDEO IN de su televisor.

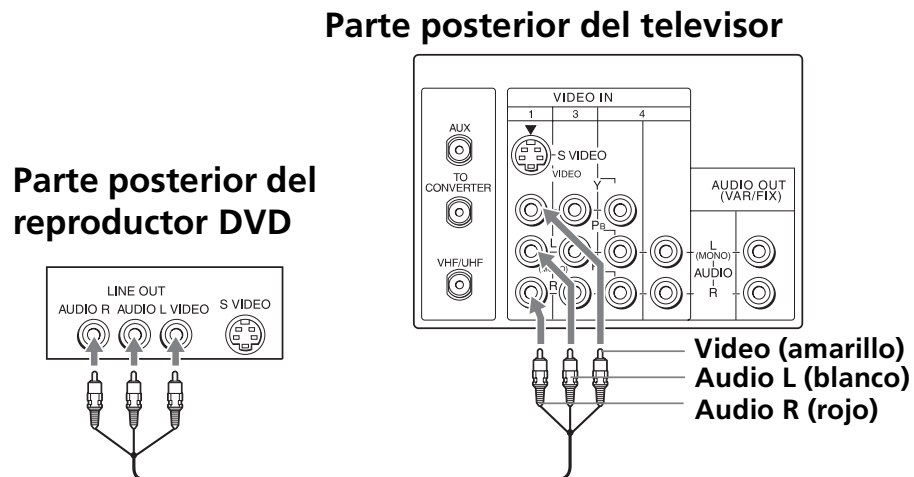



Para obtener una calidad de imagen óptima, utilice S VIDEO en lugar del cable de Audio / Video amarillo. Puesto que S VIDEO no proporciona sonido, es preciso conectar los cables de audio.

Conexión de un sistema de audio

Con cables de audio (no incluidos), conecte la salida AUDIO OUT de su televisor a una de las entradas de línea que no se utilice (p.ej. TV, AUX, TAPE2) de su sistema estéreo.

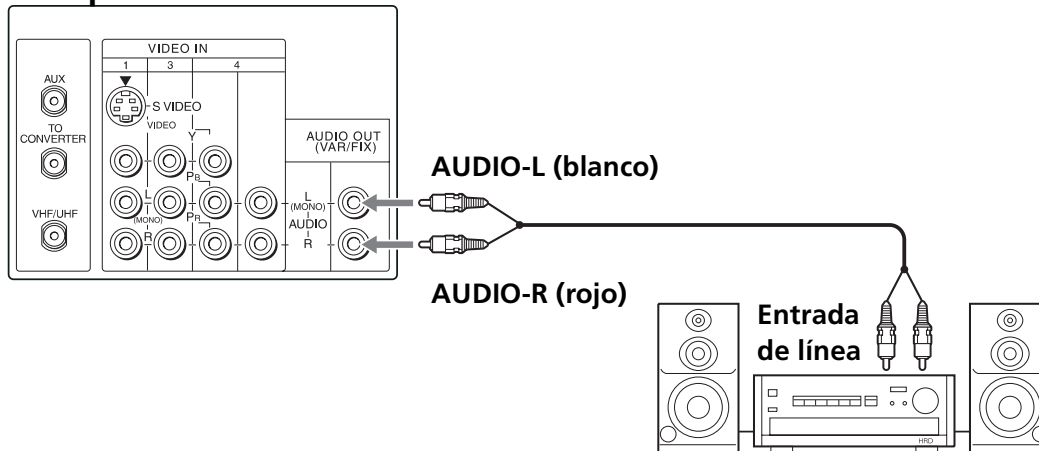
Parte posterior del televisor



 Ajuste el sistema estéreo en la entrada de línea seleccionada. Consulte la página 24 para obtener instrucciones complementarias sobre ajustes de audio.

Conexión de dos videocaseteras para edición de cintas

Sólo KV-29FV17 y KV-29FV17C

Puede conectar dos videocaseteras para editar cintas de video. También puede conectar ambas videocaseteras a su televisor para ver el programa en grabación.

Parte posterior del televisor (sólo KV-29FV17 y KV-29FV17C)

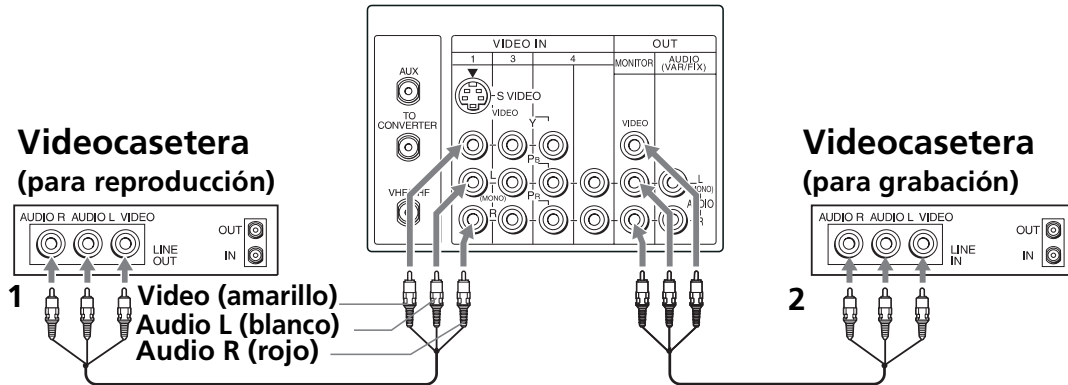

- 1 Con un cable de Audio/Video (no incluido), conecte las salidas AUDIO y VIDEO OUT de su primera videocasetera a las entradas AUDIO y VIDEO IN de su televisor.
- 2 Con un cable de Audio/Video (no incluido), conecte las salidas AUDIO y VIDEO OUT de la segunda videocasetera a las salidas MONITOR AUDIO y VIDEO OUT de su televisor.



Para editar cintas, ajuste el televisor en la entrada de video destinada a la reproducción; para ello, oprima .

Uso del control remoto y las funciones básicas

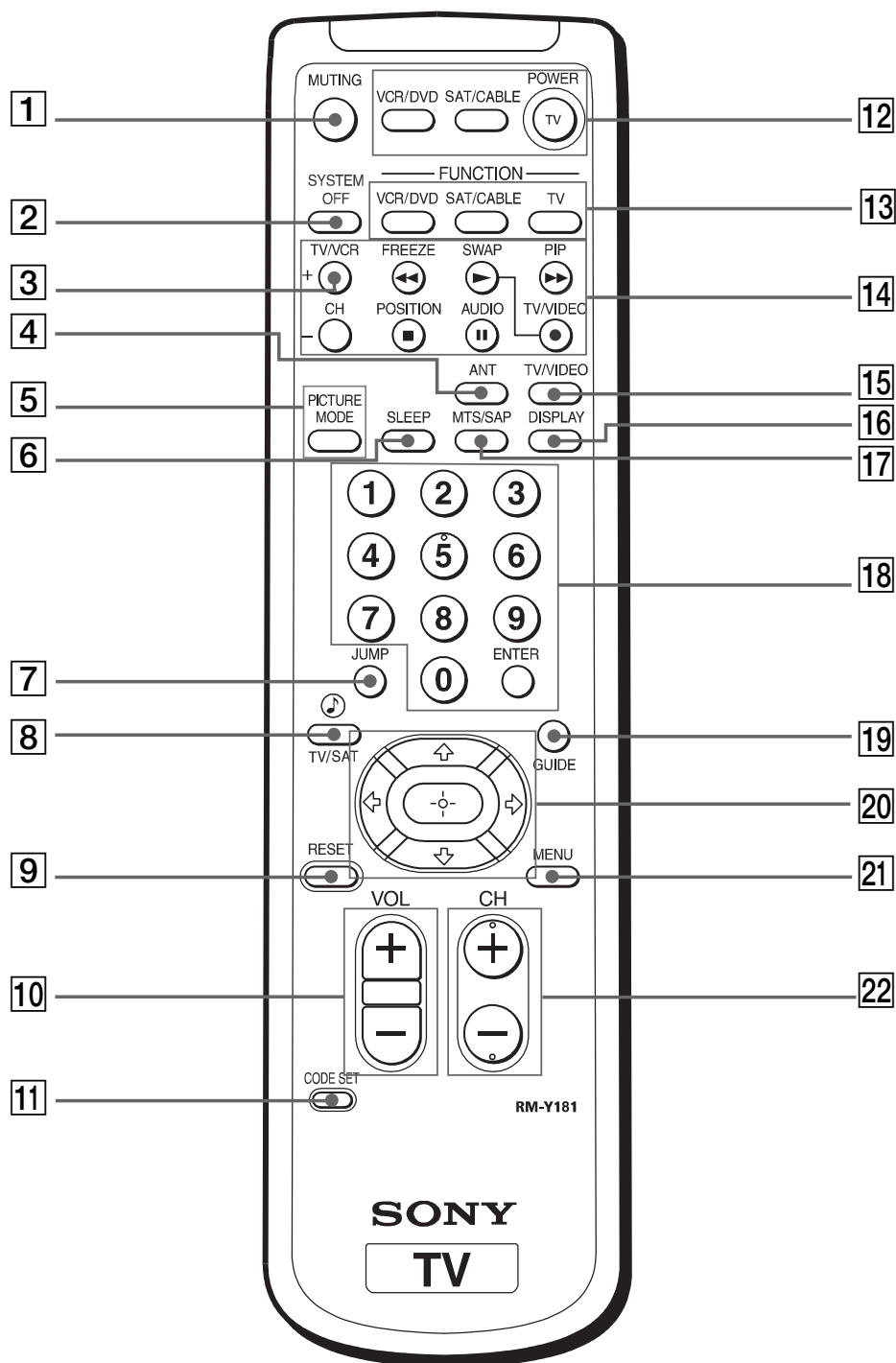
En esta sección se explica cómo utilizar los botones más avanzados del control remoto, así como los menús en pantalla.





Uso del control remoto

Botón	Descripción
1 MUTING	Apaga el sonido instantáneamente. Oprímalo de nuevo u oprima  para encender el sonido de nuevo.
2 SYSTEM OFF	Apaga simultáneamente todos los equipos Sony (puede no funcionar con equipos más antiguos).
3 TV/VCR	Oprímalo cuando termine de utilizar una videocasetera y desee cambiar a la entrada de televisión. La alimentación de la videocasetera permanecerá activada.
4 ANT (antena)	Oprímalo para cambiar la entrada VHF/UHF a la entrada AUX (sólo KV-29FV17 y KV-29FV17C).
5 PICTURE MODE	Recorre cíclicamente los ajustes de modo de video disponibles.
6 SLEEP	Apaga el televisor automáticamente en 15, 30, 45, 60, 90 o 120 minutos aproximadamente. Para cancelar, oprímalo hasta que aparezca SLEEP OFF.
7 JUMP	Permite alternar entre los dos últimos canales seleccionados con los botones 0-9 .
8 	Recorre cíclicamente los ajustes de sonido estable (Steady Sound) disponibles (consulte la página 24).
9 RESET	Oprímalo para volver a los ajustes de fábrica desde un menú en pantalla.
10 VOL (volumen)	Oprímalo cuando desee ajustar el volumen.
11 CODE SET	Utilícelo para programar el control remoto con el fin de hacer funcionar equipos de video conectados (consulte la página 32).
12 POWER	Oprímalo para encender y apagar el equipo conectado.
13 FUNCTION	Oprímalo para controlar el equipo conectado mediante el control remoto.
14 Imagen en imagen (PIP)	Activa la función PIP. Para utilizar la función PIP, consulte la página 18.

 El control remoto mostrado en la página 14 (RM-Y181) es para los modelos KV-29FV17 y KV-29FV17C. Su control remoto puede no ser como el que aparece en las ilustraciones.

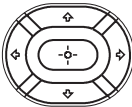
(continúa)

15	TV/VIDEO	Recorre cíclicamente las entradas de video disponibles.
16	DISPLAY	Oprímalo una vez para mostrar la hora actual (si está ajustada) y el número de canal. Para cancelar, oprímalo hasta que aparezca la indicación "DISPLAY OFF".
17	MTS/SAP	Oprima este botón para recorrer las opciones Multi-channel TV Sound (MTS) (opciones de sonido multicanal del televisor): Estéreo, Mono y Auto-SAP (segundo programa de sonido).
18	0-9 y ENTER	Permiten cambiar de canal directamente e introducir valores numéricos en indicaciones en pantalla.
19	GUIDE	Permite acceder a la guía personalizada del receptor de satélite.
20		Mueve el cursor por los menús en pantalla. Oprima los botones de flecha para mover el cursor. Oprima el botón central para seleccionar o acceder a una opción.
21	MENU	Muestra el menú en pantalla. Oprímalo de nuevo para salir del menú en cualquier momento.
22	CH (canal)	Oprímalo cuando desee cambiar de canal.

 Para obtener información sobre los botones de utilización de Imagen en imagen (PIP), consulte la página 18.



 Si pierde el control remoto, consulte la página 38.

Programación automática del televisor

Después de conectar el televisor, puede ejecutar Auto Programación para programar los canales.

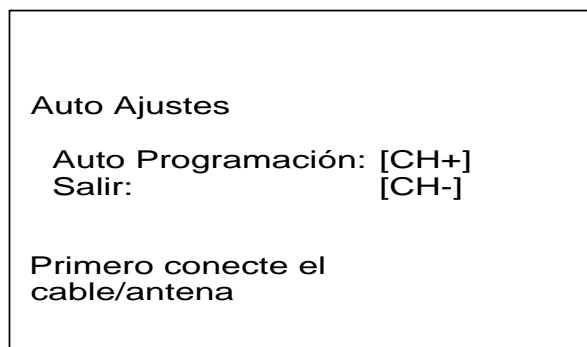









- 1 Oprima  para encender el televisor. Aparece la pantalla de ajuste inicial.





- 2 Oprima el botón TV FUNCTION.
- 3 Oprima  en el control remoto o en el panel frontal del televisor para realizar la Auto Programación, u oprima  para salir.

 La pantalla de ajuste inicial aparecerá cada vez que encienda el televisor hasta que ejecute Auto Programación.

Para volver a ejecutar Auto Programación

- 1 Oprima .
- 2 Oprima  para resaltar el menú Ajuste de Canal ().
- 3 Oprima  para resaltar Cable. Oprima  para seleccionar.
- 4 Oprima  o  para seleccionar SI o NO en función de cómo conectó su televisor. Oprima .
- 5 Oprima  para resaltar Auto Programación. Oprima  para buscar canales.

 Cuando termine Auto Programación, oprima  para salir.

Uso de Imagen en imagen (PIP)

La función Imagen en imagen (PIP) permite ver dos canales simultáneamente, uno al tamaño normal como imagen “principal” y el otro en una imagen pequeña conocida como “ventana”.

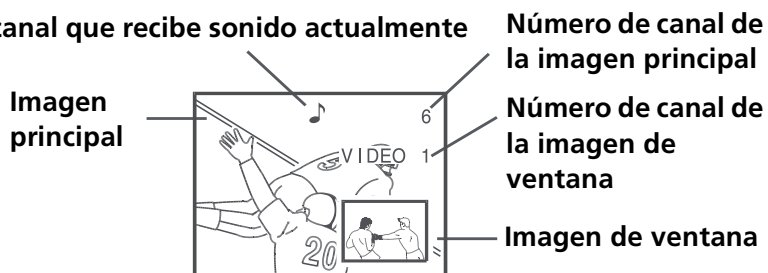

Sintonizador dual PIP

Sólo KV-29FV17, KV-29FV17C

Estos modelos están equipados con sintonizadores duales. Esto significa que PIP está “listo para utilizarse”.

	<p>Oprímalo para activar y desactivar la función PIP. Oprímalo varias veces para cambiar el tamaño de la imagen de ventana y para desactivar la función PIP.</p>
	<p>Oprímalo varias veces para recorrer cíclicamente las entradas de video disponibles del equipo de video que haya conectado al televisor.</p>
	<p>Oprima este botón para alternar entre el sonido de la imagen principal y el de la imagen de ventana. El símbolo de sonido aparece durante 3 segundos, indicando si escucha el sonido de la imagen principal o el de la de ventana.</p>
	<p>Oprímalo para cambiar de canal en la imagen de ventana. Para cambiar el canal de la ventana principal, utilice los botones CH+/- principales de la parte inferior del control remoto.</p>
	<p>Oprímalo para cambiar la ubicación de la imagen de ventana entre las cuatro esquinas de la pantalla.</p>
	<p>Oprímalo para congelar la imagen de ventana. Oprímalo de nuevo para restaurar la imagen.</p>
	<p>Oprímalo para cambiar la imagen principal y la de ventana. Oprímalo de nuevo para volver a cambiarlas.</p>



La entrada AUX no se puede ver en la imagen de ventana.

Para obtener más información sobre el control remoto, consulte la página 14.

Para utilizar PIP

- 1** Oprima el botón TV FUNCTION del control remoto para ver algún canal activo.
- 2** Oprima el botón  para que aparezca la imagen de ventana.
- 3** Utilice los botones de color amarillo del control remoto para controlar las funciones PIP. Consulte la página 18 para obtener descripciones sobre los botones de control de PIP.

Para comprobar la imagen PIP

- 1** Oprima el botón TV FUNCTION del control remoto para ver algún canal activo.
- 2** Oprima el botón  y seleccione de nuevo el mismo canal. En este momento, el mismo programa debe aparecer en las ventanas principal y de imagen.
- 3** Utilice los botones CH+/- amarillos para cambiar de canal en la ventana de imagen.
- 4** Utilice ahora los botones CH+/- principales de la parte inferior del control remoto para cambiar de canal en la ventana principal.
- 5** Oprima el botón  para cambiar a otras entradas de video de otros equipos que estén conectados a cualquiera de las tomas VIDEO IN del panel posterior del televisor. Debe ver una imagen diferente en la ventana PIP correspondientes a cada uno de los componentes de equipo de video conectados. Compruebe que el equipo conectado está encendido y en funcionamiento cuando realice esta prueba.
- 6** Si la función PIP no se activa correctamente con el televisor o el componente de equipo de video conectado, consulte la sección Solución de problemas en las páginas 37-38 para obtener posibles soluciones.

 Todos los equipos de video que haya conectado a la entrada AUX no pueden verse en la ventana PIP.

 Si ve todos los canales a través de un decodificador, la función PIP no se activará. Puesto que el decodificador sólo decodifica una señal cada vez, la imagen de ventana será la misma que la principal. No obstante, es posible visualizar un canal de cable y otra fuente de video. Compruebe que el reproductor DVD, videocasetera o receptor de satélite está conectado a las tomas VIDEO IN del panel posterior del televisor, no a la entrada AUX.

Acceso rápido a los menús

Los siguientes ajustes están disponibles en los menús en pantalla:

Menú	Permite
<p>Video Audio Canal Paterno Reloj Ajustes Básico</p> <p>Modo: Vívido Contraste Brillo Color Tinte Nitidez Calidez: Frío MV: Alto</p> <p>Mover Seleccionar Salir </p>	Hacer ajustes a la imagen.
<p>Video Audio Canal Paterno Reloj Ajustes Básico</p> <p>Agudos Graves Balance Auto Volumen: SI Efecto: NO MTS: Estéreo Bocinas: SI Salida: Variable</p> <p>Mover Seleccionar Salir </p>	Cambiar los ajustes de audio.
<p>Video Audio Canal Paterno Reloj Ajustes Básico</p> <p>Canal Favorito Cable: NO Fijar Canal: NO Auto Programación Omitir/Añadir Canal Nombre de Canal</p> <p>Mover Seleccionar Salir </p>	Personalizar los ajustes de canales.

Los menús ilustrados en este manual corresponden a los modelos KV-29FV17 y KV-29FV17C. Es posible que sus menús sean diferentes a estos.

Menú

Permite

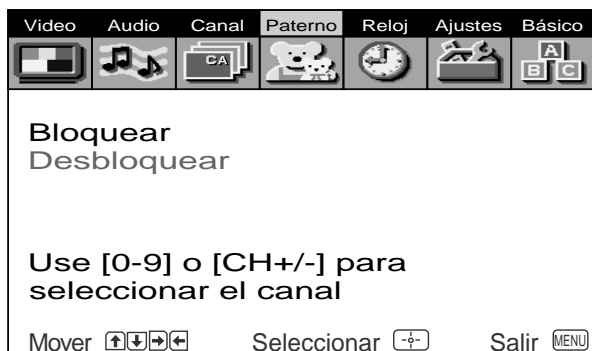

Definir límites de clasificación en su televisor basados en clasificaciones o contenidos de los programas.



Ajustar el reloj de su televisor y programar la visualización de programas específicos usando Reloj 1 y Reloj 2.



Programar canales, etiquetar entradas de video, seleccionar el idioma de los menús o ejecutar una demostración de éstos.











Seleccionar ajustes básicos para el televisor.

Uso de los menús

En esta sección se muestran las opciones disponibles para programar y ajustar su televisor.

Para acceder a un menú

- 1** Oprima  para visualizar el menú en pantalla.
- 2** Utilice  o  para resaltar el menú que desee y oprima .
- 3** Utilice los botones  o  para resaltar la opción que desee y oprima  (el ajuste ó las opciones de esa función aparecerá en la pantalla).
- 4** Oprima  para completar el ajuste.
- 5** Oprima  para salir del menú.

Uso del menú de Video

Para acceder el menú de Video, realice los siguientes pasos:





Modo
Visualización de imagen personalizada

Vívido: Seleccione este modo para aumentar el contraste y la nitidez de la imagen.

Estándar: Seleccione este modo para ver imágenes cotidianas.

Deportes: Seleccione este modo para ver imágenes con mas brillo.

Película: Seleccione este modo para ver imágenes con mayor detalle.

 Oprima  para acceder directamente a ajustes de Modo (Vívido, Estándar, Deportes, Película).

Contraste
Contraste de imagen

Oprima ⇐ para disminuir el contraste de la imagen.

Oprima ⇒ para aumentar el contraste de la imagen.

Brillo
Ajuste de la imagen

Oprima ⇐ para disminuir el brillo de la imagen.

Oprima ⇒ para aumentar el brillo de la imagen.

Color
Saturación del color

Oprima ⇐ para disminuir la saturación del color.

Oprima ⇒ para aumentar la saturación del color.

Tinte
Tonos del color

Oprima ⇐ para aumentar los tonos rojos.

Oprima ⇒ para aumentar los tonos verdes.

Nitidez
Detalle de la imagen

Oprima ⇐ para suavizar la imagen.

Oprima ⇒ para agudizar la imagen.

Calidez
Ajuste de intensidad del blanco

Frío: Proporciona un matiz azulado a los colores blancos.

Neutro: Proporciona un matiz neutro a los colores blancos.

Cálido: Proporciona un matiz rojizo a los colores blancos.

MV
Modulación de velocidad

Agudiza la definición de la imagen para que los objetos adquieran un borde perfilado. Seleccione una de las siguientes opciones: **Alto, Bajo, NO.**

Uso del menú de Audio

Para acceder el menú de Audio, realice los siguientes pasos:



- | | |
|---|--|
| Agudos | Oprima ⇐ para disminuir los sonidos agudos.
Oprima ⇒ para aumentar los sonidos agudos. |
| Graves | Oprima ⇐ para disminuir los sonidos graves.
Oprima ⇒ para aumentar los sonidos graves. |
| Balance | Oprima ⇐ para potenciar el sonido de la bocina izquierda.
Oprima ⇒ para potenciar el sonido de la bocina derecha. |
| Auto Volumen
<i>Estabiliza el volumen</i> | Oprima ⬆ o ⬇ para seleccionar una de las siguientes opciones:
SI: Selecciónelo para estabilizar el volumen al cambiar de canal.
NO: Selecciónelo para desactivar Auto Volumen. |

 Oprima  para seleccionar directamente ajustes de Auto Volumen.

- | | |
|---------------|--|
| Efecto | Oprima ⬆ o ⬇ para seleccionar una de las siguientes opciones:
NO: Recepción estereofónica o monofónica normal.
SRS: Produce sonido tridimensional dinámico para señales de audio estéreo (sólo KV-29FV17 y KV-29FV17C).
Simulado: Añade un efecto de sonido envolvente simulado en los programas monofónicos (sólo KV-29FV17 y KV-29FV17C).
Surround: Simula el sonido con calidad de sala de cine para programas estéreo (sólo KV-29FS13 y KV-29FS13C). |
|---------------|--|



MTS
Sonido multicanal

Estéreo: Selecciónelo cuando visualice una emisión en estéreo.

Mono: Selecciónelo para reducir el ruido en zonas de recepción deficiente.

Auto-SAP: Selecciónelo para que el televisor cambie automáticamente a un segundo programa de sonido (SAP) al recibirse una señal.

 Si el televisor está ajustado en Auto-SAP, puede que algunos programas no se oigan o que aparezcan distorsionados. Si el televisor no emite sonido, cambie los ajustes de Audio a Estéreo o Mono.

 Oprima  para realizar ajustes de MTS directamente (Estéreo, Mono, Auto-SAP).

Bocinas
Selección personalizada de fuentes de salida de audio

SI: Selecciónelo para escuchar el sonido a través de las bocinas del televisor con o sin un sistema estéreo independiente.

NO: Selecciónelo para desactivar las bocinas del televisor y escuchar el sonido de éste sólo a través de las bocinas de un sistema de sonido externo.

Salida
Utilícelo para controlar el volumen del televisor mediante un sistema estéreo

Utilice Salida solamente cuando haya un sistema de audio externo conectado al televisor.

Variable: Ajuste el volumen mediante el televisor.

Fija: Ajuste el volumen del televisor mediante un sistema estéreo conectado.

 Salida sólo puede ajustarse cuando Bocinas está desactivado (NO).

Uso del menú de Ajuste de Canal

Para acceder el menú de Ajuste de Canal, realice los siguientes pasos:





Canal Favorito

Acceso rápido a canales favoritos

Con el menú de Canal Favorito abierto:

- 1 Oprima **CA** para seleccionar.
- 2 Utilice los botones **↑** o **↓** para seleccionar Auto o Manual. Si selecciona Auto, aparecerán los últimos siete canales a los que acceso mediante los botones **0**-**9**.
- 3 Cuando se encuentre en Manual, oprima **←** y, a continuación, **↓** para seleccionar la posición (1-7) en la que desee ajustar un canal favorito. Después oprima **CA**.
- 4 Con los botones **↑** o **↓**, seleccione el canal deseado.
- 5 Oprima **CA** para cambiar al canal introducido. Oprima **MENU** para salir.

 Para utilizar Canal Favorito: Salga de todos los menús y oprima **CA**. Oprima **↓** o **↑** para desplazar el cursor al número de canal que desee, y oprima **CA**.

 Después de cerrar el menú, aparece la imagen de ventana PIP para que pueda previsualizar el canal favorito (sólo KV-29FV17 y KV-29FV17C).

Cable

SI: Selecciónelo si está recibiendo canales por cable con un cable CATV.

NO: Selecciónelo si está utilizando una antena de televisión.

 Después de cambiar los ajustes de cable, será necesario ejecutar Auto Programación.

Fijar Canal	<p>2-6: Selecciónelo cuando desee controlar la selección de todos los canales a través del decodificador o videocasetera. Seleccione el canal adecuado (normalmente 3 o 4) y utilice el control remoto del decodificador o de la videocasetera para la selección de canal.</p> <p>Video 1: Seleccione una de las entradas de video accesibles cuando esté conectado al equipo de video (p. ej., receptor de satélite) y quiera fijar su televisor a ésta.</p> <p>AUX 2-6: Utilice este ajuste en lugar de 2-6 si desea cambiar de canal mediante un decodificador, videocasetera o receptor de satélite y lo haya conectado a la entrada AUX (sólo KV-29FV17, KV-29FV17C).</p> <p>NO: Fijar Canal no se ajustará.</p>
Auto Programación	<p>Ejecute Auto Programación siempre que programe su televisor. Recorrerá todos los canales disponibles y programará los que se reciben.</p>
Omitir/Añadir Canal	<p>Utilice esta función después del ejecutar Auto Programación para omitir los canales que no desee o para añadir canales nuevos.</p> <ol style="list-style-type: none"> 1 Utilice los botones 0-9 o [CH+/-] para seleccionar el canal. 2 Oprima + para omitir o añadir (sólo habrá disponible una opción).
Nombre de Canal	<p>Con la ventana Nombre de Canal abierta:</p> <ol style="list-style-type: none"> 1 Oprima + y, a continuación, ↑ o ↓ hasta que llegue al número del canal deseado. 2 Oprima + para activar el canal. 3 Oprima ↓ y, a continuación, + para resaltar el campo de nombre. 4 Oprima ↑ o ↓ para visualizar el primer número o letra del nombre y oprima + para seleccionarlo. Cuando termine, oprima + para activarlo.

 Canal Favorito, Omitir/Añadir Canal y Nombre de Canal no pueden usarse cuando Fijar Canal está ajustado.

Uso del menú Paterno

Para acceder al menú Paterno, realice los siguientes pasos:

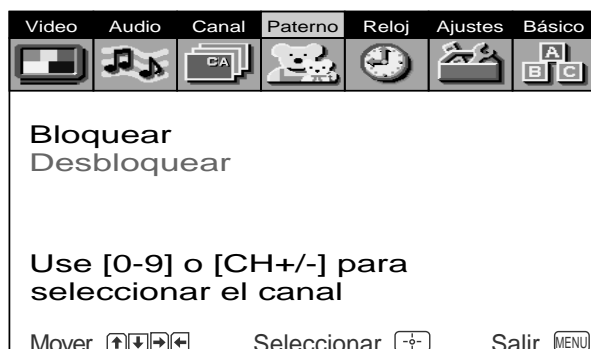

Con el menú Paterno abierto, oprima **+** para seleccionar Bloquear o Desbloquear:

Bloquear

Use **0-9** o **[CH +/-]** para elegir un canal que desee bloquear, y después oprima **+** para seleccionar.

 Cuando un canal se bloquea, aparece en forma de pantalla negra con la palabra "Bloqueado" sobre la pantalla (sólo en el uso normal de la TV).

Desbloquear

Use **0-9** o **[CH +/-]** para elegir el canal que desee desbloquear, y después oprima **+** para seleccionar.

 Para cancelar todos los canales bloqueados, abra el menú Paterno y oprima **RESET**.

Uso del menú de Reloj

Para acceder el menú de Reloj, realice los siguientes pasos:

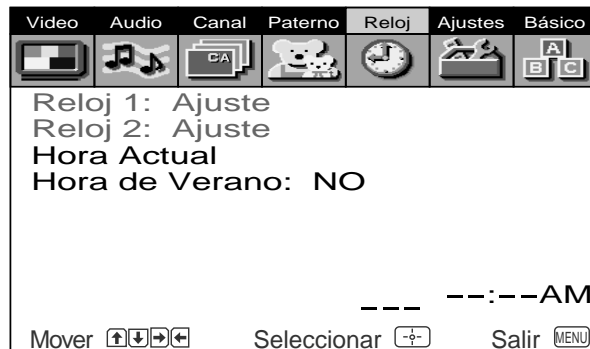



Hora Actual Con el menú abierto:

- 1 Oprima \uparrow o \downarrow para seleccionar la hora actual y, después, oprima Enter .
- (Si se encuentra en la Hora de Verano, asegúrese de ajustar Hora de Verano en "SI").
- 2 Oprima \uparrow o \downarrow para introducir la hora actual y, después, oprima Enter .
- 3 Oprima MENU para salir del menú.

Reloj 1 y Reloj 2 Con el menú abierto, coloque el cursor en Reloj 1 o Reloj 2:

- 1 Oprima \uparrow o \downarrow para seleccionar Reloj 1 o Reloj 2 y, después, oprima Enter .
- 2 Oprima \uparrow o \downarrow para introducir la hora y canal que prefiera y, después, oprima Enter .
- 3 Oprima MENU para salir del menú.

 Es preciso ajustar Hora Actual para poder utilizar Reloj 1 y Reloj 2.

 Es posible ajustar el Reloj en SI, NO o Ajuste. Una vez programado el reloj, podrá activarlo o desactivarlo sin necesidad de realizar los distintos ajustes.

Hora de Verano **SI:** Selecciónelo en primavera para compensar la hora de verano.
NO: Selecciónelo en otoño al final de la Hora de Verano.

 Al ejecutar Auto Programación, se borrarán todos los ajustes de Reloj 1 y Reloj 2.

 En caso de interrupción de alimentación, se borrarán los ajustes de Hora Actual, Reloj 1 y Reloj 2.

Uso del menú de Ajustes

Para acceder el menú de Ajustes, realice los siguientes pasos:





Caption Vision <i>Subtítulos</i>	Permite realizar la selección entre los tres modos de subtítulo (para programas que se emiten con subtítulos). Oprima \uparrow o \downarrow para seleccionar una de las siguientes opciones: NO: Desactiva Caption Vision. CC1, 2, 3, 4: Muestra el diálogo impreso y los efectos de sonido de un programa. TXT1, 2, 3, 4: Muestra información de la red/emisora. XDS (Servicio ampliado de datos): Muestra información sobre la emisora y el programa actual, si está disponible.
Etiqueta de Video <i>Nombre de equipos conectados</i>	Permite asignar nombre a los equipos de audio/video que haya conectado al televisor para poder identificarlos cuando se encuentre en el modo Desplegado. Con la ventana Etiqueta de Video abierta: 1 Oprima \uparrow o \downarrow para acceder a la entrada a la que desee asignar nombre y oprima Enter . 2 Oprima \uparrow o \downarrow para elegir un nombre y oprima Enter .
Rotación	Oprima \downarrow o \uparrow para corregir cualquier inclinación que se aprecie en la imagen entre -5 y +5. Oprima Enter para activarlo.
Lenguaje	Selecciónelo para mostrar todos los menús en el idioma que desee. Utilice los botones \uparrow o \downarrow , seleccione el idioma que desee y oprima Enter .
16:9 Realzado	Proporciona una resolución realzada de imagen para fuentes de pantalla panorámica como DVD (disponible solamente cuando el televisor se encuentra en el modo de Video).
Demostración	Selecciónelo para ver una demostración de los menús en pantalla.

Uso del menú Básico

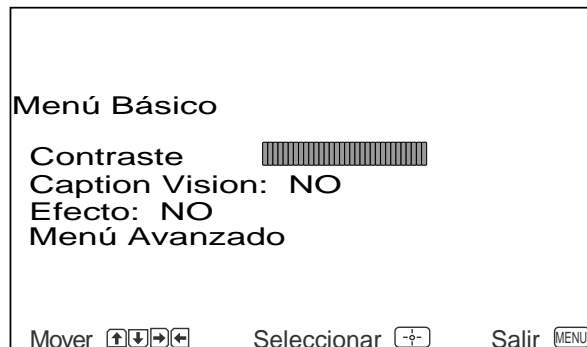
Para acceder el menú Básico, realice los siguientes pasos:









<p>Contraste <i>Contraste de imagen</i></p>	<p>Oprima ⇐ para disminuir el contraste de la imagen. Oprima ⇒ para aumentar el contraste de la imagen.</p>
<p>Caption Vision <i>Subtítulos</i></p>	<p>Permite realizar la selección entre los tres modos de subtítulo (para programas que se emiten con subtítulos). Oprima ⬆ o ⬇ para seleccionar una de las siguientes opciones: NO: Caption Vision no se activa. CC1, 2, 3, 4: Muestra el diálogo impreso y los efectos de sonido de un programa. TXT1, 2, 3, 4: Muestra información de la red/emisora. XDS (Servicio ampliado de datos): Muestra información sobre la emisora y el programa actual, si está disponible.</p>
<p>Efecto</p>	<p>Oprima ⬆ o ⬇ para seleccionar una de las siguientes opciones: NO: Recepción estereofónica o monofónica normal. SRS: Produce sonido tridimensional dinámico para señales de audio estéreo (sólo KV-29FV17 y KV-29FV17C). Simulado: Añade un efecto de sonido envolvente simulado en los programas monofónicos (sólo KV-29FV17 y KV-29FV17C). Surround: Simula el sonido con calidad de sala de cine para programas estéreo (sólo KV-29FS13 y KV-29FS13C).</p>
<p>Menú Avanzado</p>	<p>Selecciónelo para volver a los menús principales.</p>

 Si utiliza el botón  para cerrar el menú Básico, sólo aparecerá dicho menú al oprimir  de nuevo. Para tener acceso a otros menús, utilice ⬇ para seleccionar el menú Avanzado.

Información adicional

Programación del control remoto

Se puede utilizar el control remoto que se suministra para poner en funcionamiento tanto equipos de video Sony como equipos de otras marcas.

- 1 Oprima .
- 2 Oprima  o  (FUNCTION).
- 3 Utilice los botones - para introducir el número de código de la siguiente tabla.
- 4 Oprima .

Códigos de videocaseteras

Sony	301, 302, 303	JCPenney	309, 305, 304, 330, 314, 336, 337
Admiral (M.Ward)	327	JVC	314, 336, 337, 345, 346, 347
Aiwa	338, 344	Kenwood	314, 336, 332, 337
Audio Dynamic	314, 337	LXI (Sears)	332, 305, 330, 335, 338
Broksonic	319, 317	Magnavox	308, 309, 310
Canon	309, 308	Marantz	314, 336, 337
Citizen	332	Marta	332
Craig	302, 332	Memorex	309, 335
Criterion	315	Minolta	305, 304
Curtis Mathis	304, 338, 309	Mitsubishi/MGA	323, 324, 325, 326
Daewoo	341, 312, 309	Multitech	325, 338, 321
DBX	314, 336, 337	NEC	314, 336, 337
Dimensia	304	Olympic	309, 308
Emerson	319, 320, 316, 317, 318, 341	Optimus	327
Fisher	330, 335	Panasonic	308, 309, 306, 307
Funai	338	Pentax	305, 304
General Electric	329, 304, 309	Philco	308, 309
Go Video	322, 339, 340	Philips	308, 309, 310
Goldstar	332	Pioneer	308
Hitachi	306, 304, 305, 338	Quasar	308, 309, 306
Instant Replay	309, 308	RCA/PROSCAN	304, 305, 308, 309, 311, 312, 313, 310, 329

Códigos de videocaseteras

Realistic	309, 330, 328, 335, 324, 338
Sansui	314
Samsung	322, 313, 321
Sanyo	330, 335
Scott	312, 313, 321, 335, 323, 324, 325, 326
Sharp	327, 328
Shintom	315
Signature 2000 (M.Ward)	338, 327
SV2000	338
Sylvania	308, 309, 338, 310

Códigos de decodificadores

Hamlin/Regal	222, 223, 224, 225, 226
Jerrold/G. I.	201, 202, 203, 204, 205, 206, 207, 208, 218
Oak	227, 228, 229
Panasonic	219, 220, 221
Pioneer	214, 215
Scientific Atlanta	209, 210, 211
Tocom	216, 217
Zenith	212, 213

Códigos de reproductores de discos láser

Sony	701
Panasonic	704, 710
Pioneer	702

Códigos de DBS

DIRECTV	809
Echostar/Dish Network	810

Symphonic	338
Tashiro	332
Tatung	314, 336, 337
Teac	314, 336, 338, 337
Technics	309, 308
Toshiba	312, 311
Wards	327, 328, 335, 331, 332
Yamaha	314, 330, 336, 337
Zenith	331

Códigos de receptores de satélite

Sony	801
General Electric	802
Hitachi	805
Hughes	804
Panasonic	803
RCA/PROSCAN	802, 808
Toshiba	806, 807

Códigos de reproductores DVD









Sony	751
JVC	756
Mitsubishi	761
Onkyo	762
Oritron	759
Panasonic	753
Philips/Magnavox	757
Pioneer	752
RCA	755
Samsung/Hitachi	758
Toshiba	754
Zenith	760

 Si se indica más de un número de código, intente introducirlos uno por uno hasta que encuentre el correcto para su equipo.



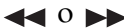





 Cuando quite las baterías, los números de código pueden regresar al ajuste de fábrica y será preciso volver a ajustarlos.

 En casos excepcionales, es posible que no se pueda emplear el equipo con el control remoto suministrado. En este caso, utilice el control remoto suministrado con el equipo.



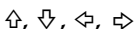

Empleo de una videocasetera

Oprima	Para
	Encender la videocasetera
	Seleccionar canales directamente
	Cambiar de canal
	Reproducir cintas de video
	Detener el funcionamiento
	Buscar hacia delante o atrás
	Introducir pausas
 (simultáneamente)	Grabar
	Cambiar entre las entradas de videocasetera y televisor

Empleo de un reproductor DVD

Oprima	Para
	Encender el reproductor DVD
	Seleccionar capítulos directamente
	Buscar capítulos hacia delante o atrás
	Reproducir un DVD
	Detener el funcionamiento
	Introducir pausas
	Desplazar el cursor por el menú
	Mostrar el menú DVD



Empleo de un reproductor de discos láser











Oprima	Para
VCR/DVD 	Encender el reproductor de discos láser
CH ⊕ ⊖	Buscar capítulos hacia delante o atrás
	Reproducir discos
	Detener el funcionamiento
	Introducir pausas

Solución de problemas

Si tiene algún problema con su televisor, consulte las sugerencias siguientes. Si el problema no se soluciona, póngase en contacto con su distribuidor Sony.

Ausencia de imagen y de sonido	<ul style="list-style-type: none"> <input type="checkbox"/> Asegúrese de que el cable de alimentación está enchufado. <input type="checkbox"/> Si la luz roja de la parte frontal del televisor parpadea durante más de unos minutos, desconecte y vuelva a conectar el cable de alimentación para restablecer el televisor. Si el problema continúa, llame al centro de asistencia técnica local. <input type="checkbox"/> Compruebe los ajustes TV/VIDEO: cuando vea la televisión, utilice el ajuste TV y, cuando emplee el equipo de video, utilice el ajuste VIDEO (página 16). <input type="checkbox"/> Asegúrese de que las baterías se han insertado en el control remoto correctamente (página 2). <input type="checkbox"/> Pruebe otro canal, ya que los problemas podrían proceder de la emisora.
Sin imagen o imagen defectuosa, buen sonido	<ul style="list-style-type: none"> <input type="checkbox"/> Ajuste Contraste en el menú de Video (página 23). <input type="checkbox"/> Ajuste Brillo en el menú de Video (página 23). <input type="checkbox"/> Compruebe las conexiones de antena y/o cable (página 3).
Buena imagen, sin sonido	<ul style="list-style-type: none"> <input type="checkbox"/> Oprima MUTING para que desaparezca MUTING de la pantalla (página 15). <input type="checkbox"/> Compruebe los ajustes de Audio. El televisor puede estar ajustado en Auto-SAP (página 25).
Sin color	<ul style="list-style-type: none"> <input type="checkbox"/> Ajuste Color en el menú de Video (página 23).
Sin señal	<ul style="list-style-type: none"> <input type="checkbox"/> Compruebe el ajuste Cable del menú de Ajuste de Canal (página 26). <input type="checkbox"/> Compruebe las conexiones de antena y/o cable (página 3). <input type="checkbox"/> Asegúrese de que el canal seleccionado emite actualmente.
Rayas o líneas con puntos	<ul style="list-style-type: none"> <input type="checkbox"/> Ajuste la antena. <input type="checkbox"/> Aleje el televisor de cualquier otro equipo electrónico. Algunos equipos electrónicos pueden crear ruido eléctrico que interfiera con la recepción de televisión.

Imágenes dobles o fantasma	<ul style="list-style-type: none"> <input type="checkbox"/> Compruebe la antena exterior o llame al proveedor del servicio de cable.
No puede recibir canales de banda alta (UHF) cuando utiliza una antena	<ul style="list-style-type: none"> <input type="checkbox"/> Asegúrese de que Cable está ajustado en la posición NO en el menú de Ajuste de Canal (página 26). <input type="checkbox"/> Utilice Auto Programación para añadir canales que no están en la memoria (página 17).
Parece que las emisoras por cable no funcionan	<ul style="list-style-type: none"> <input type="checkbox"/> Asegúrese de que Cable está ajustado en la posición SI en el menú de Ajuste de Canal (página 26). <input type="checkbox"/> Utilice Auto Programación para añadir canales que no están en la memoria (página 17).
El control remoto no funciona	<ul style="list-style-type: none"> <input type="checkbox"/> Las baterías podrían estar bajas. Sustitúyalas (página 2). <input type="checkbox"/> Aleje el televisor 1 metro aproximadamente de las luces fluorescentes.
Imposible cambiar de canal con el control remoto	<ul style="list-style-type: none"> <input type="checkbox"/> Asegúrese de que no ha cambiado accidentalmente el televisor del ajuste de canal 3 o 4 si utiliza otro dispositivo para cambiar de canal. <input type="checkbox"/> Si utiliza otro dispositivo para controlar los canales, asegúrese de oprimir el botón FUNCTION correspondiente a dicho dispositivo. Por ejemplo, si utiliza la videocasetera para controlar los canales, asegúrese de oprimir los botones VCR/DVD FUNCTION (página 15).
Es necesario limpiar el televisor	<ul style="list-style-type: none"> <input type="checkbox"/> Limpie el TV con un paño suave y seco. Nunca emplee disolventes, como diluyente de pintura o bencina, ya que pueden dañar el acabado exterior.
No puede acceder a otros menús mientras utiliza el menú Básico	<ul style="list-style-type: none"> <input type="checkbox"/> Si utiliza el botón  para cerrar el menú Básico, sólo aparecerá dicho menú al oprimir  de nuevo. Para tener acceso a otros menús, utilice el botón  para seleccionar el menú Avanzado (página 31).
El control remoto no funciona en el modo PIP	<ul style="list-style-type: none"> <input type="checkbox"/> Oprima el botón TV FUNCTION. Es posible que haya oprimido accidentalmente el botón VCR/DVD FUNCTION, que cambia los botones PIP al modo de videocasetera (página 15).

-
- | | |
|--|--|
| No aparece la imagen de ventana o aparece estática | <ul style="list-style-type: none">❑ Asegúrese de que la imagen de ventana está ajustada en una fuente de video/canal en el que se emita algún programa.❑ Es posible que haya sintonizado una entrada de video a la que no hay nada conectado. Recorra las entradas de video utilizando el botón PIP TV/VIDEO amarillo con punto rojo (página 18).❑ PIP no está ajustado para recibir la señal de la entrada AUX. Si ha conectado una videocasetera, reproductor DVD o receptor de satélite a la entrada AUX del televisor, la imagen no aparecerá en la ventana pequeña. |
| Aparece el mismo programa en la imagen de ventana y en la principal | <ul style="list-style-type: none">❑ Es posible que ambas estén ajustadas en el mismo canal. Cambie de canal en la imagen principal o en la de ventana (páginas 18-19).❑ Es posible que el televisor esté ajustado para seleccionar todos los canales mediante un decodificador. El decodificador sólo decodificará una señal cada vez, por lo que no es posible utilizar la función PIP. Si es posible, conecte un cable directo a la toma VHF/UHF del televisor. Esto sólo funcionará si el sistema de cable proporciona señales no codificadas (página 5). |
| Control remoto perdido | <ul style="list-style-type: none">❑ Puede utilizar los controles del panel frontal de audio/video para acceder a los menús. Oprima  para abrir el menú. Utilice los botones  o  del panel frontal de audio/video en lugar de los botones  o  del control remoto. Utilice el botón  del panel frontal de audio/video en lugar de los botones , , y  del control remoto. Oprima  de nuevo cuando haya completado el ajuste. Póngase en contacto con el distribuidor Sony más próximo para solicitar un control remoto. |
-

Si usted necesita asistencia adicional, llame al número de apoyo técnico de Sony correspondiente a su país. Uno de los profesionales de apoyo técnico de Sony estará encantado de asistirle.

Especificaciones

Para todos los modelos (excepto donde se indique)

Sistema de televisión	Estándar americano de TV/NTSC
Cobertura de canales	VHF: 2-13/UHF: 14-69/Cable: 1-125
Antena	Terminal de antena externa de 75 ohm para VHF/UHF
Tubo de imagen	FD Trinitron®
Requisitos del suministro eléctrico	ca 120 V 60 Hz (KV-29FS13, KV-29FV17) ca 220 V 50 Hz (KV-29FS13C, KV-29FV17C)
Accesorios suministrados	Baterías tamaño AA (R6) (2) Control remoto RM-Y180 (1) (KV-29FS13, KV-29FS13C) RM-Y181 (1) (KV-29FV17, KV-29FV17C)
Accesorios opcionales	Cables de conexión VMC-810S/820S, VMC-720M, YC-YC-15V/30V, RK74A Mezclador de U/V EAC-66 Soporte para televisor: SU-27FD4
KV-29FS13, KV-29FS13C	
Tamaño de pantalla	Tamaño de pantalla visible medida diagonalmente: 679 mm (27 pulgadas) Tamaño de pantalla real medida diagonalmente: 724 mm (29 pulgadas)
Entradas/Salidas	3 video, 3 audio 1 S VIDEO 1 salida de audio 1 entrada RF 1 Y, P _B , P _R , 1 audio
Salida de la bocina	10 W × 2
Consumo de energía	175 W en uso 1 W en espera
Dimensiones (An/Al/Prf)	700 × 632 × 512 mm (27 ⁵ / ₈ × 25 × 20 ¹ / ₄ pulgadas)
Peso	47 kg (103 lbs. 10 oz.)

KV-29FV17, KV-29FV17C

Tamaño de pantalla	Tamaño de pantalla visible medida diagonalmente: 679 mm(27 pulgadas) Tamaño de pantalla real medida diagonalmente: 724 mm (29 pulgadas)
Entradas/Salidas	3 video, 3 audio 1 S VIDEO 1 salida de audio 1 salida de monitor 2 entradas RF 1 Y, P _B , P _R , 1 audio
Salida de la bocina	15 W × 2
Consumo de energía	220 W en uso (KV-29FV17) 210 W en uso (KV-29FV17C) 1 W en espera
Dimensiones (An/Al/Prf)	762 × 604 × 519 mm (30 × 23 ⁷ / ₈ × 20 ¹ / ₂ pulgadas)
Peso	49 kg (108 lbs.)

El diseño y las especificaciones están sujetos a cambios sin previo aviso.

Índice alfabético

16:9 Realzado 30

A

Agudos 24
Auto Programación 17, 27
Auto-SAP 25
Auto Volumen 24

B

Balance 24
Bloquear 28
Bocinas 25
Brillo 23

C

Cable 26
Calidez 23
Canal Favorito 26
Caption Vision 30, 31
Color 23
Conexiones
 Cable y antena 3
 Decodificador y cable 5
 Decodificador y televisor 4
 Conexión de una cámara de video 11
 Conexión de un reproductor DVD 11
 Conexión de un sistema de audio 12
 Conexión de dos videocaseteras para edición de cintas 13
 Televisor y videocasetera 6
 Televisor y receptor de satélite 9
 Televisor, receptor de satélite y videocasetera 10
 Televisor, videocasetera y decodificador 7
Contraste 23, 31
Control remoto 14

D

Demostración 30
Desbloquear 28
DISPLAY 16

E

Efecto
 NO 24, 31
 Simulado 24, 31
 SRS 24, 31
 Surround 24, 31
Especificaciones 39
Estéreo 25
Etiqueta de Video 30

F

Fijar Canal 27
Funciones del televisor 1

G

Graves 24

H

Hora Actual 29
Hora de Verano 29







I

Imagen en imagen (PIP) 18
Instalación de las baterías 2

L

Lenguaje 30

M

Menús
 Audio  24
 Básico  31
 Ajuste de Canal  26
 Paterno  28
 Ajustes  30
 Reloj  29
 Video  23

Modo

Vívido 23

Estándar 23

Deportes 23

Película 23

Mono 25

MTS

Auto-SAP 25

Mono 25

Estéreo 25

MV 23

N

Nitidez 23

Nombre de Canal 27

O

Omitir/Añadir Canal 27

P

Programación del control
remoto 32

R

Reloj 1 y Reloj 2 29

Rotación 30

S

Salida 25

SLEEP 15

Solución de problemas 36

T

Tinte 23

SONY[®]

4-081-739-41



FD Trinitron
WEGA

Televisor Trinitron[®] A Color

Manual de Instrucciones

Lea este manual antes de operar el producto.

KV-34FS13A
KV-34FS13C
KV-34FS17

ADVERTENCIA

Para evitar el riesgo de incendio o descarga eléctrica, no exponga el televisor a la lluvia o humedad.



Este símbolo señala al usuario la presencia de voltaje peligroso sin aislamiento en el interior del aparato, y de tal intensidad que podría presentar riesgo de descarga eléctrica.



Este símbolo indica al usuario que el manual que acompaña a este aparato contiene instrucciones importantes referentes a su funcionamiento y mantenimiento.

Nota para el técnico que instale el sistema CATV

El Artículo 820-40 del NEC contiene normas para la puesta a tierra y, en particular, dispone que la tierra del cable debe conectarse al sistema de tierra del edificio en el punto más próximo que sea factible a la entrada del cable.

PRECAUCIONES DE SEGURIDAD

- Opere el televisor únicamente con corriente alterna de 120-220 V
- La clavija está diseñada, por motivos de seguridad, para entrar a la tomacorriente en una sola posición. Si Ud. no puede meter la clavija completamente a la tomacorriente, consulte con su proveedor.
- Si algún líquido u objeto cae dentro del televisor, desconéctelo inmediatamente y llévalo al personal de servicio técnico especializado para que lo revisen antes de volver a utilizarlo.

PRECAUCIÓN

Al usar videojuegos, computadoras y productos similares con el televisor, mantenga los ajustes de brillo y contraste a un nivel moderado. Si una imagen inmóvil permanece en la pantalla durante un periodo prolongado con elevada intensidad de brillo o contraste, la imagen podría quedar grabada en la pantalla en forma permanente. Igualmente, ver continuamente el mismo canal de televisión podría dejar grabada en la pantalla el logotipo de la emisora. La garantía no cubre este tipo de anomalías, ya que se deben al mal uso del aparato.



Para evitar el riesgo de descarga eléctrica, no emplee esta clavija polarizada con un cable prolongador, receptáculo u otra tomacorriente, a menos que las cuchillas puedan insertarse completamente a fin de que no queden al descubierto.



Cualquier cambio o modificación que no se detalla expresamente en el presente manual podría invalidar su autorización para emplear este aparato.

NOTIFICACIÓN

Este aparato ha sido debidamente probado, comprobándose que cumple con los límites impuestos a dispositivos digitales Clase B de acuerdo con la Sección 15 de las normas de la FCC. Estos límites se establecieron para ofrecer protección razonable contra interferencias perjudiciales en las instalaciones residenciales. Este aparato genera, usa y puede emitir energía radioeléctrica. De no instalarse y utilizarse de acuerdo con las instrucciones correspondientes podría producir interferencias perjudiciales en las radiocomunicaciones. No obstante, no puede garantizarse que no se produzcan estas interferencias en una instalación determinada. Si este aparato llega a interferir en la recepción por radio o televisión, lo que podrá comprobarse encendiendo y apagando el aparato, se recomienda al usuario intentar corregir la interferencia mediante una o más de las siguientes medidas:

- Reoriente o cambie de lugar las antenas receptoras.
- Aumente la distancia que separa este aparato y el receptor afectado.
- Enchufe el aparato en una toma de corriente de un circuito distinto al que esté enchufado el receptor afectado.
- Consulte con el distribuidor o solicite los servicios de un técnico capacitado en radio y televisión.

Protección del televisor

- Para evitar el sobrecalentamiento interno, no tape las rejillas de ventilación.
- No instale el televisor en un lugar caliente o húmedo, ni donde quede expuesto a cantidades excesivas de polvo o vibraciones mecánicas.

Nota sobre la función "Caption Vision"

Este televisor permite ver subtítulos, en cumplimiento con lo dispuesto en el inciso 15,119 de las normas de la Comisión Federal de Comunicaciones (FCC) de EE.UU.

El empleo de este televisor para fines que no sean la recepción privada de programas transmitidos por UHF, VHF o cable, destinados al uso del público en general, podría requerir autorización de la emisora o compañía de cable del propietario del programa o de ambos.

Registro de propiedad

El modelo y el número de serie están situados en la portada de este manual y en la parte posterior del televisor.

Marcas comerciales y copyrights

ENERGY STAR® es marca registrada.



Como socio de ENERGY STAR®, Sony ha determinado que este producto o este modelo de producto cumple con las pautas ENERGY STAR® para eficiencia energética.

Normas de seguridad importantes

Para su protección, lea detenidamente estas instrucciones, y guarde este manual para futuras referencias. Lea cuidadosamente todas las advertencias y precauciones, y siga las instrucciones inscritas en el televisor o descritas en el manual de instrucciones o de reparación.

ADVERTENCIA

Para protegerse contra daños personales, siga las precauciones de seguridad básicas durante la instalación, la utilización y el mantenimiento del televisor indicadas a continuación.

Utilización

Fuentes de alimentación

Este aparato solamente deberá alimentarse con el tipo de fuente de alimentación indicado en la etiqueta de serie/modelo. Si no está seguro sobre el tipo de red eléctrica de su hogar, consulte a su proveedor o a la compañía de suministro eléctrico local. Con respecto a los aparatos diseñados para utilizarse con baterías, consulte el manual de instrucciones.

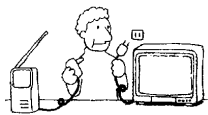

Para un televisor con clavija del cable de alimentación polarizado

Esta clavija solamente encajará en la toma de alimentación de una sola forma. Ésta es una medida de seguridad. Si no es capaz de insertar completamente la clavija en la toma de alimentación, pruebe invirtiéndola. Si la clavija sigue sin poder insertarse, póngase en contacto con un electricista para que le instale una toma adecuada. No elimine la finalidad de seguridad del enchufe polarizado insertándolo con fuerza.

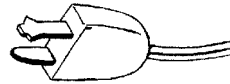

Conexión a tierra o polarización

Este aparato dispone de una clavija del cable de alimentación polarizado (una cuchilla de la clavija es más ancha que la otra), o con tres terminales (el tercero es para puesta a tierra). Siga las instrucciones indicadas a continuación:

Advertencia alternativa

Para un televisor con clavija de tres terminales con conexión a tierra

Esta clavija solamente podrá insertarse en una toma de la red con conexión a tierra. Ésta es una medida de seguridad. Si no es capaz de insertar completamente la clavija en la toma de alimentación, póngase en contacto con un electricista para que le instale una toma adecuada. No elimine la finalidad de seguridad de la clavija de 3 terminales insertándolo con fuerza.

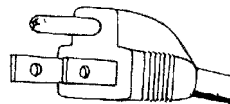

Sobrecarga

No sobrecargue las tomas de alimentación, los cables prolongadores ni tomacorrientes de derivación sobrepasando su capacidad, porque esto podría resultar en incendios o cortocircuitos. Apague siempre el aparato cuando no lo utilice. Cuando vaya a dejar el aparato sin usar durante mucho tiempo, desconéctelo de la alimentación como protección contra la posibilidad de un mal funcionamiento interno que pudiese provocar el peligro de incendio.

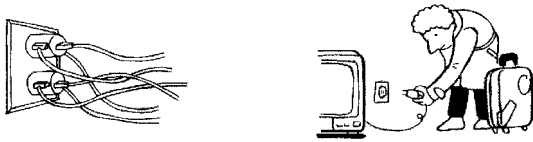

No desconecte la antena ni el cable de alimentación durante tormentas fuertes. Podría recibir una descarga eléctrica mientras agarra el cable, causándole graves daños. Apague el televisor y espere a que las condiciones meteorológicas mejoren.

Introducción de objetos y líquidos

No introduzca nunca objetos de ningún tipo a través de las ranuras del gabinete, ya que podrían tocar puntos de tensión peligrosa o cortocircuitar partes, lo que podrían resultar en incendios o descargas eléctricas. No vierta nunca ningún tipo de líquido sobre el aparato.



Accesorios

No utilice nunca ningún accesorio no recomendado por el fabricante, ya que podrían ser peligrosos.

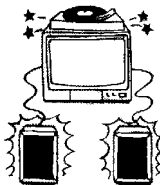

No coloque objetos, especialmente los pesados, sobre el aparato. El objeto puede caerse del televisor, causándole heridas.

Limpieza

Antes de limpiar el televisor, desconéctelo de la alimentación. No utilice limpiadores líquidos ni aerosoles. Para limpiar el exterior del aparato, emplee un paño ligeramente humedecido en agua.

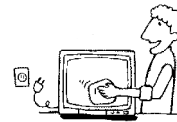

Si un televisor en funcionamiento emite crujidos o detonaciones continuos o frecuentes, desconéctelo y consulte a su proveedor o a un radiotécnico. Es normal que algunos televisores produzcan estos ruidos, especialmente al conectar o desconectar su alimentación.

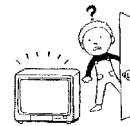

Instalación

Son precisas dos o más personas para levantar o mover el aparato. El aparato es pesado y la superficie inferior es plana. Si el aparato lo mueve una sola persona o si se maneja en lugares inestables, pueden producirse daños graves. Instale el aparato sobre una superficie estable y nivelada.

Agua y humedad

No utilice aparatos que requieran de alimentación eléctrica cerca del agua, por ejemplo, cerca de una bañera, un lavabo, un fregadero o una lavadora en un sótano húmedo, ni cerca de una piscina, etc.

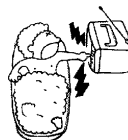

Colocación

No coloque el aparato sobre una mesita con ruedas, un pedestal, un trípode, una abrazadera, una mesa o un estante inestable. El televisor podría caerse causando daños serios a niños, adultos, y al propio televisor. Utilice solamente la mesita con ruedas o soporte recomendado por el fabricante para el modelo específico de TV. El montaje del producto se debe hacer según las instrucciones del fabricante y usted debe usar un accesorio de montaje recomendado por el fabricante. La combinación de un televisor y un mueble con ruedas deberá moverse con cuidado. Las paradas repentinas, la fuerza excesiva y las superficies desiguales podrían hacer que se cayese tal combinación.

Desconecte todos los cables del aparato antes de moverlo.



No permita que niños ni mascotas se suban al aparato ni que lo empujen. El televisor podría caerse, causando daños graves.

Ventilación

Las ranuras y aberturas del gabinete y de la parte posterior o inferior son para permitir la ventilación necesaria. Para asegurar la operación fiable del televisor, y protegerlo contra el sobrecalentamiento, estas ranuras y aberturas no deberán cubrirse ni bloquearse nunca.

- **No bloquear nunca las ranuras ni aberturas con paños ni otros materiales.**

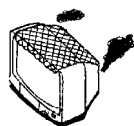

- **No bloquee nunca las ranuras ni aberturas colocando el televisor sobre una cama, sofá, alfombra u otras superficies similares.**

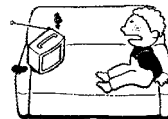

- **No coloque nunca el televisor en un lugar cerrado, como en un librero o un mueble empotrado, a menos que esté adecuadamente ventilado.**

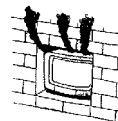

- **No coloque el televisor cerca ni sobre un radiador o una salida de aire caliente, ni expuesto a la luz solar directa.**



Protección del cable de alimentación

No permita que ningún objeto quede sobre el cable de alimentación, ni coloque el televisor donde el cable pueda quedar sometido a desgaste o presión.

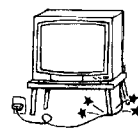

Conexión a tierra o polarización

Es posible que este aparato venga equipado con un enchufe de corriente alterna polarizado (un enchufe que tiene una pata más ancha que la otra). Este enchufe calza en el tomacorriente de una manera solamente. Esto es una función de seguridad. Si usted no puede insertar el enchufe por completo en el tomacorriente, trate de darlo vuelta. Si todavía el enchufe no entra, comuníquese con un electricista para que cambie el tomacorriente obsoleto. No rechace el propósito de seguridad del enchufe polarizado.

Antenas

Conexión a tierra de la antena exterior

Cuando instale una antena exterior, tenga en cuenta las precauciones siguientes. Un sistema de antena exterior no deberá colocarse cerca de líneas de alta tensión ni otros circuitos de iluminación o alimentación, ni donde pueda entrar en contacto con tales líneas o circuitos.

CUANDO INSTALE UN SISTEMA DE ANTENA EXTERIOR, TENGA EXTREMADO CUIDADO PARA EVITAR QUE ENTRE EN CONTACTO CON TALES LÍNEAS DE ALIMENTACIÓN O CIRCUITOS, YA QUE TAL CONTACTO PODRÍA RESULTAR INVARIABLEMENTE FATAL.

Cerciórese de que el sistema de antena esté puesto a tierra a fin de que proporcione cierta protección contra sobretensiones y cargas estáticas. La Sección 810 del Código Eléctrico Nacional (NEC) de EE.UU., y la Sección 54 del Código Eléctrico Canadiense ofrecen información con respecto a la puesta a tierra adecuada de una unidad de descarga de antena, el tamaño de los conductores de conexión a tierra, la ubicación de la unidad de descarga de antena, la conexión a los electrodos de conexión a tierra, y los requisitos de tales electrodos.

Conexión a tierra de la antena de acuerdo con el Código Eléctrico Nacional

Con respecto a la conexión a tierra de la antena, consulte la sección 54-300 del Código Eléctrico Canadiense.

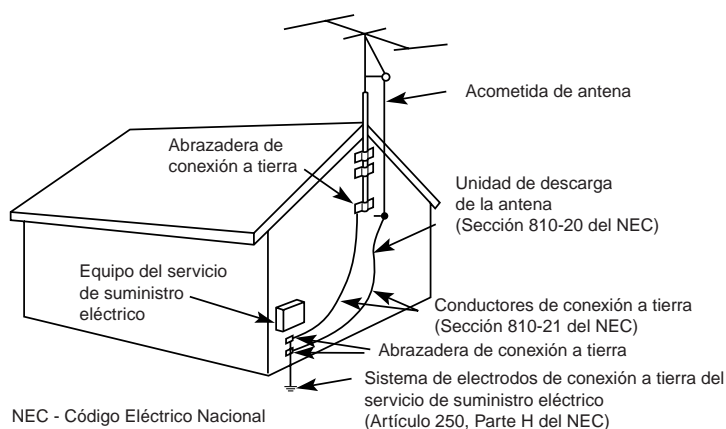

En caso de descarga eléctrica

Para evitar daños al televisor debido a una descarga eléctrica o a una sobretensión de corriente durante una tormenta, o cuando no se encuentre en uso por largos periodos de tiempo, desconecte el cable a la toma de corriente de la pared y desconecte la antena. Esto impedirá que el receptor se dañe.

Mantenimiento

Daños que requieren reparación

Desconecte el televisor de la toma de alimentación y solicite los servicios de personal de reparación calificado en las condiciones siguientes:

- Cuando el cable o la clavija de alimentación esté dañado.

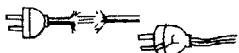

- Si dentro del televisor se ha derramado líquido o se cayeron objetos adentro del producto.

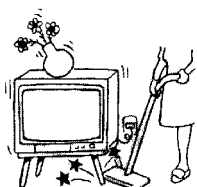

- Si el televisor ha estado expuesto a la lluvia o al agua.



- Si el televisor ha recibido un golpe fuerte al caer, o se daña el gabinete.

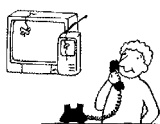

- Si el televisor no funciona normalmente al seguir las instrucciones de operación. Ajuste solamente los controles especificados en el manual de instrucciones. El ajuste inadecuado de otros controles podría resultar en daños que podrían requerir la intervención costosa de un técnico calificado a fin de devolver el televisor a su funcionamiento normal.



- Cuando el rendimiento del televisor haya cambiado notablemente, significará que es necesario repararlo.

Reparación

No intente reparar por sí mismo el aparato, ya que al abrir el gabinete se vería expuesto a tensiones peligrosas y otros riesgos. Solicite los servicios de personal de reparación calificado.



Piezas de reemplazo

Cuando se haya requerido el reemplazo de piezas, solicite al técnico de reparación un certificado por escrito de que ha utilizado las piezas de repuesto con las mismas características que las originales, especificadas por el fabricante. La sustitución no autorizada de piezas podría resultar en incendios, descargas eléctricas, u otros peligros.

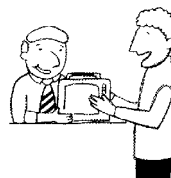

Comprobación de seguridad

Después de haber finalizado cualquier servicio de mantenimiento o reparación, solicite al técnico de reparación que realice y certifique las comprobaciones de seguridad rutinarias (como especifica el fabricante) para determinar si el televisor se encuentra en condiciones de funcionar con seguridad. Cuando finalice la vida útil del televisor, el deshacerse inadecuadamente de él podría provocar la implosión del tubo de imagen. Solicite este servicio a un técnico calificado.



Índice

Introducción

Funciones del televisor Trinitron® a color	1
Baterías para el control remoto	2
Uso del botón de MAIN POWER (botón de alimentación principal).....	2
Acerca de este manual	2







Conexión del televisor

Conexiones básicas.....	3
Conexiones de decodificador	4
Conexión de equipo adicional.....	6

Uso del control remoto y las funciones básicas

Uso del control remoto	15
Programación automática del televisor	17
Uso de Imagen en imagen (PIP).....	18
Acceso rápido a los menús.....	20

Uso de los menús

Para acceder a un menú	22
Uso del menú de Video 	23
Uso del menú de Audio 	24
Uso del menú de Ajuste de Canal 	26
Uso del menú Paterno 	28
Uso del menú de Reloj 	29
Uso del menú de Ajustes 	30
Uso del menú Básico 	31

Información adicional

Programación del control remoto	32
Solución de problemas	36
Especificaciones	39

Índice alfabético	41
--------------------------------	----

Introducción

Gracias por haber comprado el televisor Trinitron® a color de Sony. Antes de utilizar este manual, verifique el número de modelo localizado en la parte posterior del televisor o en la portada de este manual.

Funciones del televisor Trinitron® a color

A continuación se enumeran las características del televisor:

- ❑ **CRT PLANO** — Nueva pantalla tecnológicamente avanzada para obtener una óptima calidad de imagen.
- ❑ **Control Paterno** — Herramienta diseñada para que los padres puedan controlar el acceso de los niños al televisor mediante el establecimiento de límites de utilización.
- ❑ **Canal Favorito** — Acceso instantáneo a los canales preferidos con sólo tocar un botón.
- ❑ **Imagen en imagen (PIP)** — Permite visualizar dos canales simultáneamente (sólo KV-34FS17).
- ❑ **Control remoto universal** — Programe su control remoto para utilizar el decodificador, la videocasetera, el receptor de satélite digital o el reproductor DVD conectado.
- ❑ **Energy Star®** — Símbolo reconocido de eficiencia energética.
- ❑ **S VIDEO** — Entrada de video que ofrece una calidad de imagen mejorada.
- ❑ **MTS directo** — Proporciona acceso directo para cambiar el sonido multicanal del televisor: Estéreo, Mono o Auto-SAP (segundo programa de sonido), con sólo tocar un botón.
- ❑ **Menús bilingües** — Elija entre los menús Inglés o Español.
- ❑ **Controles del panel frontal** — Proporcionan acceso a los menús en pantalla sin necesidad de utilizar control remoto.
- ❑ **Entradas A/V frontales** — Conexión rápida para videojuegos, cámaras de video o equipo estéreo/mono.

Baterías para el control remoto

Inserte dos baterías tamaño AA (R6) (incluidas con el televisor) en el control remoto como se indica en la siguiente ilustración.

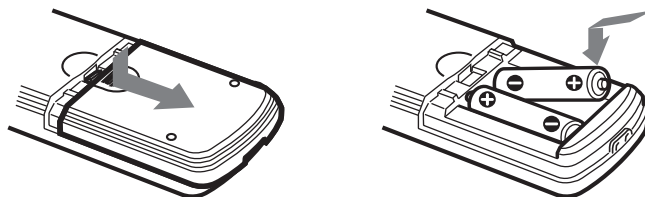

- 📌 En condiciones normales, las baterías durarán un máximo de seis meses. Si el control remoto no funciona correctamente, es posible que las baterías estén agotadas.
- 📌 Cuando el control remoto no vaya a utilizarse durante un periodo prolongado, quite las baterías para evitar que fugas de las mismas dañen su control remoto.
- 📌 Su control remoto puede programarse para hacer funcionar la mayoría de los equipos de video (consulte la página 32).

Uso del botón de MAIN POWER (botón de alimentación principal)

Sólo para el modelo KV-34FS13A

Antes de encender su televisor utilizando su control remoto, necesita presionar el botón  , localizado en la parte frontal de su televisor.

Acerca de este manual

En este manual se proporcionan las instrucciones necesarias para que disfrute de su nuevo televisor. Asimismo, se indica cómo conectar el televisor a una antena o cable, decodificador, videocasetera, reproductor DVD, receptor de satélite, sistema estereofónico o cámara de video. Una vez realizada la conexión, siga las instrucciones y utilice el control remoto para acceder a los menús en pantalla.

Conexión del televisor

Lea este capítulo antes de configurar el televisor por primera vez. En esta sección se incluyen las conexiones básicas, así como la conexión de cualquier otro equipo.

Conexiones básicas

Televisor con antena interior o exterior, o cable CATV

Dependiendo del cable disponible, elija una de las conexiones siguientes:

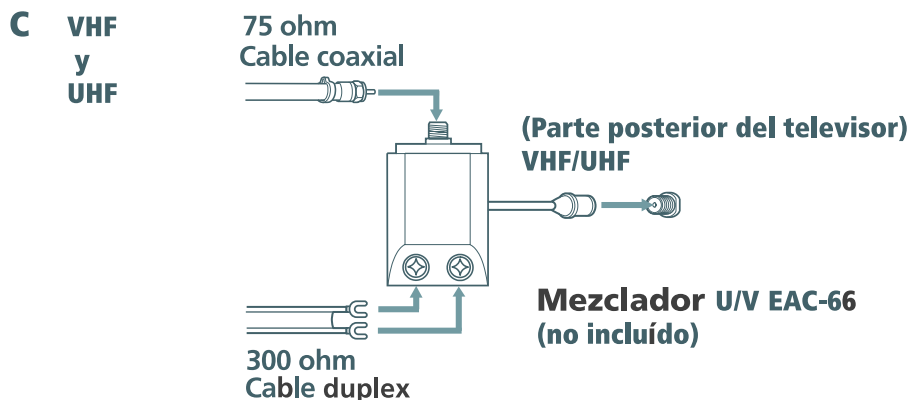
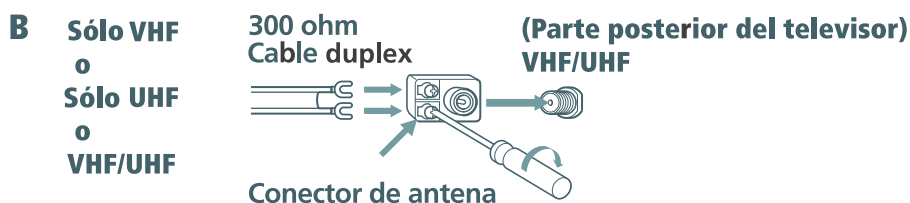
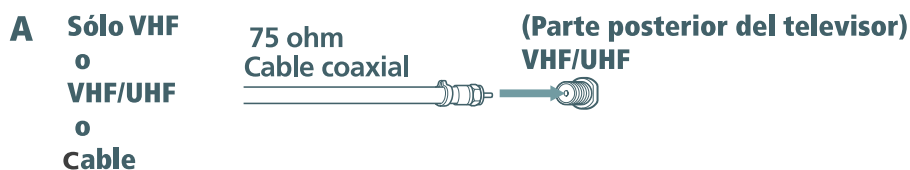

 Si realiza la conexión a una antena interior o exterior, es posible que necesite ajustar la orientación de la antena para obtener el mejor nivel de recepción.

Conexiones de decodificador

Algunos sistemas de televisión por cable usan señales deformadas o codificadas que requieren un decodificador para poder ver todos los canales. Si se suscribe a dicho tipo de servicio de cable, utilice esta conexión. Las señales codificadas que recibe el televisor mediante el decodificador no pueden visualizarse en PIP. Si algunos canales están codificados, considere el uso de la conexión de decodificador y cable (consulte la página 5).

Decodificador y televisor

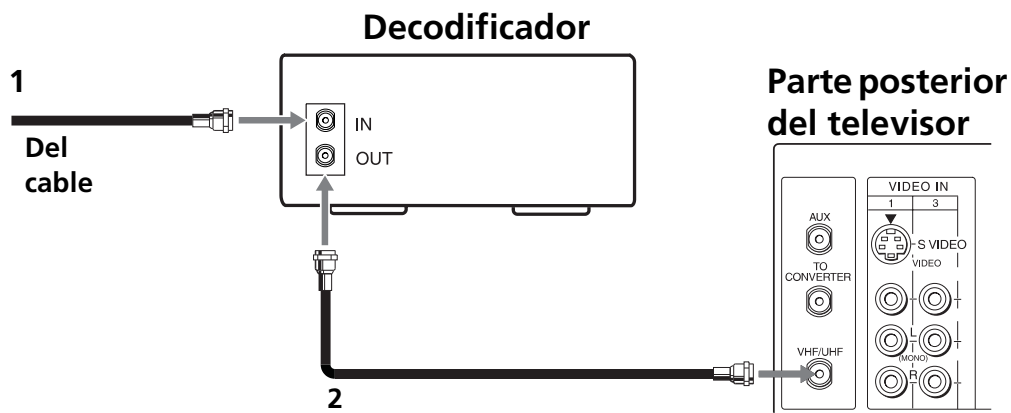

- 1** Conecte el cable coaxial del servicio de cable a la entrada IN de su decodificador.
- 2** Empleando un cable coaxial (no incluido), conecte la salida OUT de su decodificador a la entrada VHF/UHF de su televisor.

 Si va a hacer la selección de todos los canales a través de su decodificador, debe considerar la posibilidad de usar la función Fijar Canal ajustando el televisor en el canal 3 o 4 (consulte la página 27).

Decodificador y cable



Utilice esta conexión si se suscribe a un sistema de cable que codifique algunos canales (canales de pago), pero no todos. Esta configuración permite utilizar el control remoto para:

- a) cambiar de canal mediante el decodificador cuando se recibe una señal codificada, y
- b) cambiar de canal mediante el televisor.

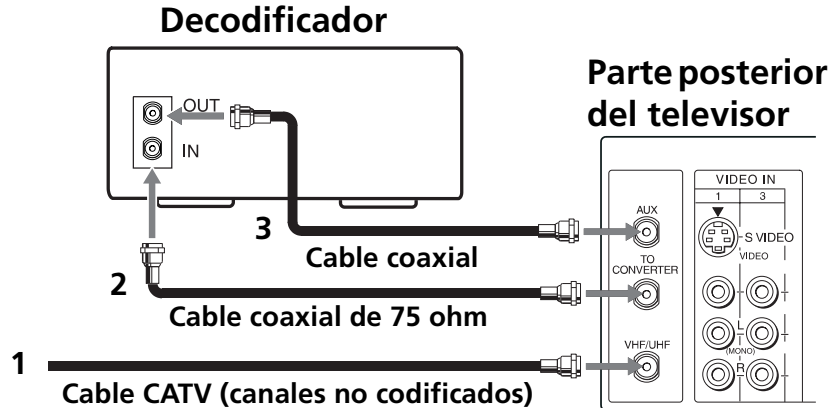
Esta conexión permite también utilizar la función PIP cuando se visualizan canales no codificados que el televisor recibe directamente del cable. Las señales codificadas transmitidas mediante el decodificador no pueden visualizarse en PIP. Para obtener más información sobre la función PIP, (consulte la página 18).



- 1** Conecte el cable coaxial de su servicio de cable a la entrada VHF/UHF de su televisor.
- 2** Empleando un cable coaxial (no incluido), conecte la entrada IN de su decodificador a la entrada TO CONVERTER de su televisor.
- 3** Empleando un cable coaxial (no incluido), conecte la salida OUT de su decodificador a la entrada AUX de su televisor.

 Al oprimir el botón  del control remoto, las entradas de decodificador y de cable directo cambian.

 Su control remoto Sony puede programarse para hacer funcionar su decodificador (consulte la página 32).

 Con el fin de utilizar el decodificador para cambiar de canal, ajuste el televisor en el canal 3 o 4. El ajuste de la función Fijar Canal garantiza que los canales no cambien accidentalmente utilizando el televisor (consulte la página 27).

Conexión de equipo adicional

Televisor y videocasetera

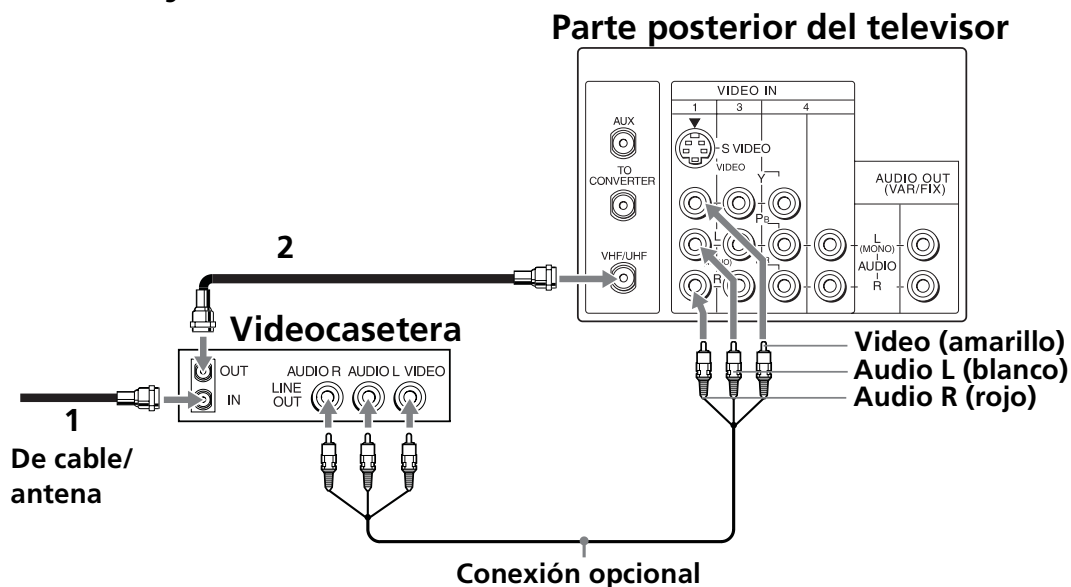

Para ver programas de video desde la videocasetera, sintonice el televisor con el canal 3 o 4 (como esté ajustado en la parte posterior de la videocasetera).

- 1 Conecte el cable coaxial de la antena del televisor o del servicio de cable a la entrada IN de su videocasetera.
- 2 Empleando un cable coaxial (no incluido), conecte la salida OUT de su videocasetera a la entrada VHF/UHF de su televisor.

Conexión opcional

Si la videocasetera está equipada con salidas de video, puede obtener mejor calidad de imagen conectando cables de Audio/Video (no incluidos) de las salidas AUDIO y VIDEO OUT de su videocasetera a las entradas AUDIO/VIDEO IN de su televisor.

Para obtener una calidad de imagen óptima, utilice S VIDEO en lugar del cable de Audio/Video amarillo. Puesto que S VIDEO no proporciona sonido, es preciso conectar los cables de audio.

Puede utilizar el botón para cambiar entre las entradas de VHF/UHF y VIDEO.

Televisor, videocasetera y decodificador

Utilice esta conexión si se suscribe a un sistema de cable que codifique algunos canales (canales de pago), pero no todos. Esta configuración permite utilizar el control remoto para:

- a) cambiar de canal mediante el decodificador o la videocasetera cuando se recibe una señal codificada, y
- b) cambiar de canal mediante el televisor.

Esta conexión permite también utilizar la función PIP cuando se visualizan canales no codificados que el televisor recibe directamente del cable. Las señales codificadas transmitidas mediante el decodificador no pueden visualizarse en PIP. Para obtener más información sobre la función PIP, (consulte la página 18).

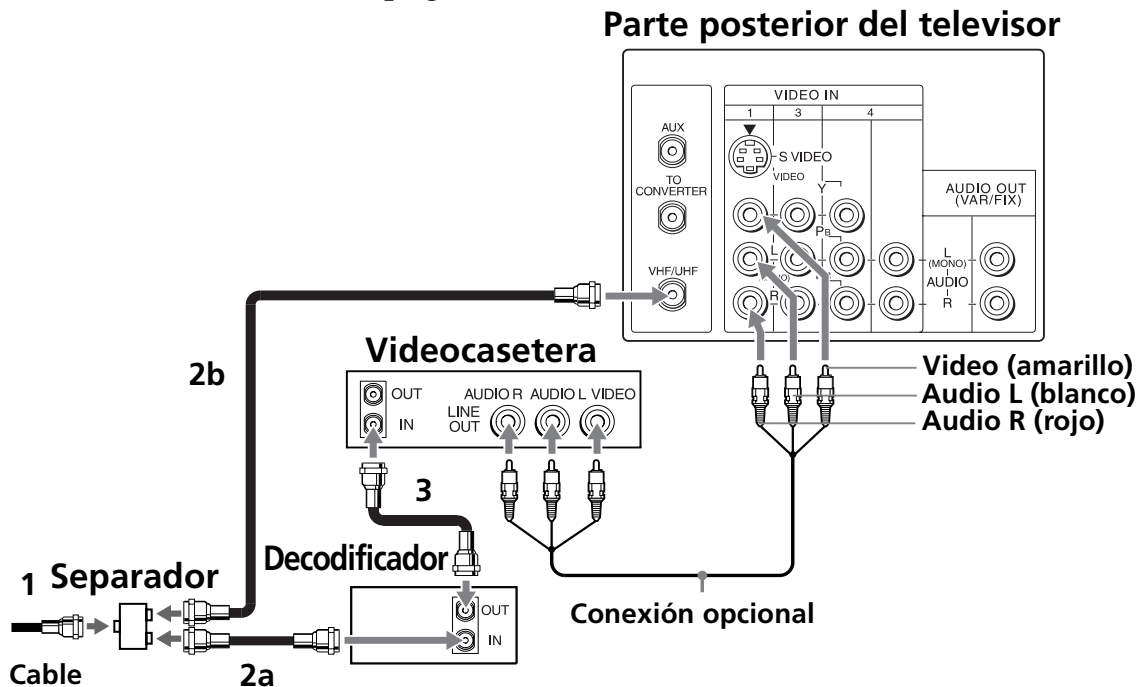



- 1** Conecte la toma de entrada única del separador a la conexión de cable entrante.
- 2** Con un cable coaxial (no incluido), conecte las dos tomas de salida del separador a:
 - a) la entrada IN del decodificador, y
 - b) la entrada VHF/UHF del televisor.
- 3** Empleando un cable coaxial (no incluido), conecte la salida OUT de su decodificador a la entrada IN de su videocasetera.

(continúa)

-  Si va a hacer la selección de todos los canales a través de su decodificador, debe considerar la posibilidad de usar la función Fijar Canal ajustando el televisor en el canal 3 o 4 (consulte la página 27).

Conexión opcional

Si la videocasetera está equipada con salidas de video, puede obtener mejor calidad de imagen conectando cables de Audio/Video (no incluidos) de las salidas AUDIO y VIDEO OUT de su videocasetera a las entradas AUDIO/VIDEO IN de su televisor.

-  Para obtener una calidad de imagen óptima, utilice S VIDEO en lugar del cable de Audio/Video amarillo. Puesto que S VIDEO no proporciona sonido, es preciso conectar los cables de audio.
-  Puede utilizar el botón  para cambiar entre las entradas de VHF/UHF y VIDEO.

Televisor y receptor de satélite

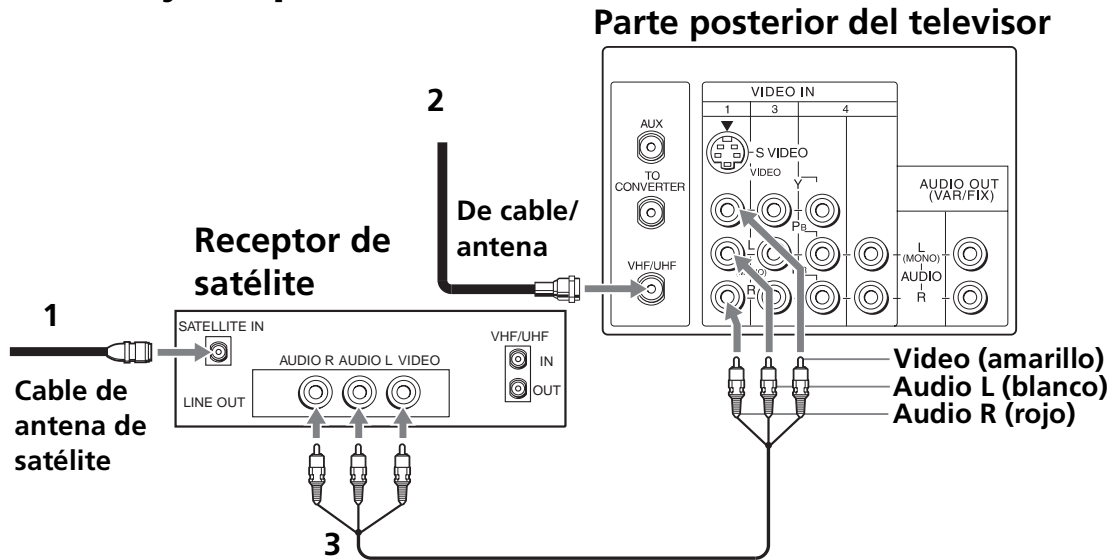

- 1** Conecte el cable de su antena de satélite a la entrada SATELLITE IN de su receptor de satélite.
- 2** Conecte el cable coaxial de su sistema de cable o antena a la entrada VHF/UHF de su televisor.
- 3** Con cables de Audio/Video (no incluidos), conecte las salidas AUDIO y VIDEO OUT de su receptor de satélite a las entradas AUDIO y VIDEO IN de su televisor.



Para obtener una calidad de imagen óptima, utilice S VIDEO en lugar del cable de Audio/Video amarillo. Puesto que S VIDEO no proporciona sonido, es preciso conectar los cables de audio.

Puede utilizar el botón para cambiar entre las entradas de VHF/UHF y de receptor de satélite.

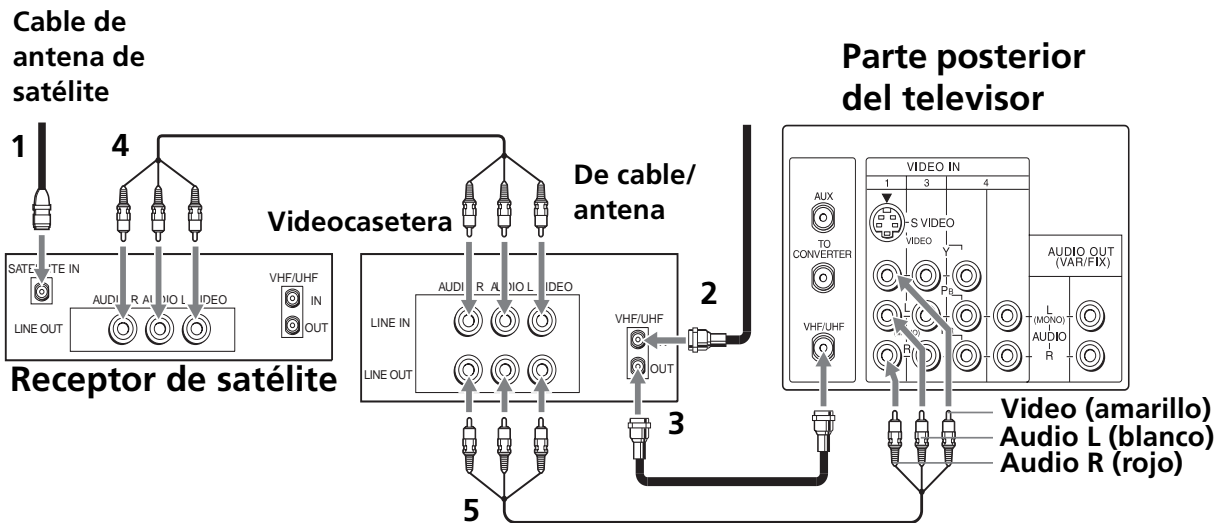
Televisor, receptor de satélite y videocasetera



- 1** Conecte el cable de su antena de satélite a la entrada SATELLITE IN de su receptor de satélite.
- 2** Conecte el cable coaxial de su sistema de cable o antena a la entrada IN de su videocasetera.
- 3** Empleando un cable coaxial (no incluido), conecte la salida OUT de su videocasetera a la entrada VHF/UHF de su televisor.
- 4** Con cables de Audio/Video (no incluidos), conecte las salidas AUDIO y VIDEO OUT de su receptor de satélite a las entradas AUDIO y VIDEO IN de su videocasetera.
- 5** Con cables de Audio/Video (no incluidos), conecte las salidas AUDIO y VIDEO OUT de su videocasetera a las entradas AUDIO y VIDEO IN de su televisor.

 Para ver la entrada del receptor de satélite o de la videocasetera, seleccione la entrada de video a la que esté conectado el receptor o la videocasetera; para ello, oprima  en el control remoto.

Conexión de una cámara de video

Con cables de Audio/Video (no incluidos), conecte las salidas AUDIO y VIDEO OUT de su cámara de video a las entradas AUDIO y VIDEO IN de su televisor.

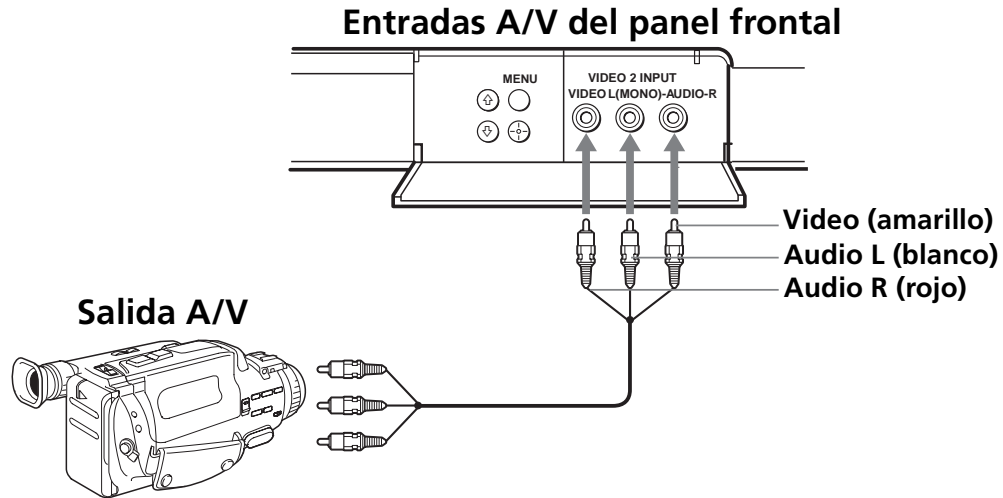

Si dispone de una cámara de video equipada de S VIDEO, podrá utilizar un cable S VIDEO para obtener imágenes de óptima calidad.

Conexión de un reproductor DVD

Con cables Audio/Video (no incluidos), conecte la salida AUDIO y VIDEO OUT de su reproductor DVD a las entradas AUDIO y VIDEO IN de su televisor.

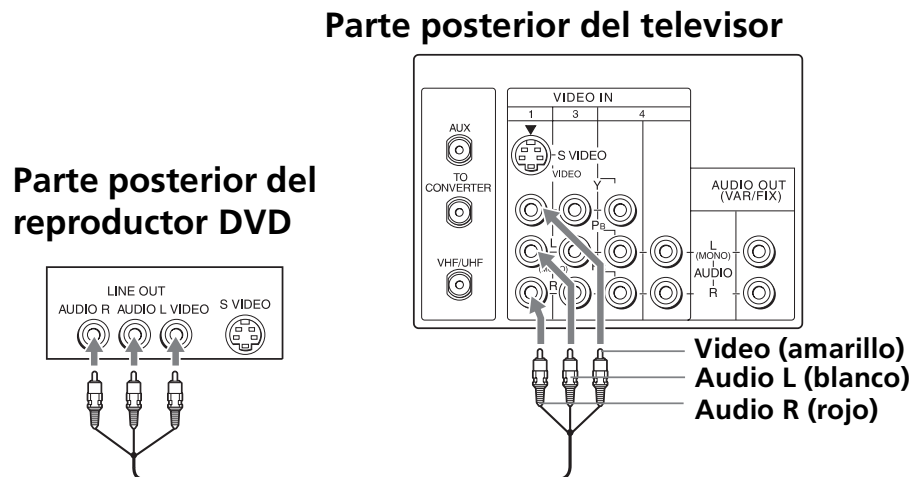



Para obtener una calidad de imagen óptima, utilice S VIDEO en lugar del cable de Audio/Video amarillo. Puesto que S VIDEO no proporciona sonido, es preciso conectar los cables de audio.

Conexión de un sistema de audio

Con cables de audio (no incluidos), conecte la salida AUDIO OUT de su televisor a una de las entradas de línea que no se utilice (p.ej. TV, AUX, TAPE2) de su sistema estéreo.

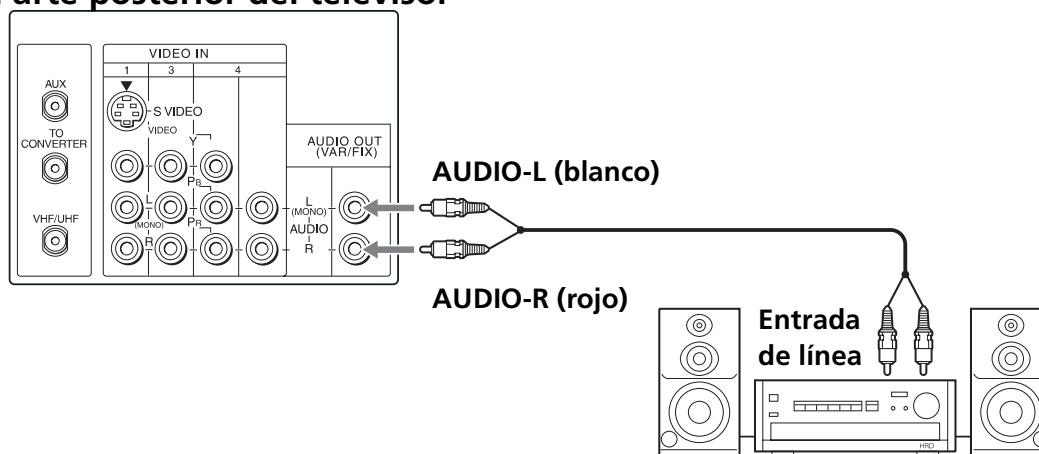
Parte posterior del televisor





 Ajuste el sistema estéreo en la entrada de línea seleccionada. Consulte la página 24 para obtener instrucciones complementarias sobre ajustes de audio.

Uso del control remoto y las funciones básicas

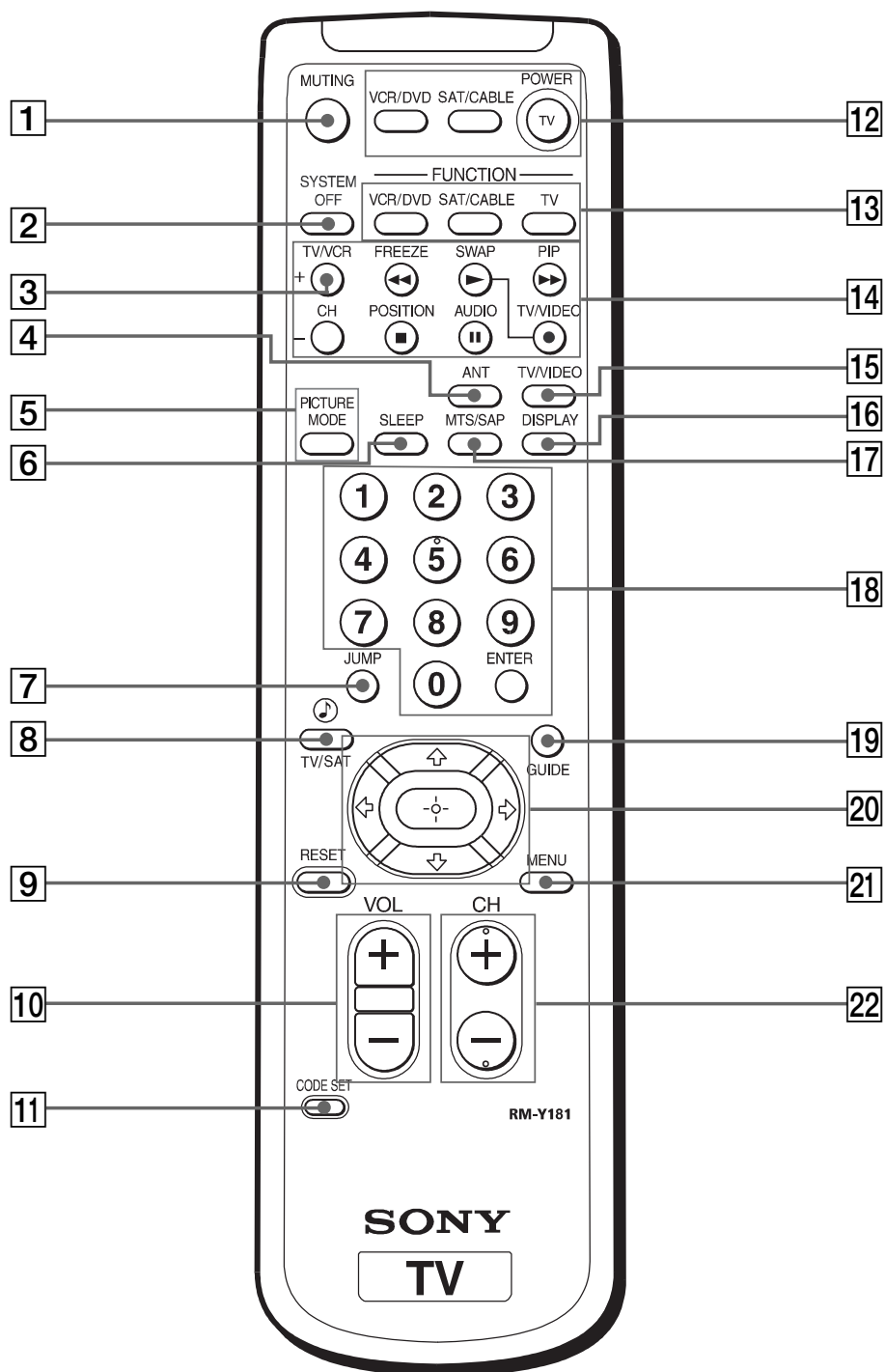
En esta sección se explica cómo utilizar los botones más avanzados del control remoto, así como los menús en pantalla.





Uso del control remoto

Botón	Descripción
1 MUTING	Apaga el sonido instantáneamente. Oprímalo de nuevo u oprima  para encender el sonido de nuevo.
2 SYSTEM OFF	Apaga simultáneamente todos los equipos Sony (puede no funcionar con equipos más antiguos).
3 TV/VCR	Oprímalo cuando termine de utilizar una videocasetera y desee cambiar a la entrada de televisión. La alimentación de la videocasetera permanecerá activada.
4 ANT (antena)	Oprímalo para cambiar la entrada VHF/UHF a la entrada AUX.
5 PICTURE MODE	Recorre cíclicamente los ajustes de modo de video disponibles.
6 SLEEP	Apaga el televisor automáticamente en 15, 30, 45, 60, 90 o 120 minutos aproximadamente. Para cancelar, oprímalo hasta que aparezca SLEEP OFF.
7 JUMP	Permite alternar entre los dos últimos canales seleccionados con los botones 0 - 9 .
8 	Recorre cíclicamente los ajustes de sonido estable (Steady Sound) disponibles (consulte la página 24).
9 RESET	Oprímalo para volver a los ajustes de fábrica desde un menú en pantalla.
10 VOL (volumen)	Oprímalo cuando desee ajustar el volumen.
11 CODE SET	Utilícelo para programar el control remoto con el fin de hacer funcionar equipos de video conectados (consulte la página 32).
12 POWER	Oprímalo para encender y apagar el equipo conectado.
13 FUNCTION	Oprímalo para controlar el equipo conectado mediante el control remoto.
14 Imagen en imagen (PIP)	Activa la función PIP. Para utilizar la función PIP, consulte la página 18.

 El control remoto mostrado en la página 14 (RM-Y181) es sólo para el modelo KV-34FS17. Su control remoto puede no ser como el que aparece en las ilustraciones.

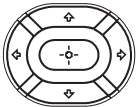
(continúa)

15	TV/VIDEO	Recorre cíclicamente las entradas de video disponibles.
16	DISPLAY	Oprímalo una vez para mostrar la hora actual (si está ajustada) y el número de canal. Para cancelar, oprímalo hasta que aparezca la indicación "DISPLAY OFF".
17	MTS/SAP	Oprima este botón para recorrer las opciones Multi-channel TV Sound (MTS) (opciones de sonido multicanal del televisor): Estéreo, Mono y Auto-SAP (segundo programa de sonido).
18	0-9 y ENTER	Permiten cambiar de canal directamente e introducir valores numéricos en indicaciones en pantalla.
19	GUIDE	Permite acceder a la guía personalizada del receptor de satélite.
20		Mueve el cursor por los menús en pantalla. Oprima los botones de flecha para mover el cursor. Oprima el botón central para seleccionar o acceder a una opción.
21	MENU	Muestra el menú en pantalla. Oprímalo de nuevo para salir del menú en cualquier momento.
22	CH (canal)	Oprímalo cuando desee cambiar de canal.

 Para obtener información sobre los botones de utilización de Imagen en imagen (PIP), consulte la página 18.



 Si pierde el control remoto, consulte la página 38.

Programación automática del televisor

Después de conectar el televisor, puede ejecutar Auto Programación para programar los canales.

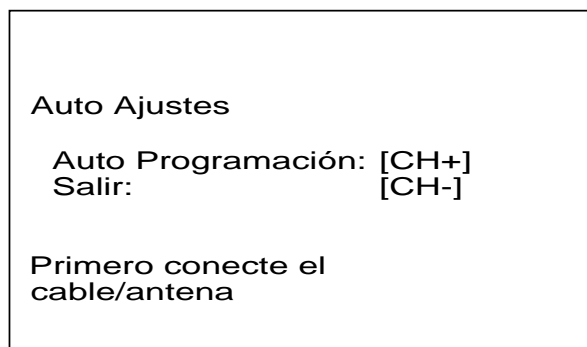









- 1 Oprima  para encender el televisor. Aparece la pantalla de Configuración inicial. (Sólo para el modelo KV-34FS13A, oprima el botón  antes de oprimir .





- 2 Oprima el botón TV FUNCTION.
- 3 Oprima  en el control remoto o en el panel frontal del televisor para realizar la Auto Programación, u oprima  para salir.

 La pantalla de ajuste inicial aparecerá cada vez que encienda el televisor hasta que ejecute Auto Programación.

Para volver a ejecutar Auto Programación

- 1 Oprima .
- 2 Oprima  para resaltar el menú Ajuste de Canal ().
- 3 Oprima  para resaltar Cable. Oprima  para seleccionar.
- 4 Oprima  o  para seleccionar SI o NO en función de cómo conectó su televisor. Oprima .
- 5 Oprima  para resaltar Auto Programación. Oprima  para buscar canales.

 Cuando termine Auto Programación, oprima  para salir.

Uso de Imagen en imagen (PIP)

La función Imagen en imagen (PIP) permite ver dos canales simultáneamente, uno al tamaño normal como imagen “principal” y el otro en una imagen pequeña conocida como “ventana”.

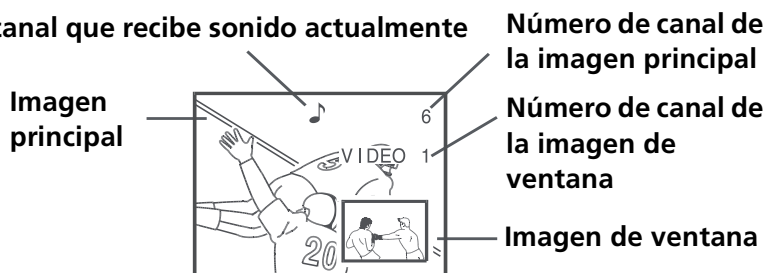

Sintonizador dual PIP

Sólo para el modelo KV-34FS17

Estos modelos están equipados con sintonizadores duales. Esto significa que PIP está “listo para utilizarse”.

	Oprímalo para activar y desactivar la función PIP. Oprímalo varias veces para cambiar el tamaño de la imagen de ventana y para desactivar la función PIP.
	Oprímalo varias veces para recorrer cíclicamente las entradas de video disponibles del equipo de video que haya conectado al televisor.
	Oprima este botón para alternar entre el sonido de la imagen principal y el de la imagen de ventana. El símbolo de sonido aparece durante 3 segundos, indicando si escucha el sonido de la imagen principal o el de la de ventana.
	Oprímalo para cambiar de canal en la imagen de ventana. Para cambiar el canal de la ventana principal, utilice los botones CH+/- principales de la parte inferior del control remoto.
	Oprímalo para cambiar la ubicación de la imagen de ventana entre las cuatro esquinas de la pantalla.
	Oprímalo para congelar la imagen de ventana. Oprímalo de nuevo para restaurar la imagen.
	Oprímalo para cambiar la imagen principal y la de ventana. Oprímalo de nuevo para volver a cambiarlas.



La entrada AUX no se puede ver en la imagen de ventana.

Para obtener más información sobre el control remoto, consulte la página 14.

Para utilizar PIP

- 1** Oprima el botón TV FUNCTION del control remoto para ver algún canal activo.
- 2** Oprima el botón  para que aparezca la imagen de ventana.
- 3** Utilice los botones de color amarillo del control remoto para controlar las funciones PIP. Consulte la página 18 para obtener descripciones sobre los botones de control de PIP.

Para comprobar la imagen PIP



- 1** Oprima el botón TV FUNCTION del control remoto para ver algún canal activo.
- 2** Oprima el botón  y seleccione de nuevo el mismo canal. En este momento, el mismo programa debe aparecer en las ventanas principal y de imagen.
- 3** Utilice los botones CH+/- amarillos para cambiar de canal en la ventana de imagen.
- 4** Utilice ahora los botones CH+/- principales de la parte inferior del control remoto para cambiar de canal en la ventana principal.
- 5** Oprima el botón  para cambiar a otras entradas de video de otros equipos que estén conectados a cualquiera de las tomas VIDEO IN del panel posterior del televisor. Debe ver una imagen diferente en la ventana PIP correspondientes a cada uno de los componentes de equipo de video conectados. Compruebe que el equipo conectado está encendido y en funcionamiento cuando realice esta prueba.
- 6** Si la función PIP no se activa correctamente con el televisor o el componente de equipo de video conectado, consulte la sección Solución de problemas en las páginas 37-38 para obtener posibles soluciones.

 Todos los equipos de video que haya conectado a la entrada AUX no pueden verse en la ventana PIP.

 Si ve todos los canales a través de un decodificador, la función PIP no se activará. Puesto que el decodificador sólo decodifica una señal cada vez, la imagen de ventana será la misma que la principal. No obstante, es posible visualizar un canal de cable y otra fuente de video. Compruebe que el reproductor DVD, videocasetera o receptor de satélite está conectado a las tomas VIDEO IN del panel posterior del televisor, no a la entrada AUX.

Acceso rápido a los menús

Los siguientes ajustes están disponibles en los menús en pantalla:

Menú	Permite
 <p>Video Audio Canal Paterno Reloj Ajustes Básico</p> <p>Modo: Vívido Contraste Brillo Color Tinte Nitidez Calidez: Frío MV: Alto</p> <p>Mover Seleccionar Salir </p>	Hacer ajustes a la imagen.
 <p>Video Audio Canal Paterno Reloj Ajustes Básico</p> <p>Agudos Graves Balance Auto Volumen: SI Efecto: NO MTS: Estéreo Bocinas: SI Salida: Variable</p> <p>Mover Seleccionar Salir </p>	Cambiar los ajustes de audio.
 <p>Video Audio Canal Paterno Reloj Ajustes Básico</p> <p>Canal Favorito Cable: NO Fijar Canal: NO Auto Programación Omitir/Añadir Canal Nombre de Canal</p> <p>Mover Seleccionar Salir </p>	Personalizar los ajustes de canales.

Los menús ilustrados en este manual corresponden al modelo KV-34FS17. Es posible que sus menús sean diferentes a estos.

Menú

Permite

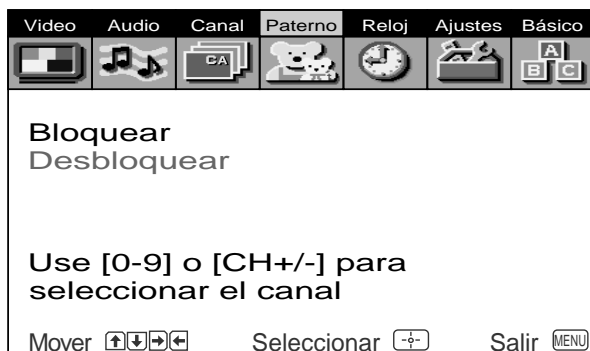

Definir límites de clasificación en su televisor basados en clasificaciones o contenidos de los programas.



Ajustar el reloj de su televisor y programar la visualización de programas específicos usando Reloj 1 y Reloj 2.



Programar canales, etiquetar entradas de video, seleccionar el idioma de los menús o ejecutar una demostración de éstos (Sistema de Color sólo para el modelo KV-34FS13A).











Seleccionar ajustes básicos para el televisor.

Uso de los menús

En esta sección se muestran las opciones disponibles para programar y ajustar su televisor.

Para acceder a un menú

- 1** Oprima  para visualizar el menú en pantalla.
- 2** Utilice  o  para resaltar el menú que desee y oprima .
- 3** Utilice los botones  o  para resaltar la opción que desee y oprima  (el ajuste ó las opciones de esta función aparecerá en la pantalla).
- 4** Oprima  para completar el ajuste.
- 5** Oprima  para salir del menú.

Uso del menú de Video

Para acceder el menú de Video, realice los siguientes pasos:





Modo
Visualización de imagen personalizada

Vívido: Seleccione este modo para aumentar el contraste y la nitidez de la imagen.

Estándar: Seleccione este modo para ver imágenes cotidianas.

Deportes: Seleccione este modo para ver imágenes con mas brillo.

Película: Seleccione este modo para ver imágenes con mayor detalle.

 Oprima  para acceder directamente a ajustes de Modo (Vívido, Estándar, Deportes, Película).

Contraste
Contraste de imagen

Oprima \leftarrow para disminuir el contraste de la imagen.

Oprima \rightarrow para aumentar el contraste de la imagen.

Brillo
Ajuste de la imagen

Oprima \leftarrow para disminuir el brillo de la imagen.

Oprima \rightarrow para aumentar el brillo de la imagen.

Color
Saturación del color

Oprima \leftarrow para disminuir la saturación del color.

Oprima \rightarrow para aumentar la saturación del color.

Tinte
Tonos del color

Oprima \leftarrow para aumentar los tonos rojos.

Oprima \rightarrow para aumentar los tonos verdes.

Nitidez
Detalle de la imagen

Oprima \leftarrow para suavizar la imagen.

Oprima \rightarrow para agudizar la imagen.

Calidez
Ajuste de intensidad del blanco

Frío: Proporciona un matiz azulado a los colores blancos.

Neutro: Proporciona un matiz neutro a los colores blancos.

Cálido: Proporciona un matiz rojizo a los colores blancos.

MV
Modulación de velocidad

Agudiza la definición de la imagen para que los objetos adquieran un borde perfilado. Seleccione una de las siguientes opciones: **Alto, Bajo, NO.**

Uso del menú de Audio

Para acceder el menú de Audio, realice los siguientes pasos:



- | | |
|---|--|
| Agudos | Oprima ⇐ para disminuir los sonidos agudos.
Oprima ⇒ para aumentar los sonidos agudos. |
| Graves | Oprima ⇐ para disminuir los sonidos graves.
Oprima ⇒ para aumentar los sonidos graves. |
| Balance | Oprima ⇐ para potenciar el sonido de la bocina izquierda.
Oprima ⇒ para potenciar el sonido de la bocina derecha. |
| Auto Volumen
<i>Estabiliza el volumen</i> | Oprima ⬆ o ⬇ para seleccionar una de las siguientes opciones:
SI: Selecciónelo para estabilizar el volumen al cambiar de canal.
NO: Selecciónelo para desactivar Auto Volumen. |

 Oprima  para seleccionar directamente ajustes de Auto Volumen.

- | | |
|---------------|---|
| Efecto | Oprima ⬆ o ⬇ para seleccionar una de las siguientes opciones:
NO: Recepción estereofónica o monofónica normal.
Surround: Simula el sonido con calidad de sala de cine para programas estéreo. |
|---------------|---|



MTS
Sonido multicanal

Estéreo: Selecciónelo cuando visualice una emisión en estéreo.

Mono: Selecciónelo para reducir el ruido en zonas de recepción deficiente.

Auto-SAP: Selecciónelo para que el televisor cambie automáticamente a un segundo programa de sonido (SAP) al recibirse una señal.

 Si el televisor está ajustado en Auto-SAP, puede que algunos programas no se oigan o que aparezcan distorsionados. Si el televisor no emite sonido, cambie los ajustes de Audio a Estéreo o Mono.

 Oprima  para realizar ajustes de MTS directamente (Estéreo, Mono, Auto-SAP).

Bocinas
Selección personalizada de fuentes de salida de audio

SI: Selecciónelo para escuchar el sonido a través de las bocinas del televisor con o sin un sistema estéreo independiente.

NO: Selecciónelo para desactivar las bocinas del televisor y escuchar el sonido de éste sólo a través de las bocinas de un sistema de sonido externo.

Salida
Utilícelo para controlar el volumen del televisor mediante un sistema estéreo

Utilice Salida solamente cuando haya un sistema de audio externo conectado al televisor.

Variable: Ajuste el volumen mediante el televisor.

Fija: Ajuste el volumen del televisor mediante un sistema estéreo conectado.

 Salida sólo puede ajustarse cuando Bocinas está desactivado (NO).

Uso del menú de Ajuste de Canal













Para acceder al menú de Ajuste de Canal, realice los siguientes pasos:









Canal Favorito

Acceso rápido a canales favoritos

Con el menú de Canal Favorito abierto:

- 1 Oprima  para seleccionar.
- 2 Utilice los botones  o  para seleccionar Auto o Manual. Si selecciona Auto, aparecerán los últimos siete canales a los que acceso mediante los botones -.
- 3 Cuando se encuentre en Manual, oprima  y, a continuación,  para seleccionar la posición (1-7) en la que desee ajustar un canal favorito. Después oprima .
- 4 Con los botones  o , seleccione el canal deseado.
- 5 Oprima  para cambiar al canal introducido. Oprima  para salir.

 Para utilizar Canal Favorito: Salga de todos los menús y oprima . Oprima  o  para desplazar el cursor al número de canal que desee, y oprima .

 Después de cerrar el menú, aparece la imagen de ventana PIP para que pueda previsualizar el canal favorito (sólo KV-34FS17).

Cable

SI: Selecciónelo si está recibiendo canales por cable con un cable CATV.

NO: Selecciónelo si está utilizando una antena de televisión.

 Después de cambiar los ajustes de cable, será necesario ejecutar Auto Programación.

Fijar Canal	<p>2-6: Selecciónelo cuando desee controlar la selección de todos los canales a través del decodificador o videocasetera. Seleccione el canal adecuado (normalmente 3 o 4) y utilice el control remoto del decodificador o de la videocasetera para la selección de canal.</p> <p>Video 1: Seleccione una de las entradas de video accesibles cuando esté conectado al equipo de video (p. ej., receptor de satélite) y quiera fijar su televisor a ésta.</p> <p>AUX 2-6: Utilice este ajuste en lugar de 2-6 si desea cambiar de canal mediante un decodificador, videocasetera o receptor de satélite y lo haya conectado a la entrada AUX (sólo KV-34FS17).</p> <p>NO: Fijar Canal no se ajustará.</p>
Auto Programación	<p>Ejecute Auto Programación siempre que programe su televisor. Recorrerá todos los canales disponibles y programará los que se reciben.</p>
Omitir/Añadir Canal	<p>Utilice esta función después del ejecutar Auto Programación para omitir los canales que no desee o para añadir canales nuevos.</p> <ol style="list-style-type: none"> 1 Utilice los botones 0-9 o [CH+/-] para seleccionar el canal. 2 Oprima + para omitir o añadir (sólo habrá disponible una opción).
Nombre de Canal	<p>Con la ventana Nombre de Canal abierta:</p> <ol style="list-style-type: none"> 1 Oprima + y, a continuación, ↑ o ↓ hasta que llegue al número del canal deseado. 2 Oprima + para activar el canal. 3 Oprima ↓ y, a continuación, + para resaltar el campo de nombre. 4 Oprima ↑ o ↓ para visualizar el primer número o letra del nombre y oprima + para seleccionarlo. Cuando termine, oprima + para activarlo.

 Canal Favorito, Omitir/Añadir Canal y Nombre de Canal no pueden usarse cuando Fijar Canal está ajustado.

Uso del menú Paterno

Para acceder al menú Paterno, realice los siguientes pasos:

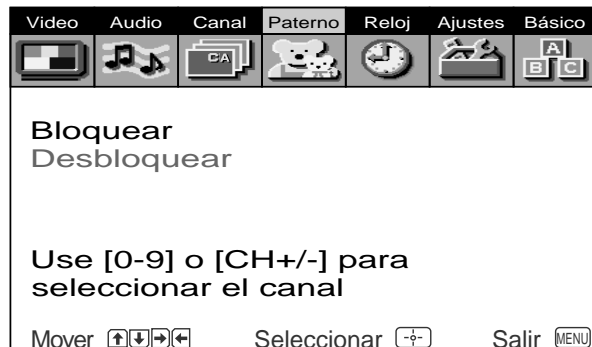

Con el menú Paterno abierto, oprima  para seleccionar Bloquear o Desbloquear:



Bloquear

Use **0-9** o [CH +/-] para elegir un canal que desee bloquear, y después oprima  para seleccionar.

 Cuando un canal se bloquea, aparece en forma de pantalla negra con la palabra "Bloqueado" sobre la pantalla (sólo en el uso normal de la TV).

Desbloquear

Use **0-9** o [CH +/-] para elegir el canal que desee desbloquear, y después oprima  para seleccionar.

 Para cancelar todos los canales bloqueados, abra el menú Paterno y oprima .

Uso del menú de Reloj

Para acceder el menú de Reloj, realice los siguientes pasos:

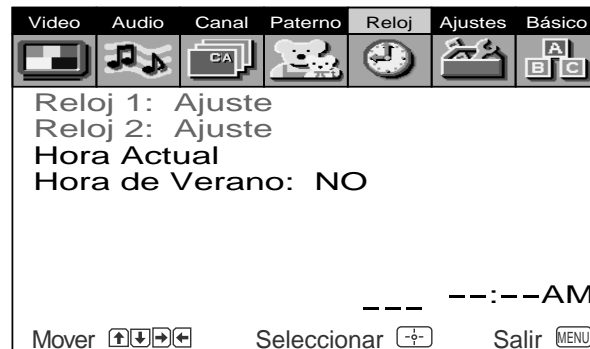



Hora Actual	<p>Con el menú abierto:</p> <ol style="list-style-type: none"> 1 Oprima \uparrow o \downarrow para seleccionar la hora actual y, después, oprima \ominus. (Si se encuentra en la Hora de Verano, asegúrese de ajustar Hora de Verano en "SI"). 2 Oprima \uparrow o \downarrow para introducir la hora actual y, después, oprima \ominus. 3 Oprima MENU para salir del menú.
Reloj 1 y Reloj 2 <i>Visualización programada</i>	<p>Con el menú abierto, coloque el cursor en Reloj 1 o Reloj 2:</p> <ol style="list-style-type: none"> 1 Oprima \uparrow o \downarrow para seleccionar Reloj 1 o Reloj 2 y, después, oprima \ominus. 2 Oprima \uparrow o \downarrow para introducir la hora y canal que prefiera y, después, oprima \ominus. 3 Oprima MENU para salir del menú.

 Es preciso ajustar Hora Actual para poder utilizar Reloj 1 y Reloj 2.

 Es posible ajustar el Reloj en SI, NO o Ajuste. Una vez programado el reloj, podrá activarlo o desactivarlo sin necesidad de realizar los distintos ajustes.

Hora de Verano	<p>SI: Selecciónelo en primavera para compensar la hora de verano. NO: Selecciónelo en otoño al final de la Hora de Verano.</p>
-----------------------	---

 Al ejecutar Auto Programación, se borrarán todos los ajustes de Reloj 1 y Reloj 2.

 En caso de interrupción de alimentación, se borrarán los ajustes de Hora Actual, Reloj 1 y Reloj 2.

Uso del menú de Ajustes

Para acceder el menú de Ajustes, realice los siguientes pasos:





Caption Vision <i>Subtítulos</i>	Permite realizar la selección entre los tres modos de subtítulo (para programas que se emiten con subtítulos). Oprima ↑ o ↓ para seleccionar una de las siguientes opciones: NO: Desactiva Caption Vision. CC1, 2, 3, 4: Muestra el diálogo impreso y los efectos de sonido de un programa. TXT1, 2, 3, 4: Muestra información de la red/emisora. XDS (Servicio ampliado de datos): Muestra información sobre la emisora y el programa actual, si está disponible.
Etiqueta de Video <i>Nombre de equipos conectados</i>	Permite asignar nombre a los equipos de audio/video que haya conectado al televisor para poder identificarlos cuando se encuentre en el modo Desplegado. Con la ventana Etiqueta de Video abierta: 1 Oprima ↑ o ↓ para acceder a la entrada a la que desee asignar nombre y oprima Enter/Select . 2 Oprima ↑ o ↓ para elegir un nombre y oprima Enter/Select .
Rotación	Oprima ↓ o ↑ para corregir cualquier inclinación que se aprecie en la imagen entre -5 y +5. Oprima Enter/Select para activarlo.
Lenguaje	Selecciónelo para mostrar todos los menús en el idioma que desee. Utilice los botones ↑ o ↓ , seleccione el idioma que desee y oprima Enter/Select .
16:9 Realzado	Proporciona una resolución realzada de imagen para fuentes de pantalla panorámica como DVD (disponible solamente cuando el televisor se encuentra en el modo de Video).
Demostración	Selecciónelo para ver una demostración de los menús en pantalla.
Sistema de Color	Seleccione un ciclo a través de AUTO (ajuste de fábrica), NTSC, PALM, PALN para TV, Video 1, Video 2 y Video 3.

Uso del menú Básico

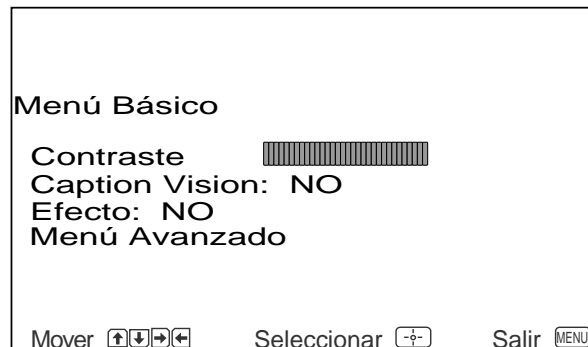
Para acceder el menú Básico, realice los siguientes pasos:







<p>Contraste <i>Contraste de imagen</i></p>	<p>Oprima ⇐ para disminuir el contraste de la imagen. Oprima ⇒ para aumentar el contraste de la imagen.</p>
<p>Caption Vision <i>Subtítulos</i></p>	<p>Permite realizar la selección entre los tres modos de subtítulo (para programas que se emiten con subtítulos). Oprima ⬆ o ⬇ para seleccionar una de las siguientes opciones: NO: Caption Vision no se activa. CC1, 2, 3, 4: Muestra el diálogo impreso y los efectos de sonido de un programa. TXT1, 2, 3, 4: Muestra información de la red/emisora. XDS (Servicio ampliado de datos): Muestra información sobre la emisora y el programa actual, si está disponible.</p>
<p>Efecto</p>	<p>Oprima ⬆ o ⬇ para seleccionar una de las siguientes opciones: NO: Recepción estereofónica o monofónica normal. Surround: Simula el sonido con calidad de sala de cine para programas estéreo.</p>
<p>Menú Avanzado</p>	<p>Selecciónelo para volver a los menús principales.</p>

 Si utiliza el botón  para cerrar el menú Básico, sólo aparecerá dicho menú al oprimir  de nuevo. Para tener acceso a otros menús, utilice ⬇ para seleccionar el menú Avanzado.

Información adicional

Programación del control remoto

Se puede utilizar el control remoto que se suministra para poner en funcionamiento tanto equipos de video Sony como equipos de otras marcas.

- 1 Oprima .
- 2 Oprima  o  (FUNCTION).
- 3 Utilice los botones ①-⑨ para introducir el número de código de la siguiente tabla.
- 4 Oprima .

Códigos de videocaseteras

Sony	301, 302, 303	JCPenney	309, 305, 304, 330, 314, 336, 337
Admiral (M.Ward)	327	JVC	314, 336, 337, 345, 346, 347
Aiwa	338, 344	Kenwood	314, 336, 332, 337
Audio Dynamic	314, 337	LXI (Sears)	332, 305, 330, 335, 338
Broksonic	319, 317	Magnavox	308, 309, 310
Canon	309, 308	Marantz	314, 336, 337
Citizen	332	Marta	332
Craig	302, 332	Memorex	309, 335
Criterion	315	Minolta	305, 304
Curtis Mathis	304, 338, 309	Mitsubishi/MGA	323, 324, 325, 326
Daewoo	341, 312, 309	Multitech	325, 338, 321
DBX	314, 336, 337	NEC	314, 336, 337
Dimensia	304	Olympic	309, 308
Emerson	319, 320, 316, 317, 318, 341	Optimus	327
Fisher	330, 335	Panasonic	308, 309, 306, 307
Funai	338	Pentax	305, 304
General Electric	329, 304, 309	Philco	308, 309
Go Video	322, 339, 340	Philips	308, 309, 310
Goldstar	332	Pioneer	308
Hitachi	306, 304, 305, 338	Quasar	308, 309, 306
Instant Replay	309, 308	RCA/PROSCAN	304, 305, 308, 309, 311, 312, 313, 310, 329

Códigos de videocaseteras

Realistic	309, 330, 328, 335, 324, 338
Sansui	314
Samsung	322, 313, 321
Sanyo	330, 335
Scott	312, 313, 321, 335, 323, 324, 325, 326
Sharp	327, 328
Shintom	315
Signature 2000 (M.Ward)	338, 327
SV2000	338
Sylvania	308, 309, 338, 310

Códigos de decodificadores

Hamlin/Regal	222, 223, 224, 225, 226
Jerrold/G. I.	201, 202, 203, 204, 205, 206, 207, 208, 218
Oak	227, 228, 229
Panasonic	219, 220, 221
Pioneer	214, 215
Scientific Atlanta	209, 210, 211
Tocom	216, 217
Zenith	212, 213

Códigos de reproductores de discos láser

Sony	701
Panasonic	704, 710
Pioneer	702

Códigos de DBS

DIRECTV	809
Echostar/Dish Network	810

Symphonic	338
Tashiro	332
Tatung	314, 336, 337
Teac	314, 336, 338, 337
Technics	309, 308
Toshiba	312, 311
Wards	327, 328, 335, 331, 332
Yamaha	314, 330, 336, 337
Zenith	331

Códigos de receptores de satélite

Sony	801
General Electric	802
Hitachi	805
Hughes	804
Panasonic	803
RCA/PROSCAN	802, 808
Toshiba	806, 807

Códigos de reproductores DVD









Sony	751
JVC	756
Mitsubishi	761
Onkyo	762
Oritron	759
Panasonic	753
Philips/Magnavox	757
Pioneer	752
RCA	755
Samsung/Hitachi	758
Toshiba	754
Zenith	760

 Si se indica más de un número de código, intente introducirlos uno por uno hasta que encuentre el correcto para su equipo.



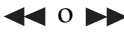





 Cuando quite las baterías, los números de código pueden regresar al ajuste de fábrica y será preciso volver a ajustarlos.

 En casos excepcionales, es posible que no se pueda emplear el equipo con el control remoto suministrado. En este caso, utilice el control remoto suministrado con el equipo.



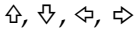

Empleo de una videocasetera

Oprima	Para
	Encender la videocasetera
	Seleccionar canales directamente
	Cambiar de canal
	Reproducir cintas de video
	Detener el funcionamiento
	Buscar hacia delante o atrás
	Introducir pausas
 y  (simultáneamente)	Grabar
	Cambiar entre las entradas de videocasetera y televisor

Empleo de un reproductor DVD

Oprima	Para
	Encender el reproductor DVD
	Seleccionar capítulos directamente
	Buscar capítulos hacia delante o atrás
	Reproducir un DVD
	Detener el funcionamiento
	Introducir pausas
	Desplazar el cursor por el menú
	Mostrar el menú DVD



Empleo de un reproductor de discos láser











Oprima	Para
VCR/DVD 	Encender el reproductor de discos láser
CH ⊕ ⊖	Buscar capítulos hacia delante o atrás
	Reproducir discos
	Detener el funcionamiento
	Introducir pausas

Solución de problemas

Si tiene algún problema con su televisor, consulte las sugerencias siguientes. Si el problema no se soluciona, póngase en contacto con su distribuidor Sony.

Ausencia de imagen y de sonido	<ul style="list-style-type: none"> <input type="checkbox"/> Asegúrese de que el cable de alimentación está enchufado. <input type="checkbox"/> Si la luz roja de la parte frontal del televisor parpadea durante más de unos minutos, desconecte y vuelva a conectar el cable de alimentación para restablecer el televisor. Si el problema continúa, llame al centro de asistencia técnica local. <input type="checkbox"/> Compruebe los ajustes TV/VIDEO: cuando vea la televisión, utilice el ajuste TV y, cuando emplee el equipo de video, utilice el ajuste VIDEO (página 16). <input type="checkbox"/> Asegúrese de que las baterías se han insertado en el control remoto correctamente (página 2). <input type="checkbox"/> Pruebe otro canal, ya que los problemas podrían proceder de la emisora.
Sin imagen o imagen defectuosa, buen sonido	<ul style="list-style-type: none"> <input type="checkbox"/> Ajuste Contraste en el menú de Video (página 23). <input type="checkbox"/> Ajuste Brillo en el menú de Video (página 23). <input type="checkbox"/> Compruebe las conexiones de antena y/o cable (página 3).
Buena imagen, sin sonido	<ul style="list-style-type: none"> <input type="checkbox"/> Oprima MUTING para que desaparezca MUTING de la pantalla (página 15). <input type="checkbox"/> Compruebe los ajustes de Audio. El televisor puede estar ajustado en Auto-SAP (página 25).
Sin color	<ul style="list-style-type: none"> <input type="checkbox"/> Ajuste Color en el menú de Video (página 23).
Sin señal	<ul style="list-style-type: none"> <input type="checkbox"/> Compruebe el ajuste Cable del menú de Ajuste de Canal (página 26). <input type="checkbox"/> Compruebe las conexiones de antena y/o cable (página 3). <input type="checkbox"/> Asegúrese de que el canal seleccionado emite actualmente.
Rayas o líneas con puntos	<ul style="list-style-type: none"> <input type="checkbox"/> Ajuste la antena. <input type="checkbox"/> Aleje el televisor de cualquier otro equipo electrónico. Algunos equipos electrónicos pueden crear ruido eléctrico que interfiera con la recepción de televisión.

Imágenes dobles o fantasma	<ul style="list-style-type: none"> <input type="checkbox"/> Compruebe la antena exterior o llame al proveedor del servicio de cable.
No puede recibir canales de banda alta (UHF) cuando utiliza una antena	<ul style="list-style-type: none"> <input type="checkbox"/> Asegúrese de que Cable está ajustado en la posición NO en el menú de Ajuste de Canal (página 26). <input type="checkbox"/> Utilice Auto Programación para añadir canales que no están en la memoria (página 17).
Parece que las emisoras por cable no funcionan	<ul style="list-style-type: none"> <input type="checkbox"/> Asegúrese de que Cable está ajustado en la posición SI en el menú de Ajuste de Canal (página 26). <input type="checkbox"/> Utilice Auto Programación para añadir canales que no están en la memoria (página 17).
El control remoto no funciona	<ul style="list-style-type: none"> <input type="checkbox"/> Las baterías podrían estar bajas. Sustitúyalas (página 2). <input type="checkbox"/> Aleje el televisor 1 metro aproximadamente de las luces fluorescentes.
Imposible cambiar de canal con el control remoto	<ul style="list-style-type: none"> <input type="checkbox"/> Asegúrese de que no ha cambiado accidentalmente el televisor del ajuste de canal 3 o 4 si utiliza otro dispositivo para cambiar de canal. <input type="checkbox"/> Si utiliza otro dispositivo para controlar los canales, asegúrese de oprimir el botón FUNCTION correspondiente a dicho dispositivo. Por ejemplo, si utiliza la videocasetera para controlar los canales, asegúrese de oprimir los botones VCR/DVD FUNCTION (página 15).
Es necesario limpiar el televisor	<ul style="list-style-type: none"> <input type="checkbox"/> Limpie el TV con un paño suave y seco. Nunca emplee disolventes, como diluyente de pintura o bencina, ya que pueden dañar el acabado exterior.
No puede acceder a otros menús mientras utiliza el menú Básico	<ul style="list-style-type: none"> <input type="checkbox"/> Si utiliza el botón  para cerrar el menú Básico, sólo aparecerá dicho menú al oprimir  de nuevo. Para tener acceso a otros menús, utilice el botón  para seleccionar el menú Avanzado (página 31).
El control remoto no funciona en el modo PIP	<ul style="list-style-type: none"> <input type="checkbox"/> Oprima el botón TV FUNCTION. Es posible que haya oprimido accidentalmente el botón VCR/DVD FUNCTION, que cambia los botones PIP al modo de videocasetera (página 15).

-
- | | |
|--|--|
| No aparece la imagen de ventana o aparece estática | <ul style="list-style-type: none">❑ Asegúrese de que la imagen de ventana está ajustada en una fuente de video/canal en el que se emita algún programa.❑ Es posible que haya sintonizado una entrada de video a la que no hay nada conectado. Recorra las entradas de video utilizando el botón PIP TV/VIDEO amarillo con punto rojo (página 18).❑ PIP no está ajustado para recibir la señal de la entrada AUX. Si ha conectado una videocasetera, reproductor DVD o receptor de satélite a la entrada AUX del televisor, la imagen no aparecerá en la ventana pequeña. |
| Aparece el mismo programa en la imagen de ventana y en la principal | <ul style="list-style-type: none">❑ Es posible que ambas estén ajustadas en el mismo canal. Cambie de canal en la imagen principal o en la de ventana (páginas 18-19).❑ Es posible que el televisor esté ajustado para seleccionar todos los canales mediante un decodificador. El decodificador sólo decodificará una señal cada vez, por lo que no es posible utilizar la función PIP. Si es posible, conecte un cable directo a la toma VHF/UHF del televisor. Esto sólo funcionará si el sistema de cable proporciona señales no codificadas (página 5). |
| Control remoto perdido | <ul style="list-style-type: none">❑ Puede utilizar los controles del panel frontal de audio/video para acceder a los menús. Oprima  para abrir el menú. Utilice los botones  o  del panel frontal de audio/video en lugar de los botones  o  del control remoto. Utilice el botón  del panel frontal de audio/video en lugar de los botones , , y  del control remoto. Oprima  de nuevo cuando haya completado el ajuste. Póngase en contacto con el distribuidor Sony más próximo para solicitar un control remoto. |
-

Si usted necesita asistencia adicional, llame al número de apoyo técnico de Sony correspondiente a su país. Uno de los profesionales de apoyo técnico de Sony estará encantado de asistirle.

Especificaciones

Para todos los modelos (excepto donde se indique)

Sistema de televisión	Estándar americano de TV/NTSC PALM/PALN/NTSC (KV-34FS13A)
Cobertura de canales	VHF: 2-13/UHF: 14-69/Cable: 1-125
Antena	Terminal de antena externa de 75 ohm para VHF/UHF
Tubo de imagen	FD Trinitron®
Requisitos del suministro eléctrico	ca 120-220 V 50/60 Hz (KV-34FS13A) ca 220 V 50 Hz (KV-34FS13C) ca 120 V 60 Hz (KV-34FS17)
Accesorios suministrados	Baterías tamaño AA (R6) (2) Control remoto RM-Y180 (1) (KV-34FS13A, KV-34FS13C) RM-Y181 (1) (KV-34FS17)
Accesorios opcionales	Cables de conexión VMC-810S/820S, VMC-720M, YC-YC-15V/30V, RK74A Mezclador de U/V EAC-66 Soporte para televisor: SU-32FD3
KV-34FS13A, KV-34FS13C	
Tamaño de pantalla	Tamaño de pantalla visible medida diagonalmente: 803 mm (32 pulgadas) Tamaño de pantalla real medida diagonalmente: 859 mm (34 pulgadas)
Entradas/Salidas	3 video, 3 audio 1 S VIDEO 1 salida de audio 1 entrada RF 1 Y, P _B , P _R , 1 audio
Salida de la bocina	10 W × 2
Consumo de energía	195 W en uso 1 W en espera
Dimensiones (An/Al/Prf)	700 × 632 × 512 mm (27 ⁵ / ₈ × 25 × 20 ¹ / ₄ pulgadas)
Peso	75 kg (163 lbs.)

KV-34FS17

Tamaño de pantalla	Tamaño de pantalla visible medida diagonalmente: 803 mm (32 pulgadas) Tamaño de pantalla real medida diagonalmente: 859 mm (34 pulgadas)
Entradas/Salidas	3 video, 3 audio 1 S VIDEO 1 salida de audio 2 entradas RF 1 Y, P _B , P _R , 1 audio
Salida de la bocina	10 W × 2
Consumo de energía	205 W en uso 1 W en espera
Dimensiones (An/Al/Prf)	762 × 604 × 519 mm (30 × 23 ⁷ / ₈ × 20 ¹ / ₂ pulgadas)
Peso	75 kg (163 lbs.)

El diseño y las especificaciones están sujetos a cambios sin previo aviso.

Índice alfabético

16:9 Realzado 30

A

Agudos 24
Auto Programación 17, 27
Auto-SAP 25
Auto Volumen 24

B

Balance 24
Bloquear 28
Bocinas 25
Brillo 23

C

Cable 26
Calidez 23
Canal Favorito 26
Caption Vision 30, 31
Color 23
Conexiones
 Cable y antena 3
 Conexión de un reproductor
 DVD 11
 Conexión de un sistema de
 audio 12
 Conexión de una cámara de
 video 11
 Decodificador y cable 5
 Decodificador y televisor 4
 Televisor y receptor de
 satélite 9
 Televisor, receptor de satélite
 y videocasetera 10
 Televisor y videocasetera 6
 Televisor, videocasetera y
 decodificador 7
Contraste 23, 31
Control remoto 14

D

Demostración 30
Desbloquear 28
DISPLAY 16

E

Efecto
 NO 24, 31
 Surround 24, 31
Especificaciones 39
Estéreo 25
Etiqueta de Video 30

F

Fijar Canal 27
Funciones del televisor 1

G

Graves 24

H

Hora Actual 29
Hora de Verano 29





I

Imagen en imagen (PIP) 18
Instalación de las baterías 2

L

Lenguaje 30

M

Menús
 Audio  24
 Básico  31
 Ajuste de Canal  26
 Paterno  28
 Ajustes  30
 Reloj  29
 Video  23

Modo

Deportes 23

Estándar 23

Película 23

Vívido 23

Mono 25

MTS

Auto-SAP 25

Estéreo 25

Mono 25

MV 23

N

Nitidez 23

Nombre de Canal 27

O

Omitir/Añadir Canal 27

P

Programación del control
remoto 32

R

Reloj 1 y Reloj 2 29

Rotación 30

S

Salida 25

Sistema de Color 30

SLEEP 15

Solución de problemas 36

T

Tinte 23

PRINTING THE SERVICE MANUAL

The PDF of this service manual is not designed to be printed from cover to cover. The pages vary in size, and must therefore be printed in sections based on page dimensions.

NON-SCHEMATIC PAGES

Data that does NOT INCLUDE schematic diagrams are formatted to 8.5 x 11 inches and can be printed on standard letter-size and/or A4-sized paper.

SCHEMATIC DIAGRAMS

The schematic diagram pages are provided in two ways, full size and tiled. The full-sized schematic diagrams are formatted on paper sizes between 8.5" x 11" and 18" x 30" depending upon each individual diagram size. Those diagrams that are LARGER than 11" x 17" in full-size mode have been tiled for your convenience and can be printed on standard 11" x 17" (tabloid-size) paper, and reassembled.

TO PRINT FULL SIZE SCHEMATIC DIAGRAMS

If you have access to a large paper plotter or printer capable of outputting the full-sized diagrams, output as follows:

- 1) Note the page size(s) of the schematics you want to output as indicated in the middle window at the bottom of the viewing screen.
- 2) Go to the File menu and select Print Set-up. Choose the printer name and driver for your large format printer. Confirm that the printer settings are set to output the indicated page size or larger.
- 3) Close the Print Set Up screen and return to the File menu. Select "Print..." Input the page number of the schematic(s) you want to print in the print range window. Choose OK.

TO PRINT TILED VERSION OF SCHEMATICS



Schematic pages that are larger than 11" x 17" full-size are provided in a 11" x 17" printable tiled format near the end of the document. These can be printed to tabloid-sized paper and assembled to full-size for easy viewing.

If you have access to a printer capable of outputting the tabloid size (11" x 17") paper, then output the tiled version of the diagram as follows:

- 1) Note the page number(s) of the schematics you want to output as indicated in the middle window at the bottom of the viewing screen.
- 2) Go to the File menu and select Print Set-up. Choose the printer name and driver for your printer. Confirm that the plotter settings are set to output 11" x 17", or tabloid size paper in landscape () mode.
- 3) Close the Print Set Up screen and return to the File menu. Select "Print..." Input the page number of the schematic(s) you want to print in the print range window. Choose OK.

TO PRINT SPECIFIC SECTIONS OF A SCHEMATIC

To print just a particular section of a PDF, rather than a full page, access the Graphics Select tool in the Acrobat Reader tool bar.

- 1) To view the Graphics Select Tool, press and HOLD the mouse button over the Text Select Tool which looks like: . This tool will expand to reveal to additional tools. Choose the Graphics Select tool by placing the cursor over the button on of the far right that looks like: 
- 2) After selecting the Graphics Select Tool, place your cursor in the document window and the cursor will change to a plus (+) symbol. Click and drag the cursor over the area you want to print. When you release the mouse button, a marquee (or dotted lined box) will be displayed outlining the area you selected.
- 3) With the marquee in place, go to the file menu and select the "Print..." option. When the print window appears, choose the option under the section called "Print Range" which says "Selected Graphic".

Select OK and the output will print only the area that you outlined with the marquee. 

(continued >)

ON-SCREEN SEARCH OPTION

All of the text within the service manual PDF is content searchable. This means that you can enter any text, word, phrase or reference number that appears in the manual, and the PDF software will search, find and move the cursor to the location where you requested text first appears. This feature can be particularly useful in locating components on a specific schematic or printed wire circuit board (PWB) diagrams.

Follow these steps to effectively locate a component on a schematic diagram:

- 1) Locate the schematic you want to search by clicking on the corresponding bookmark on the left side of the screen. The view on the right of the screen will then jump to the desired schematic page.
- 2) Magnify the diagram to at least 400% before conducting a component search. This will enable you to easily view the reference number when it is highlighted on screen. To do this, click on the magnifying glass button on the tool bar at the top of the screen. Move the cursor over the diagram and RIGHT click you mouse. Select the 400% magnification option on the pop-up menu. Click on the button with the icon of the open hand to deactivate the magnification tool
- 3) Search the diagram (or the entire manual) by clicking on the binocular button tool at the top of the screen. The "Find" window will appear and allow you to type in your desired text. Type in a reference designator, such as R502, and click on the "Find" button. If the component is not on the diagram, but is listed anywhere else in the manual, the cursor will jump to the first location the text is found in the file. To find another instance of that same text, click on the binocular button again and select "Find Again."